

Spring Batch - Reference Documentation

Spring Batch 2.0.4.RELEASE

Copyright © 2005-2009 Lucas Ward, Dave Syer, Thomas
Risberg, Robert Kasanicky, Dan Garrette, Wayne Lund

Copies of this document may be made for your own use and for distribution to others,
provided that you do not charge any fee for such copies and further provided that
each copy contains this Copyright Notice, whether distributed in print or electronically.

1. Spring Batch Introduction 1
1.1. Background 1
1.2. Usage Scenarios 2
1.3. Spring Batch Architecture 3
2. What's New in Spring Batch 2.0 4
2.1. Java 5 4
2.2. Chunk Oriented Processing 4
2.2.1. ItemProcessor 6
2.3. Configuration Enhancements 7
2.4. Meta Data Access Improvements 8
2.5. Non Sequential Step Execution 8
2.6. Scalability 9
2.6.1. Remote Chunking 9
2.6.2. Partitioning 10
3. The Domain Language of Batch 11
3.1. Job 11
3.1.1. JobInstance 12
3.1.2. JobParameters 13
3.1.3. JobExecution 13
3.2. Step 15
3.2.1. StepExecution 16
3.3. ExecutionContext 17
3.4. JobRepository 19
3.5. JobLauncher 19
3.6. Item Reader 19
3.7. Item Writer 19
3.8. Item Processor 20
3.9. Batch Namespace 20
4. Configuring and Running a Job 21
4.1. Configuring a Job 21
4.1.1. Restartability 21
4.1.2. Intercepting Job Execution 22
4.1.3. Inheriting from a Parent Job 23
4.1.4. JobFactory and Stateful Components in Steps 23
4.2. Configuring a JobRepository 23
4.2.1. Transaction Configuration for the JobRepository 24
4.2.2. Changing the Table Prefix 24
4.2.3. In-Memory Repository 25
4.2.4. Non-standard Database Types in a Repository 25
4.3. Configuring a JobLauncher 25
4.4. Running a Job 26
4.4.1. Running Jobs from the Command Line 27
4.4.2. Running Jobs from within a Web Container 28
4.5. Advanced Meta-Data Usage 29
4.5.1. Querying the Repository 30
4.5.2. JobOperator 30
4.5.3. JobParametersIncrementer 31
4.5.4. Stopping a Job 32
5. Configuring a Step 33

- 5.1. Chunk-Oriented Processing 33
 - 5.1.1. Configuring a Step 34
 - 5.1.2. Referencing a Standalone Step 34
 - 5.1.3. Inheriting from a Parent Step 35
 - 5.1.4. The Commit Interval 36
 - 5.1.5. Configuring a Step for Restart 36
 - 5.1.6. Configuring Skip Logic 38
 - 5.1.7. Configuring Fatal Exceptions 39
 - 5.1.8. Configuring Retry Logic 39
 - 5.1.9. Controlling Rollback 39
 - 5.1.10. Transaction Attributes 40
 - 5.1.11. Registering ItemStreams with the Step 40
 - 5.1.12. Intercepting Step Execution 41
- 5.2. TaskletStep 44
 - 5.2.1. TaskletAdapter 45
 - 5.2.2. Example Tasklet Implementation 45
- 5.3. Controlling Step Flow 46
 - 5.3.1. Sequential Flow 46
 - 5.3.2. Conditional Flow 47
 - 5.3.3. Configuring for Stop 49
 - 5.3.4. Programmatic Flow Decisions 50
 - 5.3.5. Split Flows 51
- 5.4. Late Binding of Job and Step Attributes 51
 - 5.4.1. Step Scope 52
- 6. ItemReaders and ItemWriters 53**
 - 6.1. ItemReader 53
 - 6.2. ItemWriter 53
 - 6.3. ItemProcessor 54
 - 6.3.1. Chaining ItemProcessors 55
 - 6.3.2. Filtering Records 56
 - 6.4. ItemStream 56
 - 6.5. The Delegate Pattern and Registering with the Step 57
 - 6.6. Flat Files 57
 - 6.6.1. The FieldSet 58
 - 6.6.2. FlatFileItemReader 58
 - 6.6.3. FlatFileItemWriter 66
 - 6.7. XML Item Readers and Writers 69
 - 6.7.1. StaxEventItemReader 71
 - 6.7.2. StaxEventItemWriter 72
 - 6.8. Multi-File Input 73
 - 6.9. Database 74
 - 6.9.1. Cursor Based ItemReaders 74
 - 6.9.2. Paging ItemReaders 78
 - 6.9.3. Database ItemWriters 80
 - 6.10. Reusing Existing Services 82
 - 6.11. Validating Input 83
 - 6.12. Preventing State Persistence 84
 - 6.13. Creating Custom ItemReaders and ItemWriters 84
 - 6.13.1. Custom ItemReader Example 84

- 6.13.2. Custom ItemWriter Example 86
- 7. Scaling and Parallel Processing 88**
 - 7.1. Multi-threaded Step 88
 - 7.2. Parallel Steps 89
 - 7.3. Remote Chunking 89
 - 7.4. Partitioning 90
 - 7.4.1. PartitionHandler 92
 - 7.4.2. StepExecutionSplitter 93
 - 7.4.3. Binding Input Data to Steps 94
- 8. Repeat 95**
 - 8.1. RepeatTemplate 95
 - 8.1.1. RepeatContext 96
 - 8.1.2. RepeatStatus 96
 - 8.2. Completion Policies 96
 - 8.3. Exception Handling 96
 - 8.4. Listeners 97
 - 8.5. Parallel Processing 97
 - 8.6. Declarative Iteration 97
- 9. Retry 99**
 - 9.1. RetryTemplate 99
 - 9.1.1. RetryContext 100
 - 9.1.2. RecoveryCallback 100
 - 9.1.3. Stateless Retry 100
 - 9.1.4. Stateful Retry 100
 - 9.2. Retry Policies 101
 - 9.3. Backoff Policies 102
 - 9.4. Listeners 102
 - 9.5. Declarative Retry 103
- 10. Unit Testing 104**
 - 10.1. Creating a Unit Test Class 104
 - 10.2. End-To-End Testing of Batch Jobs 104
 - 10.3. Testing Individual Steps 105
 - 10.4. Validating Output Files 105
 - 10.5. Mocking Domain Objects 105
- 11. Common Batch Patterns 107**
 - 11.1. Logging Item Processing and Failures 107
 - 11.2. Stopping a Job Manually for Business Reasons 107
 - 11.3. Adding a Footer Record 109
 - 11.3.1. Writing a Summary Footer 109
 - 11.4. Driving Query Based ItemReaders 110
 - 11.5. Multi-Line Records 111
 - 11.6. Executing System Commands 113
 - 11.7. Handling Step Completion When No Input is Found 113
 - 11.8. Passing Data to Future Steps 114
- A. List of ItemReaders and ItemWriters 116
 - A.1. Item Readers 116
 - A.2. Item Writers 116
- B. Meta-Data Schema 117
 - B.1. Overview 117

- B.1.1. Example DDL Scripts 117
- B.1.2. Version 118
- B.1.3. Identity 118
- B.2. BATCH_JOB_INSTANCE 118
- B.3. BATCH_JOB_PARAMS 119
- B.4. BATCH_JOB_EXECUTION 119
- B.5. BATCH_STEP_EXECUTION 120
- B.6. BATCH_JOB_EXECUTION_CONTEXT 122
- B.7. BATCH_STEP_EXECUTION_CONTEXT 122
- B.8. Archiving 122
- B.9. Recommendations for Indexing Meta Data Tables 123
- Glossary 124

Chapter 1. Spring Batch Introduction

Many applications within the enterprise domain require bulk processing to perform business operations in mission critical environments. These business operations include automated, complex processing of large volumes of information that is most efficiently processed without user interaction. These operations typically include time based events (e.g. month-end calculations, notices or correspondence), periodic application of complex business rules processed repetitively across very large data sets (e.g. Insurance benefit determination or rate adjustments), or the integration of information that is received from internal and external systems that typically requires formatting, validation and processing in a transactional manner into the system of record. Batch processing is used to process billions of transactions every day for enterprises.

Spring Batch is a lightweight, comprehensive batch framework designed to enable the development of robust batch applications vital for the daily operations of enterprise systems. Spring Batch builds upon the productivity, POJO-based development approach, and general ease of use capabilities people have come to know from the Spring Framework, while making it easy for developers to access and leverage more advance enterprise services when necessary. Spring Batch is not a scheduling framework. There are many good enterprise schedulers available in both the commercial and open source spaces such as Quartz, Tivoli, Control-M, etc. It is intended to work in conjunction with a scheduler, not replace a scheduler.

Spring Batch provides reusable functions that are essential in processing large volumes of records, including logging/tracing, transaction management, job processing statistics, job restart, skip, and resource management. It also provides more advance technical services and features that will enable extremely high-volume and high performance batch jobs though optimization and partitioning techniques. Simple as well as complex, high-volume batch jobs can leverage the framework in a highly scalable manner to process significant volumes of information.

1.1. Background

While open source software projects and associated communities have focused greater attention on web-based and SOA messaging-based architecture frameworks, there has been a notable lack of focus on reusable architecture frameworks to accommodate Java-based batch processing needs, despite continued needs to handle such processing within enterprise IT environments. The lack of a standard, reusable batch architecture has resulted in the proliferation of many one-off, in-house solutions developed within client enterprise IT functions.

SpringSource and Accenture have collaborated to change this. Accenture's hands-on industry and technical experience in implementing batch architectures, SpringSource's depth of technical experience, and Spring's proven programming model together mark a natural and powerful partnership to create high-quality, market relevant software aimed at filling an important gap in enterprise Java. Both companies are also currently working with a number of clients solving similar problems developing Spring-based batch architecture solutions. This has provided some useful additional detail and real-life constraints helping to ensure the solution can be applied to the real-world problems posed by clients. For these reasons and many more, SpringSource and Accenture have teamed to collaborate on the development of Spring Batch.

Accenture has contributed previously proprietary batch processing architecture frameworks, based upon decades worth of experience in building batch architectures with the last several generations of

platforms, (i.e., COBOL/Mainframe, C++/Unix, and now Java/anywhere) to the Spring Batch project along with committer resources to drive support, enhancements, and the future roadmap.

The collaborative effort between Accenture and SpringSource aims to promote the standardization of software processing approaches, frameworks, and tools that can be consistently leveraged by enterprise users when creating batch applications. Companies and government agencies desiring to deliver standard, proven solutions to their enterprise IT environments will benefit from Spring Batch.

1.2. Usage Scenarios

A typical batch program generally reads a large number of records from a database, file, or queue, processes the data in some fashion, and then writes back data in a modified form. Spring Batch automates this basic batch iteration, providing the capability to process similar transactions as a set, typically in an offline environment without any user interaction. Batch jobs are part of most IT projects and Spring Batch is the only open source framework that provides a robust, enterprise-scale solution.

Business Scenarios

- Commit batch process periodically
- Concurrent batch processing: parallel processing of a job
- Staged, enterprise message-driven processing
- Massively parallel batch processing
- Manual or scheduled restart after failure
- Sequential processing of dependent steps (with extensions to workflow-driven batches)
- Partial processing: skip records (e.g. on rollback)
- Whole-batch transaction: for cases with a small batch size or existing stored procedures/scripts

Technical Objectives

- Batch developers use the Spring programming model: concentrate on business logic; let the framework take care of infrastructure.
- Clear separation of concerns between the infrastructure, the batch execution environment, and the batch application.
- Provide common, core execution services as interfaces that all projects can implement.
- Provide simple and default implementations of the core execution interfaces that can be used 'out of the box'.
- Easy to configure, customize, and extend services, by leveraging the spring framework in all layers.
- All existing core services should be easy to replace or extend, without any impact to the infrastructure layer.
- Provide a simple deployment model, with the architecture JARs completely separate from the application, built using Maven.

1.3. Spring Batch Architecture

Spring Batch is designed with extensibility and a diverse group of end users in mind. The figure below shows a sketch of the layered architecture that supports the extensibility and ease of use for end-user developers.

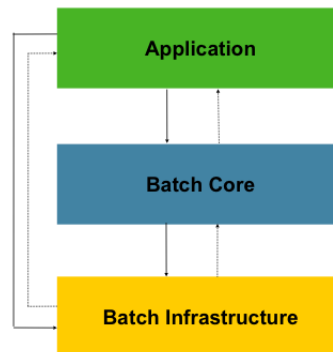

Figure 1.1: Spring Batch Layered Architecture

This layered architecture highlights three major high level components: Application, Core, and Infrastructure. The application contains all batch jobs and custom code written by developers using Spring Batch. The Batch Core contains the core runtime classes necessary to launch and control a batch job. It includes things such as a `JobLauncher`, `Job`, and `Step` implementations. Both Application and Core are built on top of a common infrastructure. This infrastructure contains common readers and writers, and services such as the `RetryTemplate`, which are used both by application developers (`ItemReader` and `ItemWriter`) and the core framework itself. (`retry`)

Chapter 2. What's New in Spring Batch 2.0

The Spring Batch 2.0 release has six major themes:

- Java 5
- Non Sequential Step Execution
- Chunk oriented processing
- Meta Data enhancements
- Scalability
- Configuration

2.1. Java 5

The 1.x releases of Spring Batch were all based on Java 1.4. This prevented the framework from using many enhancements provided in Java 5 such as generics, parameterized types, etc. The entire framework has been updated to utilize these features. As a result, **Java 1.4 is no longer supported**. Most of the interfaces developers work with have been updated to support generic types. As an example, the `ItemReader` interface from 1.1 is below:

```
public interface ItemReader {  
  
    Object read() throws Exception;  
  
    void mark() throws MarkFailedException;  
  
    void reset() throws ResetFailedException;  
}
```

As you can see, the `read` method returns an `Object`. The 2.0 version is below:

```
public interface ItemReader<T> {  
  
    T read() throws Exception, UnexpectedInputException, ParseException;  
  
}
```

As you can see, `ItemReader` now supports the generic type, `T`, which is returned from `read`. You may also notice that `mark` and `reset` have been removed. This is due to step processing strategy changes, which are discussed below. Many other interfaces have been similarly updated.

2.2. Chunk Oriented Processing

Previously, the default processing strategy provided by Spring Batch was item-oriented processing:

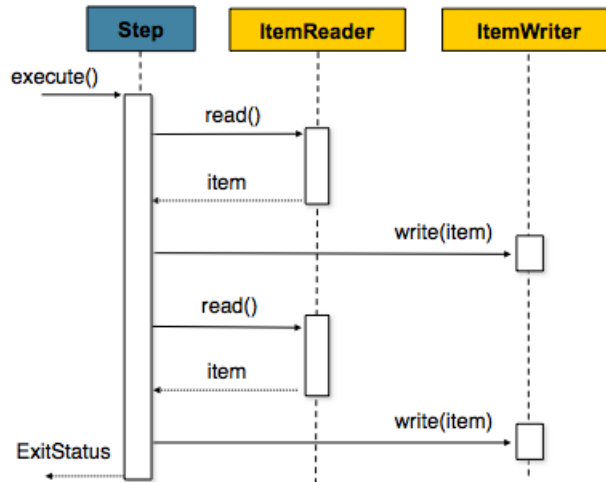

In item-oriented processing, the `ItemReader` returns one `Object` (the 'item') which is then handed to the `ItemWriter`, periodically committing when the number of items hits the commit interval. For example, if the commit interval is 5, `ItemReader` and `ItemWriter` will each be called 5 times. This is illustrated in a simplified code example below:

```

for(int i = 0; i < commitInterval; i++){
    Object item = itemReader.read();
    itemWriter.write(item);
}
  
```

Both the `ItemReader` and `ItemWriter` interfaces were completely geared toward this approach:

```

public interface ItemReader {

    Object read() throws Exception;

    void mark() throws MarkFailedException;

    void reset() throws ResetFailedException;

}
  
```

```

public interface ItemWriter {

    void write(Object item) throws Exception;

    void flush() throws FlushFailedException;

    void clear() throws ClearFailedException;

}
  
```

Because the 'scope' of the processing was one item, supporting rollback scenarios required additional methods, which is what `mark`, `reset`, `flush`, and `clear` provided. If, after successfully reading and writing 2 items, the third has an error while writing, the transaction would need to be rolled back. In this case, the `clear` method on the writer would be called, indicating that it should `clear` its buffer, and `reset` would be called on the `ItemReader`, indicating that it should return back to the last position it was at when `mark` was called. (Both `mark` and `flush` are called on commit)

In 2.0, this strategy has been changed to a chunk-oriented approach:

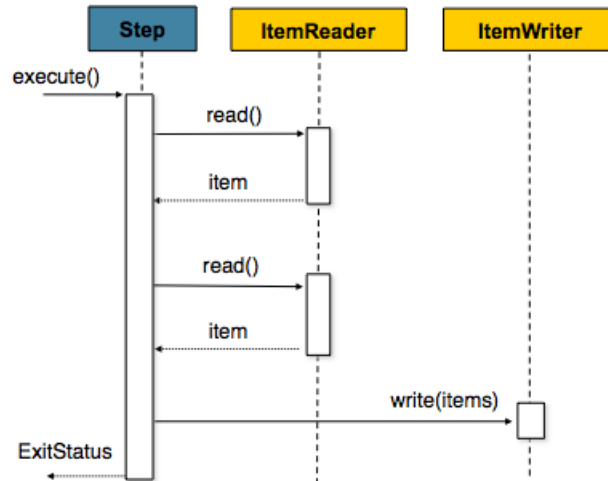

Using the same example from above, if the commit interval is five, read will be called 5 times, and write once. The items read will be aggregated into a list, that will ultimately be written out, as the simplified example below illustrates:

```

List items = new ArrayList();
for(int i = 0; i < commitInterval; i++){
    items.add(itemReader.read());
}
itemWriter.write(items);
  
```

This approach not only allows for much simpler processing and scalability approaches, it also makes the `ItemReader` and `ItemWriter` interfaces much cleaner:

```

public interface ItemReader<T> {

    T read() throws Exception, UnexpectedInputException, ParseException;

}
  
```

```

public interface ItemWriter<T> {

    void write(List<? extends T> items) throws Exception;

}
  
```

As you can see, the interfaces no longer contain the `mark`, `reset`, `flush`, and `clear` methods. This makes the creation of readers and writers much more straightforward for developers. In the case of `ItemReader`, the interface is now forward-only. The framework will buffer read items for developers in the case of rollback (though there are exceptions if the underlying resource is transactional see: Section 5.1.9.1, “Transactional Readers”). `ItemWriter` is also simplified, since it gets the entire 'chunk' of items at once, rather than one at a time, it can decide to flush any resources (such as a file or hibernate session) before returning control to the `Step`. More detailed information on chunk-oriented processing can be found in Section 5.1, “Chunk-Oriented Processing”. Reader and writer implementation information can be found in Chapter 6, *ItemReaders and ItemWriters*.

2.2.1. ItemProcessor

Previously, `Steps` had only two dependencies, `ItemReader` and `ItemWriter`:

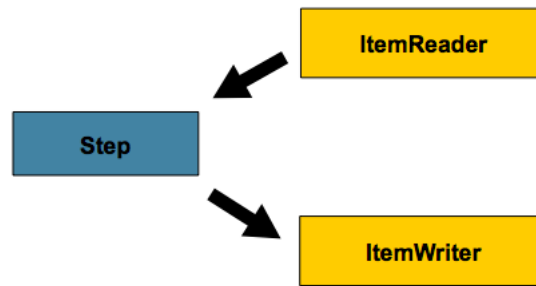

The basic configuration above is fairly robust. However, there are many cases where the item needs to be transformed before writing. In 1.x this can be achieved using the composite pattern:

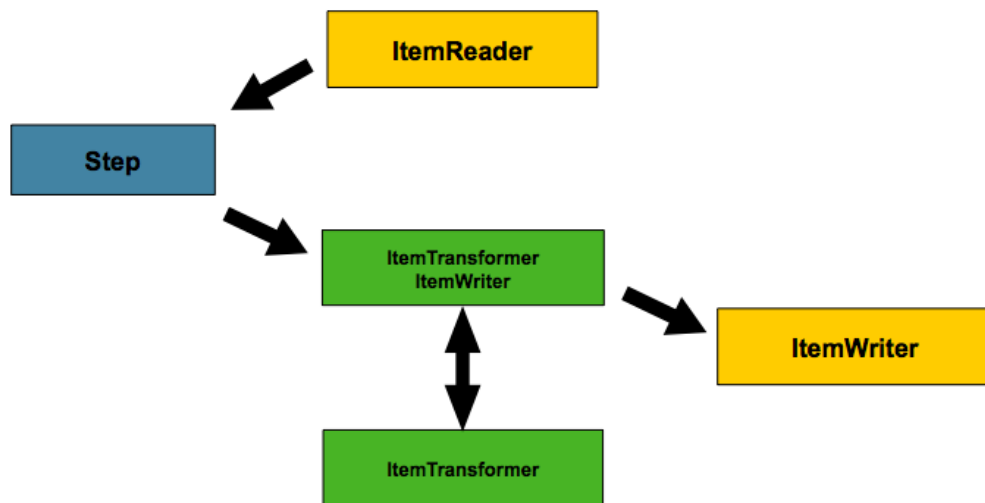

This approach works. However, it requires an extra layer between either the reader or the writer and the Step. Furthermore, the `ItemWriter` would need to be registered separately as an `ItemStream` with the Step. For this reason, the `ItemTransformer` was renamed to `ItemProcessor` and moved up to the same level as `ItemReader` and `ItemWriter`:

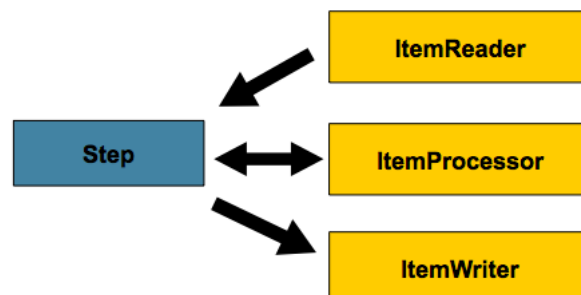

2.3. Configuration Enhancements

Until 2.0, the only option for configuring batch jobs has been normal spring bean configuration. However, in 2.0 there is a new namespace for configuration. For example, in 1.1, configuring a job looked like the following:

```

<bean id="footballJob"
  class="org.springframework.batch.core.job.SimpleJob">
  <property name="steps">
    <list>
      <!-- Step bean details omitted for clarity -->
      <bean id="playerload"/>
    </list>
  </property>
</bean>
  
```

```

        <bean id="gameLoad"/>
        <bean id="playerSummarization"/>
    </list>
</property>
<property name="jobRepository" ref="jobRepository" />
</bean>

```

In 2.0, the equivalent would be:

```

<job id="footballJob">
  <!-- Step bean details omitted for clarity -->
  <step id="playerload" next="gameLoad"/>
  <step id="gameLoad" next="playerSummarization"/>
  <step id="playerSummarization"/>
</job>

```

More information on how to configure Jobs and Steps with the new namespace can be found in Chapter 4, *Configuring and Running a Job*, and Chapter 5, *Configuring a Step*.

2.4. Meta Data Access Improvements

The `JobRepository` interface represents basic CRUD operations with `Job` meta-data. However, it may also be useful to query the meta-data. For that reason, the `JobExplorer` and `JobOperator` interfaces have been created:

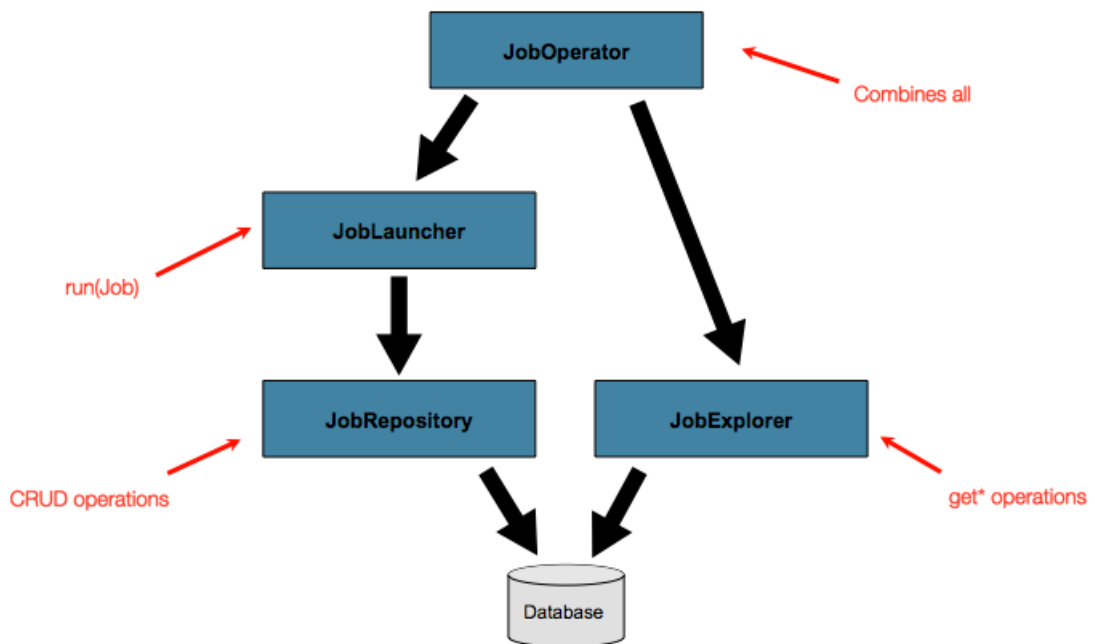

More information on the new meta data features can be found in Section 4.5, “Advanced Meta-Data Usage”. It is also worth noting that Jobs can now be stopped via the database, removing the requirement to maintain a handle to the `JobExecution` on the JVM the job was launched in.

2.5. Non Sequential Step Execution

2.0 has also seen improvements in how steps can be configured. Rather than requiring that they solely be sequential:

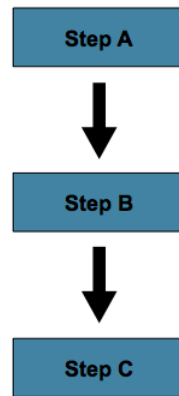

They may now be conditional:

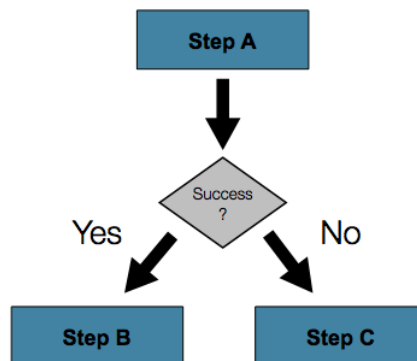

This new 'conditional flow' support is made easy to configure via the new namespace:

```

<job id="job">
  <step id="stepA">
    <next on="FAILED" to="stepB" />
    <next on="*" to="stepC" />
  </step>
  <step id="stepB" next="stepC" />
  <step id="stepC" />
</job>
  
```

More details on how to configure non sequential steps can be found in Section 5.3, “Controlling Step Flow”.

2.6. Scalability

Spring Batch 1.x was always intended as a single VM, possibly multi-threaded model, but many features were built into it that support parallel execution in multiple processes. Many projects have successfully implemented a scalable solution relying on the quality of service features of Spring Batch to ensure that processing only happens in the correct sequence. In 2.0 those features have been exposed more explicitly. There are two approaches to scalability: remote chunking, and partitioning.

2.6.1. Remote Chunking

Remote chunking is a technique for dividing up the work of a step without any explicit knowledge of the structure of the data. Any input source can be split up dynamically by reading it in a single process (as per normal in 1.x) and sending the items as a chunk to a remote worker process. The remote process implements a listener pattern, responding to the request, processing the data and sending an asynchronous reply. The transport for the request and reply has to be durable with guaranteed

delivery and a single consumer, and those features are readily available with any JMS implementation. But Spring Batch is building the remote chunking feature on top of Spring Integration, therefore it is agnostic to the actual implementation of the message middleware. More details can be found in Section 7.3, “Remote Chunking”

2.6.2. Partitioning

Partitioning is an alternative approach which in contrast depends on having some knowledge of the structure of the input data, like a range of primary keys, or the name of a file to process. The advantage of this model is that the processors of each element in a partition can act as if they are a single step in a normal Spring Batch job. They don't have to implement any special or new patterns, which makes them easy to configure and test. Partitioning in principle is more scalable than remote chunking because there is no serialization bottleneck arising from reading all the input data in one place.

In Spring Batch 2.0 partitioning is supported by two interfaces: `PartitionHandler` and `StepExecutionSplitter`. The `PartitionHandler` is the one that knows about the execution fabric - it has to transmit requests to remote steps and collect the results using whatever grid or remoting technology is available. `PartitionHandler` is an SPI, and Spring Batch provides one implementation out of the box for local execution through a `TaskExecutor`. This will be useful immediately when parallel processing of heavily IO bound tasks is required, since in those cases remote execution only complicates the deployment and doesn't necessarily help much with the performance. Other implementations will be specific to the execution fabric. (e.g. one of the grid providers such as IBM, Oracle, Terracotta, Appistry etc.), Spring Batch makes no preference for any of grid provider over another. More details can be found in Section 7.4, “Partitioning”

Chapter 3. The Domain Language of Batch

To any experienced batch architect, the overall concepts of batch processing used in Spring Batch should be familiar and comfortable. There are “Jobs” and “Steps” and developer supplied processing units called ItemReaders and ItemWriters. However, because of the Spring patterns, operations, templates, callbacks, and idioms, there are opportunities for the following:

- significant improvement in adherence to a clear separation of concerns
- clearly delineated architectural layers and services provided as interfaces
- simple and default implementations that allow for quick adoption and ease of use out-of-the-box
- significantly enhanced extensibility

The diagram below is simplified version of the batch reference architecture that has been used for decades. It provides an overview of the components that make up the domain language of batch processing. This architecture framework is a blueprint that has been proven through decades of implementations on the last several generations of platforms (COBOL/Mainframe, C++/Unix, and now Java/anywhere). JCL and COBOL developers are likely to be as comfortable with the concepts as C++, C# and Java developers. Spring Batch provides a physical implementation of the layers, components and technical services commonly found in robust, maintainable systems used to address the creation of simple to complex batch applications, with the infrastructure and extensions to address very complex processing needs.

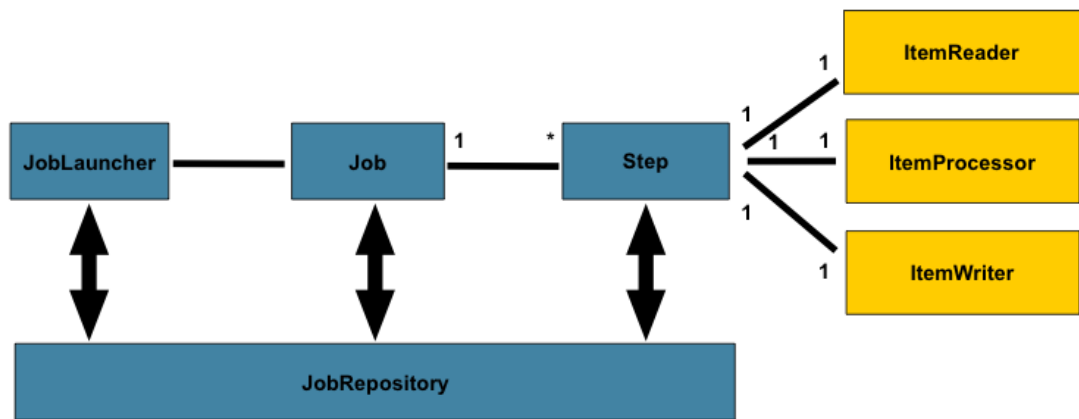
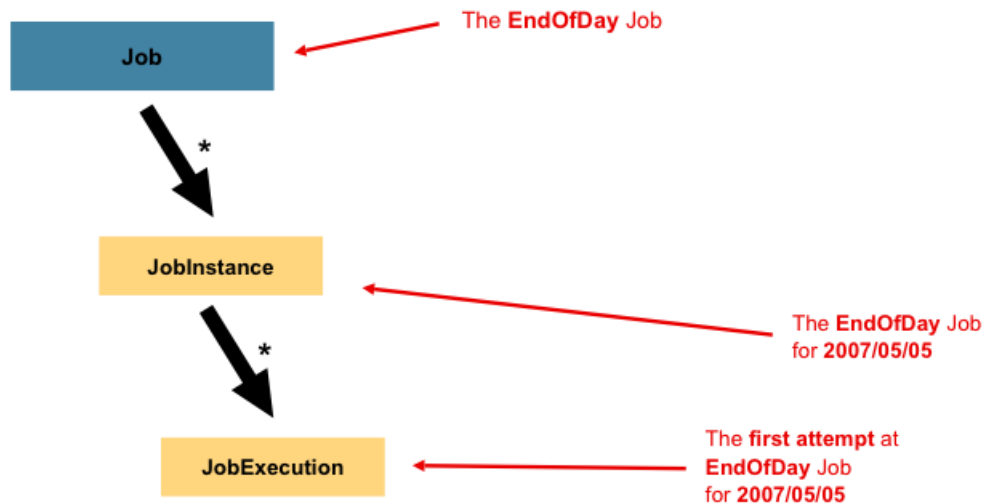

Figure 2.1: Batch Stereotypes

The diagram above highlights the key concepts that make up the domain language of batch. A Job has one to many steps, which has exactly one ItemReader, ItemProcessor, and ItemWriter. A job needs to be launched (JobLauncher), and meta data about the currently running process needs to be stored (JobRepository).

3.1. Job

This section describes stereotypes relating to the concept of a batch job. A `Job` is an entity that encapsulates an entire batch process. As is common with other Spring projects, a `Job` will be wired together via an XML configuration file. This file may be referred to as the "job configuration". However, `Job` is just the top of an overall hierarchy:



In Spring Batch, a `Job` is simply a container for Steps. It combines multiple steps that belong logically together in a flow and allows for configuration of properties global to all steps, such as restartability. The job configuration contains:

- The simple name of the job
- Definition and ordering of Steps
- Whether or not the job is restartable

A default simple implementation of the `Job` interface is provided by Spring Batch in the form of the `SimpleJob` class which creates some standard functionality on top of `Job`, however the batch namespace abstracts away the need to instantiate it directly. Instead, the `<job>` tag can be used:

```

<job id="footballJob">
  <step id="playerload" next="gameLoad"/>
  <step id="gameLoad" next="playerSummarization"/>
  <step id="playerSummarization"/>
</job>
  
```

3.1.1. JobInstance

A `JobInstance` refers to the concept of a logical job run. Let's consider a batch job that should be run once at the end of the day, such as the 'EndOfDay' job from the diagram above. There is one 'EndOfDay' `Job`, but each individual run of the `Job` must be tracked separately. In the case of this job, there will be one logical `JobInstance` per day. For example, there will be a January 1st run, and a January 2nd run. If the January 1st run fails the first time and is run again the next day, it is still the January 1st run. (Usually this corresponds with the data it is processing as well, meaning the January 1st run processes data for January 1st, etc). Therefore, each `JobInstance` can have multiple executions (`JobExecution` is discussed in more detail below) and only one `JobInstance` corresponding to a particular `Job` and `JobParameters` can be running at a given time.

The definition of a `JobInstance` has absolutely no bearing on the data that will be loaded. It is entirely up to the `ItemReader` implementation used to determine how data will be loaded. For example, in the EndOfDay scenario, there may be a column on the data that indicates the 'effective date' or 'schedule date' to which the data belongs. So, the January 1st run would only load data from the 1st, and the January 2nd run would only use data from the 2nd. Because this determination will likely be a business

decision, it is left up to the `ItemReader` to decide. What using the same `JobInstance` will determine, however, is whether or not the 'state' (i.e. the `ExecutionContext`, which is discussed below) from previous executions will be used. Using a new `JobInstance` will mean 'start from the beginning' and using an existing instance will generally mean 'start from where you left off'.

3.1.2. JobParameters

Having discussed `JobInstance` and how it differs from `Job`, the natural question to ask is: "how is one `JobInstance` distinguished from another?" The answer is: `JobParameters`. `JobParameters` is a set of parameters used to start a batch job. They can be used for identification or even as reference data during the run:

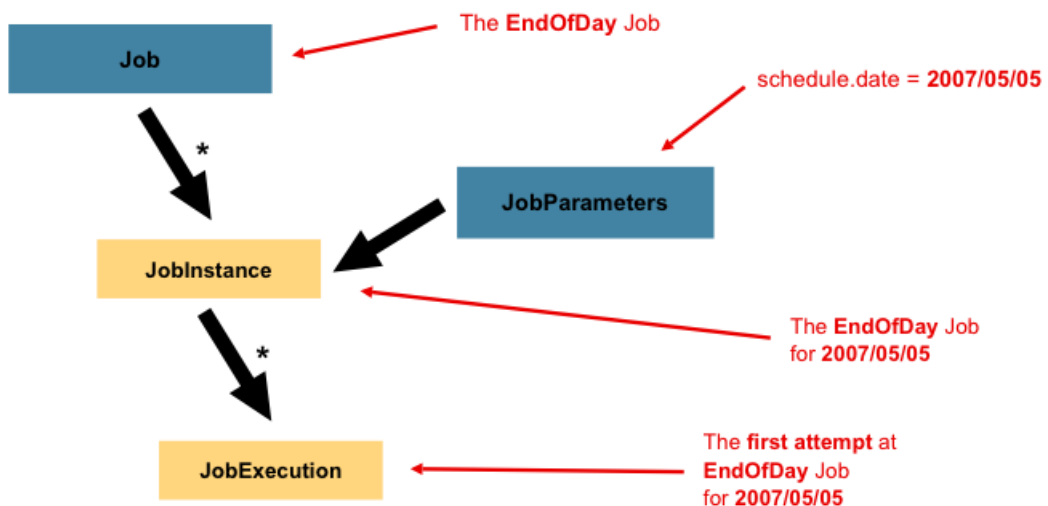

In the example above, where there are two instances, one for January 1st, and another for January 2nd, there is really only one `Job`, one that was started with a job parameter of 01-01-2008 and another that was started with a parameter of 01-02-2008. Thus, the contract can be defined as: `JobInstance = Job + JobParameters`. This allows a developer to effectively control how a `JobInstance` is defined, since they control what parameters are passed in.

3.1.3. JobExecution

A `JobExecution` refers to the technical concept of a single attempt to run a `Job`. An execution may end in failure or success, but the `JobInstance` corresponding to a given execution will not be considered complete unless the execution completes successfully. Using the `EndOfDay Job` described above as an example, consider a `JobInstance` for 01-01-2008 that failed the first time it was run. If it is run again with the same job parameters as the first run (01-01-2008), a new `JobExecution` will be created. However, there will still be only one `JobInstance`.

A `Job` defines what a job is and how it is to be executed, and `JobInstance` is a purely organizational object to group executions together, primarily to enable correct restart semantics. A `JobExecution`, however, is the primary storage mechanism for what actually happened during a run, and as such contains many more properties that must be controlled and persisted:

Table 3.1. JobExecution Properties

status	A <code>BatchStatus</code> object that indicates the status of the execution. While running, it's <code>BatchStatus.STARTED</code> , if it fails, it's <code>BatchStatus.FAILED</code> , and if it finishes successfully, it's <code>BatchStatus.COMPLETED</code>
startTime	A <code>java.util.Date</code> representing the current system time when the execution was started.
endTime	A <code>java.util.Date</code> representing the current system time when the execution finished, regardless of whether or not it was successful.
exitStatus	The <code>ExitStatus</code> indicating the result of the run. It is most important because it contains an exit code that will be returned to the caller. See chapter 5 for more details.
createTime	A <code>java.util.Date</code> representing the current system time when the <code>JobExecution</code> was first persisted. The job may not have been started yet (and thus has no start time), but it will always have a <code>createTime</code> , which is required by the framework for managing job level <code>ExecutionContexts</code> .
lastUpdated	A <code>java.util.Date</code> representing the last time a <code>JobExecution</code> was persisted.
executionContext	The 'property bag' containing any user data that needs to be persisted between executions.
failureExceptions	The list of exceptions encountered during the execution of a <code>Job</code> . These can be useful if more than one exception is encountered during the failure of a <code>Job</code> .

These properties are important because they will be persisted and can be used to completely determine the status of an execution. For example, if the `EndOfDay` job for 01-01 is executed at 9:00 PM, and fails at 9:30, the following entries will be made in the batch meta data tables:

Table 3.2. BATCH_JOB_INSTANCE

JOB_INST_ID	JOB_NAME
1	EndOfDayJob

Table 3.3. BATCH_JOB_PARAMS

JOB_INST_ID	TYPE_CD	KEY_NAME	DATE_VAL
1	DATE	schedule.Date	2008-01-01

Table 3.4. BATCH_JOB_EXECUTION

JOB_EXEC_ID	JOB_INST_ID	START_TIME	END_TIME	STATUS
1	1	2008-01-01 21:00	2008-01-01 21:30	FAILED

**Note**

column names may have been abbreviated or removed for clarity and formatting

Now that the job has failed, let's assume that it took the entire course of the night for the problem to be determined, so that the 'batch window' is now closed. Assuming the window starts at 9:00 PM, the job will be kicked off again for 01-01, starting where it left off and completing successfully at 9:30.

Because it's now the next day, the 01-02 job must be run as well, which is kicked off just afterwards at 9:31, and completes in its normal one hour time at 10:30. There is no requirement that one `JobInstance` be kicked off after another, unless there is potential for the two jobs to attempt to access the same data, causing issues with locking at the database level. It is entirely up to the scheduler to determine when a `Job` should be run. Since they're separate `JobInstances`, Spring Batch will make no attempt to stop them from being run concurrently. (Attempting to run the same `JobInstance` while another is already running will result in a `JobExecutionAlreadyRunningException` being thrown). There should now be an extra entry in both the `JobInstance` and `JobParameters` tables, and two extra entries in the `JobExecution` table:

Table 3.5. BATCH_JOB_INSTANCE

JOB_INST_ID	JOB_NAME
1	EndOfDayJob
2	EndOfDayJob

Table 3.6. BATCH_JOB_PARAMS

JOB_INST_ID	TYPE_CD	KEY_NAME	DATE_VAL
1	DATE	schedule.Date	2008-01-01 00:00:00
2	DATE	schedule.Date	2008-01-02 00:00:00

Table 3.7. BATCH_JOB_EXECUTION

JOB_EXEC_ID	JOB_INST_ID	START_TIME	END_TIME	STATUS
1	1	2008-01-01 21:00	2008-01-01 21:30	FAILED
2	1	2008-01-02 21:00	2008-01-02 21:30	COMPLETED
3	2	2008-01-02 21:31	2008-01-02 22:29	COMPLETED

**Note**

column names may have been abbreviated or removed for clarity and formatting

3.2. Step

A `Step` is a domain object that encapsulates an independent, sequential phase of a batch job. Therefore, every `Job` is composed entirely of one or more steps. A `Step` contains all of the information necessary to define and control the actual batch processing. This is a necessarily vague description because the contents of any given `Step` are at the discretion of the developer writing a `Job`. A `Step` can be as simple or complex as the developer desires. A simple `Step` might load data from a file into the database, requiring little or no code. (depending upon the implementations used) A more complex `Step` may have complicated business rules that are applied as part of the processing. As with `Job`, a `Step` has an individual `StepExecution` that corresponds with a unique `JobExecution`:

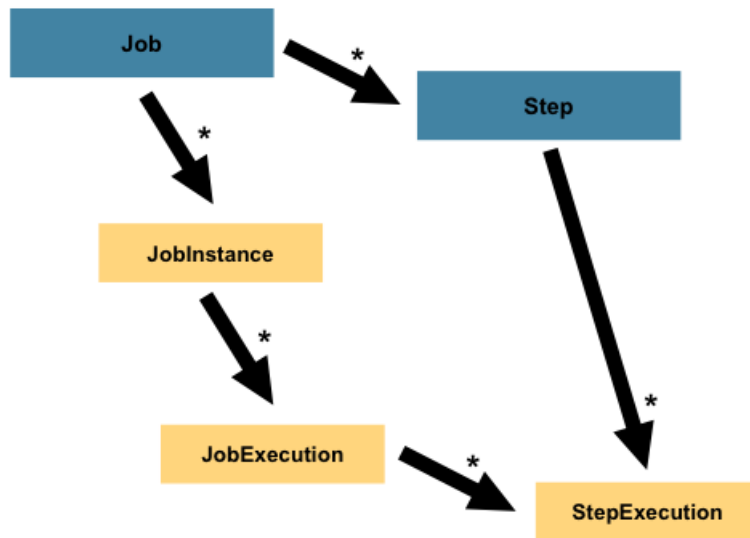

3.2.1. StepExecution

A `StepExecution` represents a single attempt to execute a `Step`. A new `StepExecution` will be created each time a `Step` is run, similar to `JobExecution`. However, if a step fails to execute because the step before it fails, there will be no execution persisted for it. A `StepExecution` will only be created when its `Step` is actually started.

Step executions are represented by objects of the `StepExecution` class. Each execution contains a reference to its corresponding `Step` and `JobExecution`, and transaction related data such as commit and rollback count and start and end times. Additionally, each step execution will contain an `ExecutionContext`, which contains any data a developer needs persisted across batch runs, such as statistics or state information needed to restart. The following is a listing of the properties for `StepExecution`:

Table 3.8. StepExecution Properties

status	A <code>BatchStatus</code> object that indicates the status of the execution. While it's running, the status is <code>BatchStatus.STARTED</code> , if it fails, the status is <code>BatchStatus.FAILED</code> , and if it finishes successfully, the status is <code>BatchStatus.COMPLETED</code>
startTime	A <code>java.util.Date</code> representing the current system time when the execution was started.
endTime	A <code>java.util.Date</code> representing the current system time when the execution finished, regardless of whether or not it was successful.
exitStatus	The <code>ExitStatus</code> indicating the result of the execution. It is most important because it contains an exit code that will be returned to the caller. See chapter 5 for more details.
executionContext	The 'property bag' containing any user data that needs to be persisted between executions.
readCount	The number of items that have been successfully read
writeCount	The number of items that have been successfully written
commitCount	The number transactions that have been committed for this execution
rollbackCount	The number of times the business transaction controlled by the <code>Step</code> has been rolled back.
readSkipCount	The number of times <code>read</code> has failed, resulting in a skipped item.
processSkipCount	The number of times <code>process</code> has failed, resulting in a skipped item.
filterCount	The number of items that have been 'filtered' by the <code>ItemProcessor</code> .
writeSkipCount	The number of times <code>write</code> has failed, resulting in a skipped item.

3.3. ExecutionContext

An `ExecutionContext` represents a collection of key/value pairs that are persisted and controlled by the framework in order to allow developers a place to store persistent state that is scoped to a `StepExecution` or `JobExecution`. For those familiar with Quartz, it is very similar to `JobDataMap`. The best usage example is to facilitate restart. Using flat file input as an example, while processing individual lines, the framework periodically persists the `ExecutionContext` at commit points. This allows the `ItemReader` to store its state in case a fatal error occurs during the run, or even if the power goes out. All that is needed is to put the current number of lines read into the context, and the framework will do the rest:

```
executionContext.putLong(getKey(LINES_READ_COUNT), reader.getPosition());
```

Using the `EndOfDay` example from the Job Stereotypes section as an example, assume there's one step: 'loadData', that loads a file into the database. After the first failed run, the meta data tables would look like the following:

Table 3.9. BATCH_JOB_INSTANCE

JOB_INST_ID	JOB_NAME
1	EndOfDayJob

Table 3.10. BATCH_JOB_PARAMS

JOB_INST_ID	TYPE_CD	KEY_NAME	DATE_VAL
1	DATE	schedule.Date	2008-01-01

Table 3.11. BATCH_JOB_EXECUTION

JOB_EXEC_ID	JOB_INST_ID	START_TIME	END_TIME	STATUS
1	1	2008-01-01 21:00	2008-01-01 21:30	FAILED

Table 3.12. BATCH_STEP_EXECUTION

STEP_EXEC_ID	JOB_EXEC_ID	STEP_NAME	START_TIME	END_TIME	STATUS
1	1	loadDate	2008-01-01 21:00	2008-01-01 21:30	FAILED

Table 3.13. BATCH_STEP_EXECUTION_CONTEXT

STEP_EXEC_ID	SHORT_CONTEXT
1	{piece.count=40321}

In this case, the `Step` ran for 30 minutes and processed 40,321 'pieces', which would represent lines in a file in this scenario. This value will be updated just before each commit by the framework, and can contain multiple rows corresponding to entries within the `ExecutionContext`. Being notified before a commit requires one of the various `StepListeners`, or an `ItemStream`, which are discussed in more detail later in this guide. As with the previous example, it is assumed that the `Job` is restarted the next day. When it is restarted, the values from the `ExecutionContext` of the last run are reconstituted from the database, and when the `ItemReader` is opened, it can check to see if it has any stored state in the context, and initialize itself from there:

```

if (executionContext.containsKey(getKey(LINES_READ_COUNT))) {
    log.debug("Initializing for restart. Restart data is: " + executionContext);

    long lineCount = executionContext.getLong(getKey(LINES_READ_COUNT));

    LineReader reader = getReader();

    Object record = "";
    while (reader.getPosition() < lineCount && record != null) {
        record = readLine();
    }
}

```

In this case, after the above code is executed, the current line will be 40,322, allowing the `Step` to start again from where it left off. The `ExecutionContext` can also be used for statistics that need to be persisted about the run itself. For example, if a flat file contains orders for processing that exist across multiple lines, it may be necessary to store how many orders have been processed (which is much different from than the number of lines read) so that an email can be sent at the end of the `Step` with the total orders processed in the body. The framework handles storing this for the developer, in order to correctly scope it with an individual `JobInstance`. It can be very difficult to know whether an existing `ExecutionContext` should be used or not. For example, using the 'EndOfDay' example from above, when the 01-01 run starts again for the second time, the framework recognizes that it is the same `JobInstance` and on an individual `Step` basis, pulls the `ExecutionContext` out of the database and

hands it as part of the `StepExecution` to the `Step` itself. Conversely, for the 01-02 run the framework recognizes that it is a different instance, so an empty context must be handed to the `Step`. There are many of these types of determinations that the framework makes for the developer to ensure the state is given to them at the correct time. It is also important to note that exactly one `ExecutionContext` exists per `StepExecution` at any given time. Clients of the `ExecutionContext` should be careful because this creates a shared key space, so care should be taken when putting values in to ensure no data is overwritten. However, the `Step` stores absolutely no data in the context, so there is no way to adversely affect the framework.

It is also important to note that there is at least one `ExecutionContext` per `JobExecution`, and one for every `StepExecution`. For example, consider the following code snippet:

```
ExecutionContext ecStep = stepExecution.getExecutionContext();
ExecutionContext ecJob = jobExecution.getExecutionContext();
//ecStep does not equal ecJob
```

As noted in the comment, `ecStep` will not equal `ecJob`; they are two different `ExecutionContexts`. The one scoped to the `Step` will be saved at every commit point in the `Step`, whereas the one scoped to the `Job` will be saved in between every `Step` execution.

3.4. JobRepository

`JobRepository` is the persistence mechanism for all of the Stereotypes mentioned above. It provides CRUD operations for `JobLauncher`, `Job`, and `Step` implementations. When a `Job` is first launched, a `JobExecution` is obtained from the repository, and during the course of execution `StepExecution` and `JobExecution` implementations are persisted by passing them to the repository:

```
<job-repository id="jobRepository"/>
```

3.5. JobLauncher

`JobLauncher` represents a simple interface for launching a `Job` with a given set of `JobParameters`:

```
public interface JobLauncher {

    public JobExecution run(Job job, JobParameters jobParameters)
        throws JobExecutionAlreadyRunningException, JobRestartException;

}
```

It is expected that implementations will obtain a valid `JobExecution` from the `JobRepository` and execute the `Job`.

3.6. Item Reader

`ItemReader` is an abstraction that represents the retrieval of input for a `Step`, one item at a time. When the `ItemReader` has exhausted the items it can provide, it will indicate this by returning null. More details about the `ItemReader` interface and its various implementations can be found in Chapter 6, *ItemReaders and ItemWriters*.

3.7. Item Writer

`ItemWriter` is an abstraction that represents the output of a `Step`, one item at a time. Generally, an item writer has no knowledge of the input it will receive next, only the item that was passed in its current

invocation. More details about the `ItemWriter` interface and its various implementations can be found in Chapter 6, *ItemReaders and ItemWriters*.

3.8. Item Processor

`ItemProcessor` is an abstraction that represents the business processing of an item. While the `ItemReader` reads one item, and the `ItemWriter` writes them, the `ItemProcessor` provides access to transform or apply other business processing. If, while processing the item, it is determined that the item is not valid, returning null indicates that the item should not be written out. More details about the `ItemProcessor` interface can be found in Chapter 6, *ItemReaders and ItemWriters*.

3.9. Batch Namespace

Many of the domain concepts listed above need to be configured in a Spring `ApplicationContext`. While there are implementations of the interfaces above that can be used in a standard bean definition, a namespace has been provided for ease of configuration:

```
<beans:beans xmlns="http://www.springframework.org/schema/batch"
  xmlns:beans="http://www.springframework.org/schema/beans"
  xmlns:xsi="http://www.w3.org/2001/XMLSchema-instance"
  xsi:schemaLocation="
    http://www.springframework.org/schema/beans
    http://www.springframework.org/schema/beans/spring-beans-2.0.xsd
    http://www.springframework.org/schema/batch
    http://www.springframework.org/schema/batch/spring-batch-2.0.xsd">

  <job id="ioSampleJob">
    <step id="step1">
      <tasklet>
        <chunk reader="itemReader" writer="itemWriter" commit-interval="2"/>
      </tasklet>
    </step>
  </job>

</beans:beans>
```

As long as the batch namespace has been declared, any of its elements can be used. More information on configuring a `Job` can be found in Chapter 4, *Configuring and Running a Job*. More information on configuring a `Step` can be found in Chapter 5, *Configuring a Step*.

Chapter 4. Configuring and Running a Job

In Batch Domain Language , the overall architecture design was discussed, using the following diagram as a guide:

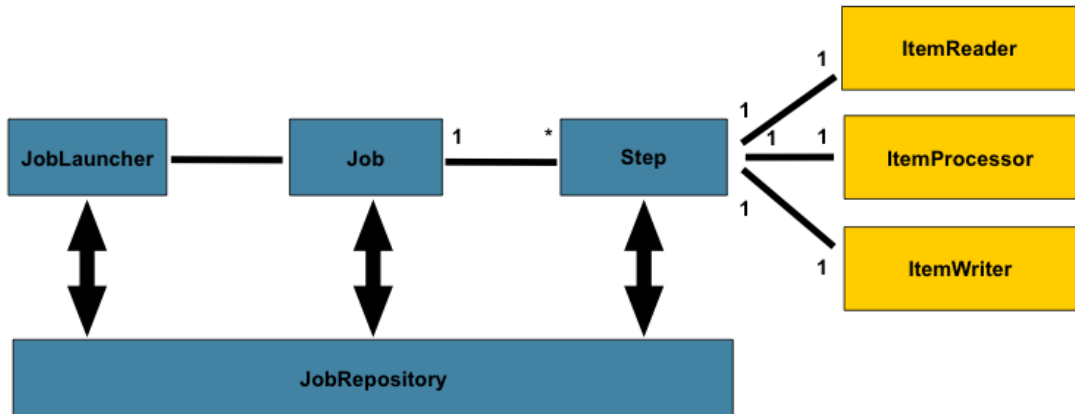

While the `Job` object may seem like a simple container for steps, there are many configuration options of which a developers must be aware . Furthermore, there are many considerations for how a `Job` will be run and how its meta-data will be stored during that run. This chapter will explain the various configuration options and runtime concerns of a `Job` .

4.1. Configuring a Job

There are multiple implementations of the `Job` interface, however, the namespace abstracts away the differences in configuration. It has only three required dependencies: a name, `JobRepository` , and a list of `Step` s.

```
<job id="footballJob">
  <step id="playerload"          parent="s1" next="gameLoad"/>
  <step id="gameLoad"           parent="s2" next="playerSummarization"/>
  <step id="playerSummarization" parent="s3"/>
</job>
```

The namespace defaults to referencing a repository with an id of 'jobRepository', which is a sensible default. However, this can be overridden explicitly:

```
<job id="footballJob" job-repository="specialRepository">
  <step id="playerload"          parent="s1" next="gameLoad"/>
  <step id="gameLoad"           parent="s3" next="playerSummarization"/>
  <step id="playerSummarization" parent="s3"/>
</job>
```

4.1.1. Restartability

One key issue when executing a batch job concerns the behavior of a `Job` when it is restarted? The launching of a `Job` is considered to be a 'restart' if a `JobExecution` already exists for the particular `JobInstance`. Ideally, all jobs should be able to start up where they left off, but there are scenarios where this is not possible. **It is entirely up to the developer to ensure that a new `JobInstance` is created in this scenario.** However, Spring Batch does provide some help. If a `Job` should never be restarted, but should always be run as part of a new `JobInstance`, then the restartable property may be set to 'false':

```
<job id="footballJob" restartable="false">
```

```
...
</job>
```

To phrase it another way, setting `restartable` to `false` means "this Job does not support being started again". Restarting a Job that is not restartable will cause a `JobRestartException` to be thrown:

```
Job job = new SimpleJob();
job.setRestartable(false);

JobParameters jobParameters = new JobParameters();

JobExecution firstExecution = jobRepository.createJobExecution(job, jobParameters);
jobRepository.saveOrUpdate(firstExecution);

try {
    jobRepository.createJobExecution(job, jobParameters);
    fail();
}
catch (JobRestartException e) {
    // expected
}
```

This snippet of JUnit code shows how attempting to create a `JobExecution` the first time for a non restartable job will cause no issues. However, the second attempt will throw a `JobRestartException`.

4.1.2. Intercepting Job Execution

During the course of the execution of a `Job`, it may be useful to be notified of various events in its lifecycle so that custom code may be executed. The `SimpleJob` allows for this by calling a `JobListener` at the appropriate time:

```
public interface JobExecutionListener {

    void beforeJob(JobExecution jobExecution);

    void afterJob(JobExecution jobExecution);

}
```

`JobListeners` can be added to a `SimpleJob` via the `listeners` element on the job:

```
<job id="footballJob">
  <step id="playerload"          parent="s1" next="gameLoad"/>
  <step id="gameLoad"           parent="s2" next="playerSummarization"/>
  <step id="playerSummarization" parent="s3"/>
  <listeners>
    <listener class="org.springframework.batch.sample.SampleListener"/>
  </listeners>
</job>
```

It should be noted that `afterJob` will be called regardless of the success or failure of the `Job`. If success or failure needs to be determined it can be obtained from the `JobExecution`:

```
public void afterJob(JobExecution jobExecution){
    if( jobExecution.getStatus() == BatchStatus.COMPLETED ){
        //job success
    }
    else if(jobExecution.getStatus() == BatchStatus.FAILED){
        //job failure
    }
}
```

The annotations corresponding to this interface are:

- `@BeforeJob`
- `@AfterJob`

4.1.3. Inheriting from a Parent Job

If a group of `Jobs` share similar, but not identical, configurations, then it may be helpful to define a "parent" `Job` from which the concrete `Jobs` may inherit properties. Similar to class inheritance in Java, the "child" `Job` will combine its elements and attributes with the parent's.

In the following example, "baseJob" is an abstract `Job` definition that defines only a list of listeners. The `Job` "job1" is a concrete definition that inherits the list of listeners from "baseJob" and merges it with its own list of listeners to produce a `Job` with two listeners and one `Step`, "step1".

```
<job id="baseJob" abstract="true">
  <listeners>
    <listener class="com.ListenerOne"/>
  </listeners>
</job>

<job id="job1" parent="baseJob3">
  <step id="step1" parent="standaloneStep"/>

  <listeners merge="true">
    <listener class="com.ListenerTwo"/>
  </listeners>
</job>
```

Please see the section on Inheriting from a Parent Step for more detailed information.

4.1.4. JobFactory and Stateful Components in Steps

Unlike many traditional Spring applications, many of the components of a batch application are stateful; the file readers and writers are obvious examples. The recommended way to deal with this is to create a fresh `ApplicationContext` for each job execution. If the `Job` is launched from the command line with `CommandLineJobRunner`, this is trivial. For more complex launching scenarios where jobs are executed in parallel or serially from the same process, some extra steps have to be taken to ensure that the `ApplicationContext` is refreshed. This is preferable to using prototype scope for the stateful beans because then they would not receive lifecycle callbacks from the container at the end of use. (e.g. through `destroy-method` in XML)

The strategy provided by Spring Batch to deal with this scenario is the `JobFactory`, and the samples provide an example of a specialized implementation that can load an `ApplicationContext` and close it properly when the job is finished. A relevant examples is `ClassPathXmlApplicationContextJobFactory` and its use in the `adhoc-job-launcher-context.xml` and the `quartz-job-launcher-context.xml`, which can be found in the Samples project.

4.2. Configuring a JobRepository

As described in earlier, the `JobRepository` is used for basic CRUD operations of the various persisted domain objects within Spring Batch, such as `JobExecution` and `StepExecution`. It is required by many of the major framework features, such as the `JobLauncher`, `Job`, and `Step`. The batch namespace abstracts away many of the implementation details of the `JobRepository` implementations and their collaborators. However, there are still a few configuration options available:

```
<job-repository id="jobRepository"
  dataSource="dataSource"
  transactionManager="transactionManager"
  isolation-level-for-create="SERIALIZABLE"
  table-prefix="BATCH_"
/>
```

None of the configuration options listed above are required except the id. If they are not set, the defaults shown above will be used. They are shown above for awareness purposes.

4.2.1. Transaction Configuration for the JobRepository

If the namespace is used, transactional advice will be automatically created around the repository. This is to ensure that the batch meta data, including state that is necessary for restarts after a failure, is persisted correctly. The behavior of the framework is not well defined if the repository methods are not transactional. The isolation level in the `create*` method attributes is specified separately to ensure that when jobs are launched, if two processes are trying to launch the same job at the same time, only one will succeed. The default isolation level for that method is `SERIALIZABLE`, which is quite aggressive: `READ_COMMITTED` would work just as well; `READ_UNCOMMITTED` would be fine if two processes are not likely to collide in this way. However, since a call to the `create*` method is quite short, it is unlikely that the `SERIALIZED` will cause problems, as long as the database platform supports it. However, this can be overridden:

```
<job-repository id="jobRepository"
  isolation-level-for-create="REPEATABLE_READ" />
```

If the namespace or factory beans aren't used then it is also essential to configure the transactional behavior of the repository using AOP:

```
<aop:config>
  <aop:advisor
    pointcut="execution(* org.springframework.batch.core.*Repository+.*(..))"/>
  <advice-ref="txAdvice" />
</aop:config>

<tx:advice id="txAdvice" transaction-manager="transactionManager">
  <tx:attributes>
    <tx:method name="*" />
  </tx:attributes>
</tx:advice>
```

This fragment can be used as is, with almost no changes. Remember also to include the appropriate namespace declarations and to make sure `spring-tx` and `spring-aop` (or the whole of `spring`) are on the classpath.

4.2.2. Changing the Table Prefix

Another modifiable property of the `JobRepository` is the table prefix of the meta-data tables. By default they are all prefaced with `BATCH_`. `BATCH_JOB_EXECUTION` and `BATCH_STEP_EXECUTION` are two examples. However, there are potential reasons to modify this prefix. If the schema names needs to be prepended to the table names, or if more than one set of meta data tables is needed within the same schema, then the table prefix will need to be changed:

```
<job-repository id="jobRepository"
  table-prefix="SYSTEM.TEST_" />
```

Given the above changes, every query to the meta data tables will be prefixed with "SYSTEM.TEST_". BATCH_JOB_EXECUTION will be referred to as SYSTEM.TEST_JOB_EXECUTION.



Note

Only the table prefix is configurable. The table and column names are not.

4.2.3. In-Memory Repository

There are scenarios in which you may not want to persist your domain objects to the database. One reason may be speed; storing domain objects at each commit point takes extra time. Another reason may be that you just don't need to persist status for a particular job. For this reason, Spring batch provides an in-memory Map version of the job repository:

```
<bean id="jobRepository"
  class="org.springframework.batch.core.repository.support.MapJobRepositoryFactoryBean">
  <property name="transactionManager" ref="transactionManager"/>
</bean>
```

Note that the in-memory repository is volatile and so does not allow restart between JVM instances. It also cannot guarantee that two job instances with the same parameters are launched simultaneously, and is not suitable for use in a multi-threaded Job, or a locally partitioned Step. So use the database version of the repository wherever you need those features.

However it does require a transaction manager to be defined because there are rollback semantics within the repository, and because the business logic might still be transactional (e.g. RDBMS access). For testing purposes many people find the `ResourcelessTransactionManager` useful.

4.2.4. Non-standard Database Types in a Repository

If you are using a database platform that is not in the list of supported platforms, you may be able to use one of the supported types, if the SQL variant is close enough. To do this you can use the raw `JobRepositoryFactoryBean` instead of the namespace shortcut and use it to set the database type to the closest match:

```
<bean id="jobRepository" class="org...JobRepositoryFactoryBean">
  <property name="databaseType" value="db2"/>
  <property name="dataSource" ref="dataSource"/>
</bean>
```

(The `JobRepositoryFactoryBean` tries to auto-detect the database type from the `DataSource` if it is not specified.) The major differences between platforms are mainly accounted for by the strategy for incrementing primary keys, so often it might be necessary to override the `incrementerFactory` as well (using one of the standard implementations from the Spring Framework).

If even that doesn't work, or you are not using an RDBMS, then the only option may be to implement the various `Dao` interfaces that the `SimpleJobRepository` depends on and wire one up manually in the normal Spring way.

4.3. Configuring a JobLauncher

The most basic implementation of the `JobLauncher` interface is the `SimpleJobLauncher`. Its only required dependency is a `JobRepository`, in order to obtain an execution:

```
<bean id="jobLauncher"
```

```

class="org.springframework.batch.core.launch.support.SimpleJobLauncher">
  <property name="jobRepository" ref="jobRepository" />
</bean>

```

Once a `JobExecution` is obtained, it is passed to the `execute` method of `Job`, ultimately returning the `JobExecution` to the caller:

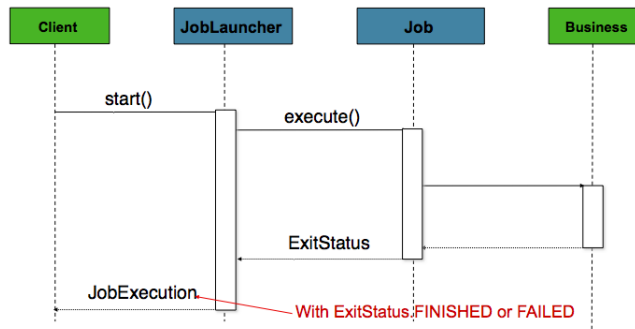

The sequence is straightforward and works well when launched from a scheduler. However, issues arise when trying to launch from an HTTP request. In this scenario, the launching needs to be done asynchronously so that the `SimpleJobLauncher` returns immediately to its caller. This is because it is not good practice to keep an HTTP request open for the amount of time needed by long running processes such as batch. An example sequence is below:

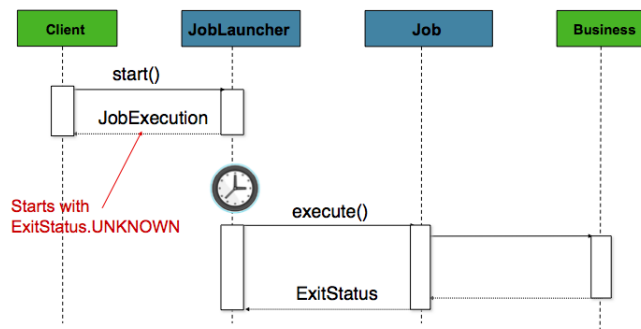

The `SimpleJobLauncher` can easily be configured to allow for this scenario by configuring a `TaskExecutor`:

```

<bean id="jobLauncher"
  class="org.springframework.batch.core.launch.support.SimpleJobLauncher">
  <property name="jobRepository" ref="jobRepository" />
  <property name="taskExecutor">
    <bean class="org.springframework.core.task.SimpleAsyncTaskExecutor" />
  </property>
</bean>

```

Any implementation of the spring `TaskExecutor` interface can be used to control how jobs are asynchronously executed.

4.4. Running a Job

At a minimum, launching a batch job requires two things: the `Job` to be launched and a `JobLauncher`. Both can be contained within the same context or different contexts. For example, if launching a job from the command line, a new JVM will be instantiated for each `Job`, and thus every job will have its own `JobLauncher`. However, if running from within a web container within the scope of an `HttpRequest`, there will usually be one `JobLauncher`, configured for asynchronous job launching, that multiple requests will invoke to launch their jobs.

4.4.1. Running Jobs from the Command Line

For users that want to run their jobs from an enterprise scheduler, the command line is the primary interface. This is because most schedulers (with the exception of Quartz unless using the `NativeJob`) work directly with operating system processes, primarily kicked off with shell scripts. There are many ways to launch a Java process besides a shell script, such as Perl, Ruby, or even 'build tools' such as ant or maven. However, because most people are familiar with shell scripts, this example will focus on them.

4.4.1.1. The CommandLineJobRunner

Because the script launching the job must kick off a Java Virtual Machine, there needs to be a class with a main method to act as the primary entry point. Spring Batch provides an implementation that serves just this purpose: `CommandLineJobRunner`. It's important to note that this is just one way to bootstrap your application, but there are many ways to launch a Java process, and this class should in no way be viewed as definitive. The `CommandLineJobRunner` performs four tasks:

- Load the appropriate `ApplicationContext`
- Parse command line arguments into `JobParameters`
- Locate the appropriate job based on arguments
- Use the `JobLauncher` provided in the application context to launch the job.

All of these tasks are accomplished using only the arguments passed in. The following are required arguments:

Table 4.1. CommandLineJobRunner arguments

<code>jobPath</code>	The location of the XML file that will be used to create an <code>ApplicationContext</code> . This file should contain everything needed to run the complete <code>Job</code>
<code>jobName</code>	The name of the job to be run.

These arguments must be passed in with the path first and the name second. All arguments after these are considered to be `JobParameters` and must be in the format of 'name=value':

```
bash$ java CommandLineJobRunner endOfDayJob.xml endOfDay schedule.date(date)=2008/01/01
```

In most cases you would want to use a manifest to declare your main class in a jar, but for simplicity, the class was used directly. This example is using the same 'EndOfDay' example from Batch Domain Language. The first argument is 'endOfDayJob.xml', which is the Spring `ApplicationContext` containing the `Job`. The second argument, 'endOfDay' represents the job name. The final argument, 'schedule.date(date)=2008/01/01' will be converted into `JobParameters`. An example of the XML configuration is below:

```
<job id="endOfDay">
  <step id="step1" parent="simpleStep" />
</job>

<!-- Launcher details removed for clarity -->
```



```
<beans:bean id="jobLauncher"  
    class="org.springframework.batch.core.launch.support.SimpleJobLauncher" />
```

This example is overly simplistic, since there are many more requirements to run a batch job in Spring Batch in general, but it serves to show the two main requirements of the `CommandLineJobRunner`: `Job` and `JobLauncher`.

4.4.1.2. ExitCodes

When launching a batch job from the command-line, an enterprise scheduler is often used. Most schedulers are fairly dumb and work only at the process level. This means that they only know about some operating system process such as a shell script that they're invoking. In this scenario, the only way to communicate back to the scheduler about the success or failure of a job is through return codes. A return code is a number that is returned to a scheduler by the process that indicates the result of the run. In the simplest case: 0 is success and 1 is failure. However, there may be more complex scenarios: If job A returns 4 kick off job B, and if it returns 5 kick off job C. This type of behavior is configured at the scheduler level, but it is important that a processing framework such as Spring Batch provide a way to return a numeric representation of the 'Exit Code' for a particular batch job. In Spring Batch this is encapsulated within an `ExitStatus`, which is covered in more detail in Chapter 5. For the purposes of discussing exit codes, the only important thing to know is that an `ExitStatus` has an exit code property that is set by the framework (or the developer) and is returned as part of the `JobExecution` returned from the `JobLauncher`. The `CommandLineJobRunner` converts this string value to a number using the `ExitCodeMapper` interface:

```
public interface ExitCodeMapper {  
  
    public int intValue(String exitCode);  
  
}
```

The essential contract of an `ExitCodeMapper` is that, given a string exit code, a number representation will be returned. The default implementation used by the job runner is the `SimpleJvmExitCodeMapper` that returns 0 for completion, 1 for generic errors, and 2 for any job runner errors such as not being able to find a `Job` in the provided context. If anything more complex than the 3 values above is needed, then a custom implementation of the `ExitCodeMapper` interface must be supplied. Because the `CommandLineJobRunner` is the class that creates an `ApplicationContext`, and thus cannot be 'wired together', any values that need to be overwritten must be autowired. This means that if an implementation of `ExitCodeMapper` is found within the `BeanFactory`, it will be injected into the runner after the context is created. All that needs to be done to provide your own `ExitCodeMapper` is to declare the implementation as a root level bean and ensure that it is part of the `ApplicationContext` that is loaded by the runner.

4.4.2. Running Jobs from within a Web Container

Historically, offline processing such as batch jobs have been launched from the command-line, as described above. However, there are many cases where launching from an `HttpRequest` is a better option. Many such use cases include reporting, ad-hoc job running, and web application support. Because a batch job by definition is long running, the most important concern is ensuring to launch the job asynchronously:

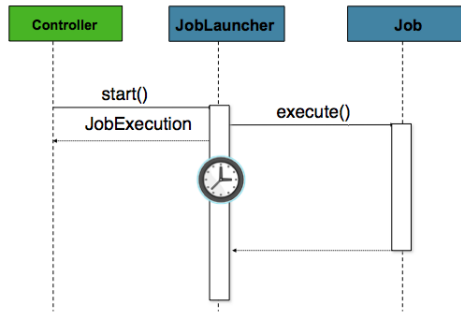

The controller in this case is a Spring MVC controller. More information on Spring MVC can be found here: <http://static.springframework.org/spring/docs/2.5.x/reference/mvc.html>. The controller launches a Job using a JobLauncher that has been configured to launch asynchronously, which immediately returns a JobExecution. The Job will likely still be running, however, this nonblocking behaviour allows the controller to return immediately, which is required when handling an HttpRequest. An example is below:

```

@Controller
public class JobLauncherController {

    @Autowired
    JobLauncher jobLauncher;

    @Autowired
    Job job;

    @RequestMapping("/jobLauncher.html")
    public void handle() throws Exception{
        jobLauncher.run(job, new JobParameters());
    }
}

```

4.5. Advanced Meta-Data Usage

So far, both the JobLauncher and JobRepository interfaces have been discussed. Together, they represent simple launching of a job, and basic CRUD operations of batch domain objects:

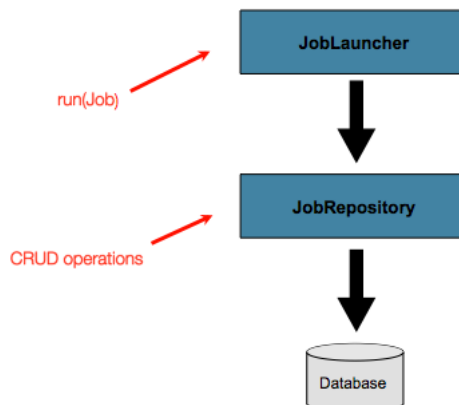

A JobLauncher uses the JobRepository to create new JobExecution objects and run them. Job and Step implementations later use the same JobRepository for basic updates of the same executions during the running of a Job. The basic operations suffice for simple scenarios, but in a large batch environment with hundreds of batch jobs and complex scheduling requirements, more advanced access of the meta data is required:

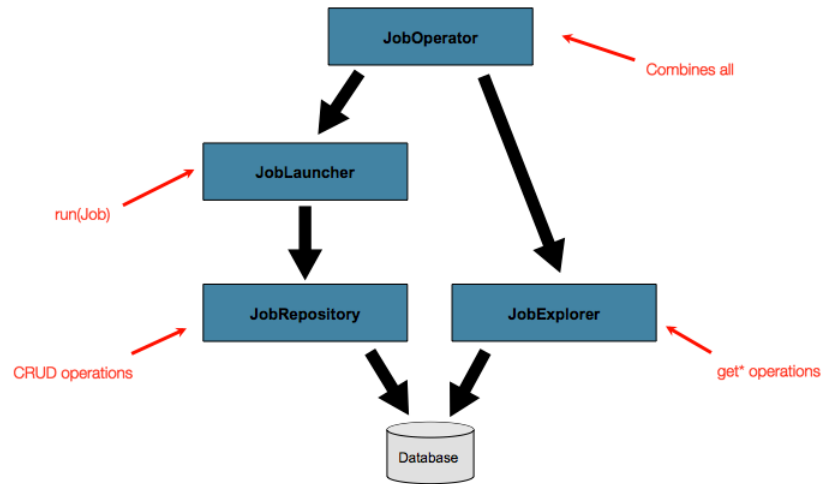

The `JobExplorer` and `JobOperator` interfaces, which will be discussed below, add additional functionality for querying and controlling the meta data.

4.5.1. Querying the Repository

The most basic need before any advanced features is the ability to query the repository for existing executions. This functionality is provided by the `JobExplorer` interface:

```

public interface JobExplorer {

    List<JobInstance> getJobInstances(String jobName, int start, int count);

    JobExecution getJobExecution(Long executionId);

    StepExecution getStepExecution(Long jobExecutionId, Long stepExecutionId);

    JobInstance getJobInstance(Long instanceId);

    List<JobExecution> getJobExecutions(JobInstance jobInstance);

    Set<JobExecution> findRunningJobExecutions(String jobName);

}
  
```

As is evident from the method signatures above, `JobExplorer` is a read-only version of the `JobRepository`, and like the `JobRepository`, it can be easily configured via a factory bean:

```

<bean id="jobExplorer" class="org.spr...JobExplorerFactoryBean"
      p:dataSource-ref="dataSource" />
  
```

Earlier in this chapter, it was mentioned that the table prefix of the `JobRepository` can be modified to allow for different versions or schemas. Because the `JobExplorer` is working with the same tables, it too needs the ability to set a prefix:

```

<bean id="jobExplorer" class="org.spr...JobExplorerFactoryBean"
      p:dataSource-ref="dataSource" p:tablePrefix="BATCH_" />
  
```

4.5.2. JobOperator

As previously discussed, the `JobRepository` provides CRUD operations on the meta-data, and the `JobExplorer` provides read-only operations on the meta-data. However, those operations are most useful when used together to perform common monitoring tasks such as stopping, restarting, or

summarizing a Job, as is commonly done by batch operators. Spring Batch provides for these types of operations via the `JobOperator` interface:

```
public interface JobOperator {

    List<Long> getExecutions(long instanceId) throws NoSuchJobInstanceException;

    List<Long> getJobInstances(String jobName, int start, int count)
        throws NoSuchJobException;

    Set<Long> getRunningExecutions(String jobName) throws NoSuchJobException;

    String getParameters(long executionId) throws NoSuchJobExecutionException;

    Long start(String jobName, String parameters)
        throws NoSuchJobException, JobInstanceAlreadyExistsException;

    Long restart(long executionId)
        throws JobInstanceAlreadyCompleteException, NoSuchJobExecutionException,
            NoSuchJobException, JobRestartException;

    Long startNextInstance(String jobName)
        throws NoSuchJobException, JobParametersNotFoundException, JobRestartException,
            JobExecutionAlreadyRunningException, JobInstanceAlreadyCompleteException;

    boolean stop(long executionId)
        throws NoSuchJobExecutionException, JobExecutionNotRunningException;

    String getSummary(long executionId) throws NoSuchJobExecutionException;

    Map<Long, String> getStepExecutionSummaries(long executionId)
        throws NoSuchJobExecutionException;

    Set<String> getJobNames();

}
```

The above operations represent methods from many different interfaces, such as `JobLauncher`, `JobRepository`, `JobExplorer`, and `JobRegistry`. For this reason, the provided implementation of `JobOperator`, `SimpleJobOperator`, has many dependencies:

```
<bean id="jobOperator" class="org.spr...SimpleJobOperator">
  <property name="jobExplorer">
    <bean class="org.spr...JobExplorerFactoryBean">
      <property name="dataSource" ref="dataSource" />
    </bean>
  </property>
  <property name="jobRepository" ref="jobRepository" />
  <property name="jobRegistry" ref="jobRegistry" />
  <property name="jobLauncher" ref="jobLauncher" />
</bean>
```

4.5.3. JobParametersIncrementer

Most of the methods on `JobOperator` are self-explanatory, and more detailed explanations can be found on the [javadoc of the interface](#). However, the `startNextInstance` method is worth noting. This method will always start a new instance of a Job. This can be extremely useful if there are serious issues in a `JobExecution` and the Job needs to be started over again from the beginning. Unlike `JobLauncher` though, which requires a new `JobParameters` object that will trigger a new `JobInstance` if the parameters are different from any previous set of parameters, the `startNextInstance` method will use the `JobParametersIncrementer` tied to the Job to force the Job to a new instance:

```
public interface JobParametersIncrementer {

    JobParameters getNext(JobParameters parameters);

}
```

The contract of `JobParametersIncrementer` is that, given a `JobParameters` object, it will return the 'next' `JobParameters` object by incrementing any necessary values it may contain. This strategy is useful because the framework has no way of knowing what changes to the `JobParameters` make it the 'next' instance. For example, if the only value in `JobParameters` is a date, and the next instance should be created, should that value be incremented by one day? Or one week (if the job is weekly for instance)? The same can be said for any numerical values that help to identify the `Job`, as shown below:

```
public class SampleIncrementer implements JobParametersIncrementer {

    public JobParameters getNext(JobParameters parameters) {
        if (parameters==null || parameters.isEmpty()) {
            return new JobParametersBuilder().addLong("run.id", 1L).toJobParameters();
        }
        long id = parameters.getLong("run.id",1L) + 1;
        return new JobParametersBuilder().addLong("run.id", id).toJobParameters();
    }

}
```

In this example, the value with a key of 'run.id' is used to discriminate between `Job` instances. If the `JobParameters` passed in is null, it can be assumed that the `Job` has never been run before and thus its initial state can be returned. However, if not, the old value is obtained, incremented by one, and returned. An incrementer can be associated with `Job` via the 'incrementer' attribute in the namespace:

```
<job id="footballJob" incrementer="sampleIncrementer">
    ...
</job>
```

4.5.4. Stopping a Job

One of the most common use cases of `JobOperator` is gracefully stopping a `Job`:

```
Set<Long> executions = jobOperator.getRunningExecutions("sampleJob");
jobOperator.stop(executions.iterator().next());
```

The shutdown is not immediate, since there is no way to force immediate shutdown, especially if the execution is currently in developer code that the framework has no control over, such as a business service. However, as soon as control is returned back to the framework, it will set the status of the current `StepExecution` to `BatchStatus.STOPPED`, save it, then do the same for the `JobExecution` before finishing.

Chapter 5. Configuring a Step

As discussed in Batch Domain Language, a `Step` is a domain object that encapsulates an independent, sequential phase of a batch job and contains all of the information necessary to define and control the actual batch processing. This is a necessarily vague description because the contents of any given `Step` are at the discretion of the developer writing a `Job`. A `Step` can be as simple or complex as the developer desires. A simple `Step` might load data from a file into the database, requiring little or no code. (depending upon the implementations used) A more complex `Step` may have complicated business rules that are applied as part of the processing.

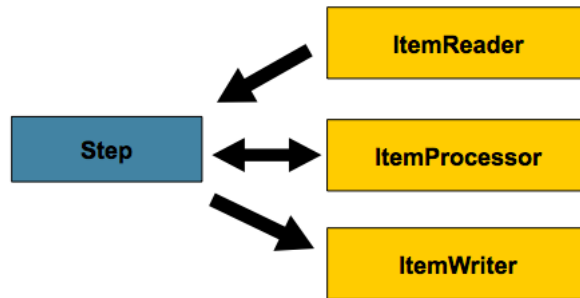

5.1. Chunk-Oriented Processing

Spring Batch uses a 'Chunk Oriented' processing style within its most common implementation. Chunk oriented processing refers to reading the data one at a time, and creating 'chunks' that will be written out, within a transaction boundary. One item is read in from an `ItemReader`, handed to an `ItemProcessor`, and aggregated. Once the number of items read equals the commit interval, the entire chunk is written out via the `ItemWriter`, and then the transaction is committed.

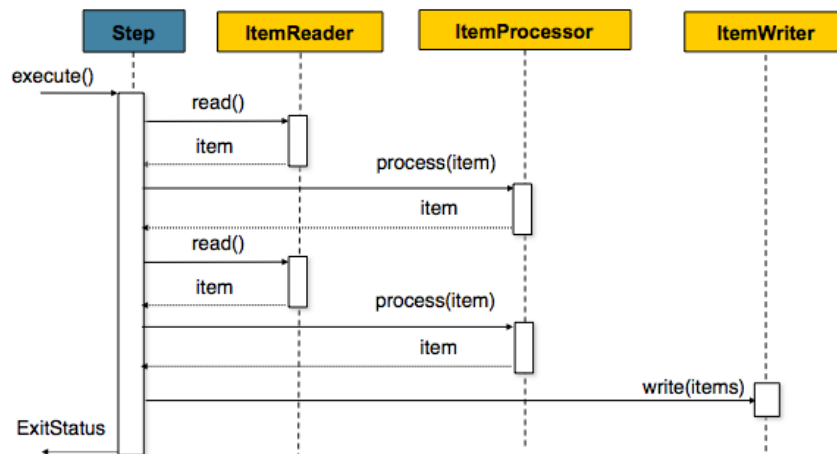

Below is a code representation of the same concepts shown above:

```
List items = new ArrayList();
for(int i = 0; i < commitInterval; i++){
    Object item = itemReader.read()
    Object processedItem = itemProcessor.process(item);
    items.add(processedItem);
}
itemWriter.write(items);
```

5.1.1. Configuring a Step

Despite the relatively short list of required dependencies for a `Step`, it is an extremely complex class that can potentially contain many collaborators. In order to ease configuration, the Spring Batch namespace can be used:

```
<job id="sampleJob" job-repository="jobRepository">
  <step id="step1">
    <tasklet transaction-manager="transactionManager">
      <chunk reader="itemReader" writer="itemWriter" commit-interval="10"/>
    </tasklet>
  </step>
</job>
```

The configuration above represents the only required dependencies to create a item-oriented step:

- `reader` - The `ItemReader` that provides items for processing.
- `writer` - The `ItemWriter` that processes the items provided by the `ItemReader`.
- `transaction-manager` - Spring's `PlatformTransactionManager` that will be used to begin and commit transactions during processing.
- `job-repository` - The `JobRepository` that will be used to periodically store the `StepExecution` and `ExecutionContext` during processing (just before committing). For an in-line `<step/>` (one defined within a `<job/>`) it is an attribute on the `<job/>` element; for a standalone step, it is defined as an attribute of the on the `<tasklet/>`.
- `commit-interval` - The number of items that will be processed before the transaction is committed.

It should be noted that, `job-repository` defaults to "jobRepository" and `transaction-manager` defaults to "transactionManger". Furthermore, the `ItemProcessor` is optional, not required, since the item could be directly passed from the reader to the writer.

5.1.2. Referencing a Standalone Step

While steps must exist within a `Job` to define the flow, it can sometimes be useful to reference a 'standalone' `Step`. For example, if a `Step` is used by multiple jobs it can be useful to declare it once and reference it from multiple jobs. This can be achieved with the 'parent' attribute:

```
<job id="sampleJob" job-repository="jobRepository">
  <step id="step1" parent="standaloneStep" />
</job>

<step id="standaloneStep">
  <tasklet job-repository="jobRepository" transaction-manager="transactionManager">
    <chunk reader="itemReader" writer="itemWriter" commit-interval="10"/>
  </tasklet>
</step>
```

It should be noted that the `id` attribute is still required on the step within the job element. This is for two reasons:

1. The `id` will be used as the step name when persisting the `StepExecution`. If the same standalone step is referenced in more than one step in the job, an error will occur.
2. When creating job flows, as described later in this chapter, the next attribute should be referring to the step in the flow, not the standalone step.

5.1.3. Inheriting from a Parent Step

If a group of `Steps` share similar configurations, then it may be helpful to define a "parent" `Step` from which the concrete `Steps` may inherit properties. Similar to class inheritance in Java, the "child" `Step` will combine its elements and attributes with the parent's. The child will also override any of the parent's `Steps`.

In the following example, the `Step` "concreteStep1" will inherit from "parentStep". It will be instantiated with 'itemReader', 'itemProcessor', 'itemWriter', `startLimit=5`, and `allowStartIfComplete=true`. Additionally, the `commitInterval` will be '5' since it is overridden by the "concreteStep1":

```
<step id="parentStep">
  <tasklet allow-start-if-complete="true">
    <chunk reader="itemReader" writer="itemWriter" commit-interval="10"/>
  </tasklet>
</step>

<step id="concreteStep1" parent="parentStep">
  <tasklet start-limit="5">
    <chunk processor="itemProcessor" commit-interval="5"/>
  </tasklet>
</step>
```

5.1.3.1. Abstract Step

Sometimes it may be necessary to define a parent `Step` that is not a complete `Step` configuration. If, for instance, the reader, writer, and tasklet attributes are left off of a `Step` configuration, then initialization will fail. If a parent must be defined without these properties, then the "abstract" attribute should be used. An "abstract" `Step` will not be instantiated; it is used only for extending.

In the following example, the `Step` "abstractParentStep" would not instantiate if it were not declared to be abstract. The `Step` "concreteStep2" will have 'itemReader', 'itemWriter', and `commitInterval=10`.

```
<step id="abstractParentStep" abstract="true">
  <tasklet>
    <chunk commit-interval="10"/>
  </tasklet>
</step>

<step id="concreteStep2" parent="abstractParentStep">
  <tasklet>
    <chunk reader="itemReader" writer="itemWriter"/>
  </tasklet>
</step>
```

5.1.3.2. Merging Lists

Some of the configurable elements on `Steps` are lists; the `<listeners/>` element, for instance. If both the parent and child `Steps` declare a `<listeners/>` element, then the child's list will override the parent's. In order to allow a child to add additional listeners to the list defined by the parent, every list element has a "merge" attribute. If the element specifies that `merge="true"`, then the child's list will be combined with the parent's instead of overriding it.

In the following example, the `Step` "concreteStep3" will be created will two listeners: `com.ListenerOne` and `com.ListenerTwo`:

```
<step id="listenersParentStep" abstract="true">
```



```

<listeners>
  <listener class="com.ListenerOne"/>
</listeners>
</step>

<step id="concreteStep3" parent="listenersParentStep">
  <tasklet>
    <chunk reader="itemReader" writer="itemWriter" commit-interval="5"/>
    <listeners merge="true">
      <listener class="com.ListenerTwo"/>
    </listeners>
  </tasklet>
</step>

```

5.1.4. The Commit Interval

As mentioned above, a step reads in and writes out items, periodically committing using the supplied `PlatformTransactionManager`. With a `commit-interval` of 1, it will commit after writing each individual item. This is less than ideal in many situations, since beginning and committing a transaction is expensive. Ideally, it is preferable to process as many items as possible in each transaction, which is completely dependent upon the type of data being processed and the resources with which the step is interacting. For this reason, the number of items that are processed within a commit can be configured.

```

<job id="sampleJob">
  <step id="step1">
    <tasklet>
      <chunk reader="itemReader" writer="itemWriter" commit-interval="10"/>
    </tasklet>
  </step>
</job>

```

In the example above, 10 items will be processed within each transaction. At the beginning of processing a transaction is begun, and each time `read` is called on the `ItemReader`, a counter is incremented. When it reaches 10, the list of aggregated items is passed to the `ItemWriter`, and the transaction will be committed.

5.1.5. Configuring a Step for Restart

In Chapter 4, *Configuring and Running a Job*, restarting a `Job` was discussed. Restart has numerous impacts on steps, and as such may require some specific configuration.

5.1.5.1. Setting a StartLimit

There are many scenarios where you may want to control the number of times a `Step` may be started. For example, a particular `Step` might need to be configured so that it only runs once because it invalidates some resource that must be fixed manually before it can be run again. This is configurable on the step level, since different steps may have different requirements. A `Step` that may only be executed once can exist as part of the same `Job` as a `Step` that can be run infinitely. Below is an example start limit configuration:

```

<step id="step1">
  <tasklet start-limit="1">
    <chunk reader="itemReader" writer="itemWriter" commit-interval="10"/>
  </tasklet>
</step>

```

The simple step above can be run only once. Attempting to run it again will cause an exception to be thrown. It should be noted that the default value for the `start-limit` is `Integer.MAX_VALUE`.

5.1.5.2. Restarting a completed step

In the case of a restartable job, there may be one or more steps that should always be run, regardless of whether or not they were successful the first time. An example might be a validation step, or a `Step` that cleans up resources before processing. During normal processing of a restarted job, any step with a status of 'COMPLETED', meaning it has already been completed successfully, will be skipped. Setting `allow-start-if-complete` to "true" overrides this so that the step will always run:

```
<step id="step1">
  <tasklet allow-start-if-complete="true">
    <chunk reader="itemReader" writer="itemWriter" commit-interval="10" />
  </tasklet>
</step>
```

5.1.5.3. Step Restart Configuration Example

```
<job id="footballJob" restartable="true">
  <step id="playerload" next="gameLoad">
    <tasklet>
      <chunk reader="playerFileItemReader" writer="playerWriter"
        commit-interval="10" />
    </tasklet>
  </step>
  <step id="gameLoad" next="playerSummarization">
    <tasklet allow-start-if-complete="true">
      <chunk reader="gameFileItemReader" writer="gameWriter"
        commit-interval="10" />
    </tasklet>
  </step>
  <step id="playerSummarization">
    <tasklet start-limit="3">
      <chunk reader="playerSummarizationSource" writer="summaryWriter"
        commit-interval="10" />
    </tasklet>
  </step>
</job>
```

The above example configuration is for a job that loads in information about football games and summarizes them. It contains three steps: `playerLoad`, `gameLoad`, and `playerSummarization`. The `playerLoad` `Step` loads player information from a flat file, while the `gameLoad` `Step` does the same for games. The final `Step`, `playerSummarization`, then summarizes the statistics for each player based upon the provided games. It is assumed that the file loaded by 'playerLoad' must be loaded only once, but that 'gameLoad' will load any games found within a particular directory, deleting them after they have been successfully loaded into the database. As a result, the `playerLoad` `Step` contains no additional configuration. It can be started almost limitlessly, and if complete will be skipped. The 'gameLoad' `Step`, however, needs to be run every time in case extra files have been dropped since it last executed. It has 'allow-start-if-complete' set to 'true' in order to always be started. (It is assumed that the database tables games are loaded into has a process indicator on it, to ensure new games can be properly found by the summarization step). The summarization `Step`, which is the most important in the `Job`, is configured to have a start limit of 3. This is useful because if the step continually fails, a new exit code will be returned to the operators that control job execution, and it won't be allowed to start again until manual intervention has taken place.



Note

This job is purely for example purposes and is not the same as the `footballJob` found in the samples project.

Run 1:

1. `playerLoad` is executed and completes successfully, adding 400 players to the 'PLAYERS' table.
2. `gameLoad` is executed and processes 11 files worth of game data, loading their contents into the 'GAMES' table.
3. `playerSummarization` begins processing and fails after 5 minutes.

Run 2:

1. `playerLoad` is not run, since it has already completed successfully, and `allow-start-if-complete` is 'false' (the default).
2. `gameLoad` is executed again and processes another 2 files, loading their contents into the 'GAMES' table as well (with a process indicator indicating they have yet to be processed)
3. `playerSummarization` begins processing of all remaining game data (filtering using the process indicator) and fails again after 30 minutes.

Run 3:

1. `playerLoad` is not run, since it has already completed successfully, and `allow-start-if-complete` is 'false' (the default).
2. `gameLoad` is executed again and processes another 2 files, loading their contents into the 'GAMES' table as well (with a process indicator indicating they have yet to be processed)
3. `playerSummarization` is not start, and the job is immediately killed, since this is the third execution of `playerSummarization`, and its limit is only 2. The limit must either be raised, or the `Job` must be executed as a new `JobInstance`.

5.1.6. Configuring Skip Logic

There are many scenarios where errors encountered while processing should not result in `Step` failure, but should be skipped instead. This is usually a decision that must be made by someone who understands the data itself and what meaning it has. Financial data, for example, may not be skippable because it results in money being transferred, which needs to be completely accurate. Loading a list of vendors, on the other hand, might allow for skips. If a vendor is not loaded because it was formatted incorrectly or was missing necessary information, then there probably won't be issues. Usually these bad records are logged as well, which will be covered later when discussing listeners.

```
<step id="step1">
  <tasklet>
    <chunk reader="flatFileItemReader" writer="itemWriter"
      commit-interval="10" skip-limit="10">
      <skippable-exception-classes>
        org.springframework.batch.item.file.FlatFileParseException
      </skippable-exception-classes>
    </chunk>
  </tasklet>
</step>
```

In this example, a `FlatFileItemReader` is used, and if at any point a `FlatFileParseException` is thrown, it will be skipped and counted against the total skip limit of 10. Separate counts are made of skips on read, process and write inside the step execution, and the limit applies across all.

5.1.7. Configuring Fatal Exceptions

One problem with the example above is that any other exception besides a `FlatFileParseException` will cause the `Job` to fail. In certain scenarios this may be the correct behavior. However, in other scenarios it may be easier to identify which exceptions should cause failure and skip everything else:

```
<step id="step1">
  <tasklet>
    <chunk reader="flatFileItemReader" writer="itemWriter"
      commit-interval="10" skip-limit="10">
      <skippable-exception-classes>
        java.lang.Exception
      </skippable-exception-classes>
      <fatal-exception-classes>
        java.io.FileNotFoundException
      </fatal-exception-classes>
    </chunk>
  </tasklet>
</step>
```

By setting the skippable exceptions to `java.lang.Exception`, any exception that is thrown will be skipped. However, the second list, 'fatal-exception-classes', contains specific exceptions that should be fatal if encountered (i.e. not skipped).

5.1.8. Configuring Retry Logic

In most cases you want an exception to cause either a skip or `Step` failure. However, not all exceptions are deterministic. If a `FlatFileParseException` is encountered while reading, it will always be thrown for that record; resetting the `ItemReader` will not help. However, for other exceptions, such as a `DeadlockLoserDataAccessException`, which indicates that the current process has attempted to update a record that another process holds a lock on, waiting and trying again might result in success. In this case, retry should be configured:

```
<step id="step1">
  <tasklet>
    <chunk reader="itemReader" writer="itemWriter"
      commit-interval="2" retry-limit="3">
      <retryable-exception-classes>
        org.springframework.dao.DeadlockLoserDataAccessException
      </retryable-exception-classes>
    </chunk>
  </tasklet>
</step>
```

The `Step` allows a limit for the number of times an individual item can be retried, and a list of exceptions that are 'retryable'. More details on how retry works can be found in Chapter 9, *Retry*

5.1.9. Controlling Rollback

By default, regardless of retry or skip, any exceptions thrown from the `ItemWriter` will cause the transaction controlled by the `Step` to rollback. If skip is configured as described above, exceptions thrown from the `ItemReader` will not cause a rollback. However, there are many scenarios in which exceptions thrown from the `ItemWriter` should not cause a rollback because no action has taken place to invalidate the transaction. For this reason, the `Step` can be configured with a list of exceptions that should not cause rollback. The `no-rollback-exception-classes` element is a list of transaction attributes, separated by commas or newlines.

```

<step id="step1">
  <tasklet>
    <chunk reader="itemReader" writer="itemWriter" commit-interval="2"/>
    <no-rollback-exception-classes>
      org.springframework.batch.item.validator.ValidationException
    </no-rollback-exception-classes>
  </tasklet>
</step>

```

5.1.9.1. Transactional Readers

The basic contract of the `ItemReader` is that it is forward only. The step buffers reader input, so that in the case of a rollback the items don't need to be re-read from the reader. However, there are certain scenarios in which the reader is built on top of a transactional resource, such as a JMS queue. In this case, since the queue is tied to the transaction that is rolled back, the messages that have been pulled from the queue will be put back on. For this reason, the step can be configured to not buffer the items:

```

<step id="step1">
  <tasklet>
    <chunk reader="itemReader" writer="itemWriter" commit-interval="2"
      is-reader-transactional-queue="true"/>
  </tasklet>
</step>

```

5.1.10. Transaction Attributes

Transaction attributes can be used to control the isolation, propagation, and timeout settings. More information on setting transaction attributes can be found in the spring core documentation.

```

<step id="step1">
  <tasklet>
    <chunk reader="itemReader" writer="itemWriter" commit-interval="2"/>
    <transaction-attributes isolation="DEFAULT"
      propagation="REQUIRED"
      timeout="30"/>
  </tasklet>
</step>

```

5.1.11. Registering ItemStreams with the Step

The step has to take care of `ItemStream` callbacks at the necessary points in its lifecycle. (for more information on the `ItemStream` interface, please refer to Section 6.4, “ItemStream”) This is vital if a step fails, and might need to be restarted, because the `ItemStream` interface is where the step gets the information it needs about persistent state between executions.

If the `ItemReader`, `ItemProcessor`, or `ItemWriter` itself implements the `ItemStream` interface, then these will be registered automatically. Any other streams need to be registered separately. This is often the case where there are indirect dependencies such as delegates being injected into the reader and writer. A stream can be registered on the `Step` through the 'streams' element, as illustrated below:

```

<step id="step1">
  <tasklet>
    <chunk reader="itemReader" writer="compositeWriter" commit-interval="2">
      <streams>
        <stream ref="fileItemWriter1"/>
        <stream ref="fileItemWriter2"/>
      </streams>
    </chunk>
  </tasklet>
</step>

```

```

</tasklet>
</step>

<beans:bean id="compositeWriter"
            class="org.springframework.batch.item.support.CompositeItemWriter">
  <beans:property name="delegates">
    <beans:list>
      <beans:ref bean="fileItemWriter1" />
      <beans:ref bean="fileItemWriter2" />
    </beans:list>
  </beans:property>
</beans:bean>

```

In the example above, the `CompositeItemWriter` is not an `ItemStream`, but both of its delegates are. Therefore, both delegate writers must be explicitly registered as streams in order for the framework to handle them correctly. The `ItemReader` does not need to be explicitly registered as a stream because it is a direct property of the `Step`. The step will now be restartable and the state of the reader and writer will be correctly persisted in the event of a failure.

5.1.12. Intercepting Step Execution

Just as with the `Job`, there are many events during the execution of a `Step` where a user may need to perform some functionality. For example, in order to write out to a flat file that requires a footer, the `ItemWriter` needs to be notified when the `Step` has been completed, so that the footer can be written. This can be accomplished with one of many `Step` scoped listeners.

Any class that implements the `StepListener` interface (or an extension thereof) can be applied to a step via the `listeners` element:

```

<step id="step1">
  <tasklet>
    <chunk reader="reader" writer="writer" commit-interval="10"/>
    <listeners>
      <listener ref="stepListener"/>
    </listeners>
  </tasklet>
</step>

```

An `ItemReader`, `ItemWriter` or `ItemProcessor` that itself implements one of the `StepListener` interfaces will be registered automatically with the `Step` if using the namespace `<step>` element, or one of the `*StepFactoryBean` factories. This only applies to components directly injected into the `Step`: if the listener is nested inside another component, it needs to be explicitly registered (as described above).

In addition to the `StepListener` interfaces, annotations are provided to address the same concerns.

5.1.12.1. StepExecutionListener

`StepExecutionListener` represents the most generic listener for `Step` execution. It allows for notification before a `Step` is started and after it has ended, whether it ended normally or failed:

```

public interface StepExecutionListener extends StepListener {

    void beforeStep(StepExecution stepExecution);

    ExitStatus afterStep(StepExecution stepExecution);

}

```

`ExitStatus` is the return type of `afterStep` in order to allow listeners the chance to modify the exit code that is returned upon completion of a `Step`.

The annotations corresponding to this interface are:

- `@BeforeStep`
- `@AfterStep`

5.1.12.2. ChunkListener

A chunk is defined as the items processed within the scope of a transaction. Committing a transaction, at each commit interval, commits a 'chunk'. A `ChunkListener` may be useful to perform logic before a chunk begins processing or after a chunk has completed:

```
public interface ChunkListener extends StepListener {  
  
    void beforeChunk();  
  
    void afterChunk();  
  
}
```

The `beforeChunk` method is called after the transaction is started, but before `read` is called on the `ItemReader`. Conversely, `afterChunk` is called after the last call to `write` on the `ItemWriter`, but before the chunk has been committed.

The annotations corresponding to this interface are:

- `@BeforeChunk`
- `@AfterChunk`

5.1.12.3. ItemReadListener

When discussing skip logic above, it was mentioned that it may be beneficial to log out skipped records, so that they can be dealt with later. In the case of read errors, this can be done with an `ItemReaderListener`:

```
public interface ItemReadListener<T> extends StepListener {  
  
    void beforeRead();  
  
    void afterRead(T item);  
  
    void onReadError(Exception ex);  
  
}
```

The `beforeRead` method will be called before each call to `read` on the `ItemReader`. The `afterRead` method will be called after each successful call to `read`, and will be passed the item that was read. If there was an error while reading, the `onReadError` method will be called. The exception encountered will be provided so that it can be logged.

The annotations corresponding to this interface are:

- `@BeforeRead`

- @AfterRead
- @OnReadError

5.1.12.4. ItemProcessListener

Just as with the `ItemReadListener`, the processing of an item can be 'listened' to:

```
public interface ItemProcessListener<T, S> extends StepListener {  
  
    void beforeProcess(T item);  
  
    void afterProcess(T item, S result);  
  
    void onProcessError(T item, Exception e);  
  
}
```

The `beforeProcess` method will be called before `process` on the `ItemProcessor`, and is handed the item that will be processed. The `afterProcess` method will be called after the item has been successfully processed. If there was an error while processing, the `onProcessError` method will be called. The exception encountered and the item that was attempted to be processed will be provided, so that they can be logged.

The annotations corresponding to this interface are:

- @BeforeProcess
- @AfterProcess
- @OnProcessError

5.1.12.5. ItemWriteListener

The writing of an item can be 'listened' to with the `ItemWriteListener`:

```
public interface ItemWriteListener<S> extends StepListener {  
  
    void beforeWrite(List<? extends S> items);  
  
    void afterWrite(List<? extends S> items);  
  
    void onWriteError(Exception exception, List<? extends S> items);  
  
}
```

The `beforeWrite` method will be called before `write` on the `ItemWriter`, and is handed the item that will be written. The `afterWrite` method will be called after the item has been successfully written. If there was an error while writing, the `onWriteError` method will be called. The exception encountered and the item that was attempted to be written will be provided, so that they can be logged.

The annotations corresponding to this interface are:

- @BeforeWrite
- @AfterWrite
- @OnWriteError

5.1.12.6. SkipListener

`ItemReadListener`, `ItemProcessListener`, and `ItemWriteListener` all provide mechanisms for being notified of errors, but none will inform you that a record has actually been skipped. `onWriteError`, for example, will be called even if an item is retried and successful. For this reason, there is a separate interface for tracking skipped items:

```
public interface SkipListener<T,S> extends StepListener {

    void onSkipInRead(Throwable t);

    void onSkipInProcess(T item, Throwable t);

    void onSkipInWrite(S item, Throwable t);

}
```

`onSkipInRead` will be called whenever an item is skipped while reading. It should be noted that rollbacks may cause the same item to be registered as skipped more than once. `onSkipInWrite` will be called when an item is skipped while writing. Because the item has been read successfully (and not skipped), it is also provided the item itself as an argument.

The annotations corresponding to this interface are:

- `@OnSkipInRead`
- `@OnSkipInWrite`
- `@OnSkipInProcess`

5.1.12.6.1. SkipListeners and Transactions

One of the most common use cases for a `SkipListener` is to log out a skipped item, so that another batch process or even human process can be used to evaluate and fix the issue leading to the skip. Because there are many cases in which the original transaction may be rolled back, Spring Batch makes two guarantees:

1. The appropriate skip method (depending on when the error happened) will only be called once per item.
2. The `SkipListener` will always be called just before the transaction is committed. This is to ensure that any transactional resources call by the listener are not rolled back by a failure within the `ItemWriter`.

5.2. TaskletStep

Chunk-oriented processing is not the only way to process in a `Step`. What if a `Step` must consist as a simple stored procedure call? You could implement the call as an `ItemReader` and return null after the procedure finishes, but it is a bit unnatural since there would need to be a no-op `ItemWriter`. Spring Batch provides the `TaskletStep` for this scenario.

The `Tasklet` is a simple interface that has one method, `execute`, which will be called repeatedly by the `TaskletStep` until it either returns `RepeatStatus.FINISHED` or throws an exception to signal a

failure. Each call to the `Tasklet` is wrapped in a transaction. `Tasklet` implementors might call a stored procedure, a script, or a simple SQL update statement. To create a `TaskletStep`, the 'ref' attribute of the `<tasklet/>` element should reference a bean defining a `Tasklet` object; no `<chunk/>` element should be used within the `<tasklet/>`:

```
<step id="step1">
  <tasklet ref="myTasklet"/>
</step>
```



Note

`TaskletStep` will automatically register the tasklet as `StepListener` if it implements this interface

5.2.1. TaskletAdapter

As with other adapters for the `ItemReader` and `ItemWriter` interfaces, the `Tasklet` interface contains an implementation that allows for adapting itself to any pre-existing class: `TaskletAdapter`. An example where this may be useful is an existing DAO that is used to update a flag on a set of records. The `TaskletAdapter` can be used to call this class without having to write an adapter for the `Tasklet` interface:

```
<bean id="myTasklet" class="org.springframework.batch.core.step.tasklet.TaskletAdapter">
  <property name="targetObject">
    <bean class="org.mycompany.FooDao">
  </property>
  <property name="targetMethod" value="updateFoo" />
</bean>
```

5.2.2. Example Tasklet Implementation

Many batch jobs contain steps that must be done before the main processing begins in order to set up various resources or after processing has completed to cleanup those resources. In the case of a job that works heavily with files, it is often necessary to delete certain files locally after they have been uploaded successfully to another location. The example below taken from the Spring Batch samples project, is a `Tasklet` implementation with just such a responsibility:

```
public class FileDeletingTasklet implements Tasklet, InitializingBean {

    private Resource directory;

    public RepeatStatus execute(StepContribution contribution,
                               ChunkContext chunkContext) throws Exception {
        File dir = directory.getFile();
        Assert.state(dir.isDirectory());

        File[] files = dir.listFiles();
        for (int i = 0; i < files.length; i++) {
            boolean deleted = files[i].delete();
            if (!deleted) {
                throw new UnexpectedJobExecutionException("Could not delete file " +
                                                            files[i].getPath());
            }
        }
        return RepeatStatus.COMPLETED;
    }

    public void setDirectoryResource(Resource directory) {
```

```

    this.directory = directory;
}

public void afterPropertiesSet() throws Exception {
    Assert.notNull(directory, "directory must be set");
}
}

```

The above `Tasklet` implementation will delete all files within a given directory. It should be noted that the `execute` method will only be called once. All that is left is to reference the `Tasklet` from the `Step`:

```

<job id="taskletJob">
  <step id="deleteFilesInDir">
    <tasklet ref="fileDeletingTasklet"/>
  </step>
</job>

<beans:bean id="fileDeletingTasklet"
  class="org.springframework.batch.sample.tasklet.FileDeletingTasklet">
  <beans:property name="directoryResource">
    <beans:bean id="directory"
      class="org.springframework.core.io.FileSystemResource">
      <beans:constructor-arg value="target/test-outputs/test-dir" />
    </beans:bean>
  </beans:property>
</beans:bean>

```

5.3. Controlling Step Flow

With the ability to group steps together within an owning job comes the need to be able to control how the job 'flows' from one step to another. The failure of a `Step` doesn't necessarily mean that the `Job` should fail. Furthermore, there may be more than one type of 'success' which determines which `Step` should be executed next. Depending upon how a group of `Steps` is configured, certain steps may not even be processed at all.

5.3.1. Sequential Flow

The simplest flow scenario is a job where all of the steps execute sequentially:

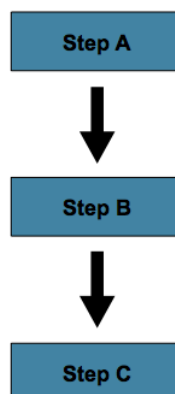

This can be achieved using the 'next' attribute of the step element:

```

<job id="job">
  <step id="stepA" parent="s1" next="stepB" />
  <step id="stepB" parent="s2" next="stepC" />
  <step id="stepC" parent="s3" />
</job>

```

In the scenario above, 'step A' will execute first because it is the first `step` listed. If 'step A' completes normally, then 'step B' will execute, and so on. However, if 'step A' fails, then the entire `job` will fail and 'step B' will not execute.



Note

With the Spring Batch namespace, the first step listed in the configuration will *always* be the first step executed by the `job`. The order of the other step elements does not matter, but the first step must always appear first in the xml.

5.3.2. Conditional Flow

In the example above, there are only two possibilities:

1. The `step` is successful and the next `step` should be executed.
2. The `step` failed and thus the `job` should fail.

In many cases, this may be sufficient. However, what about a scenario in which the failure of a `step` should trigger a different `step`, rather than causing failure?

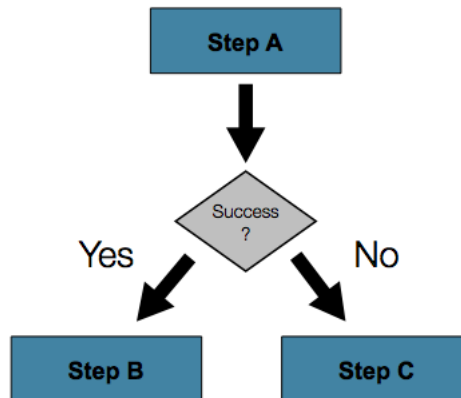

In order to handle more complex scenarios, the Spring Batch namespace allows transition elements to be defined within the step element. One such transition is the "next" element. Like the "next" attribute, the "next" element will tell the `job` which `step` to execute next. However, unlike the attribute, any number of "next" elements are allowed on a given `step`, and there is no default behavior the case of failure. This means that if transition elements are used, then all of the behavior for the `step`'s transitions must be defined explicitly. Note also that a single step cannot have both a "next" attribute and a transition element.

The next element specifies a pattern to match and the step to execute next:

```

<job id="job">
  <step id="stepA" parent="s1">
    <next on="*" to="stepB" />
    <next on="FAILED" to="stepC" />
  </step>
  <step id="stepB" parent="s2" next="stepC" />
  <step id="stepC" parent="s3" />
</job>

```

The "on" attribute of a transition element uses a simple pattern-matching scheme to match the `ExitStatus` that results from the execution of the `step`. Only two special characters are allowed in the pattern:

- "*" will zero or more characters
- "?" will match exactly one character

For example, "c*t" will match "cat" and "count", while "c?t" will match "cat" but not "count".

While there is no limit to the number of transition elements on a `Step`, if the `Step`'s execution results in an `ExitStatus` that is not covered by an element, then the framework will throw an exception and the `Job` will fail. It is important to note that the framework will automatically order transitions from most specific to least specific. This means that even if the elements were swapped for "stepA" in the example above, an `ExitStatus` of "FAILED" would still go to "stepB".

5.3.2.1. Batch Status vs. Exit Status

When configuring a `Job` for conditional flow, it is important to understand the difference between `BatchStatus` and `ExitStatus`. `BatchStatus` is an enumeration that is a property of both `JobExecution` and `StepExecution` and is used by the framework to record the status of a `Job` or `Step`. It can be one of the following values: `COMPLETED`, `STARTING`, `STARTED`, `STOPPING`, `STOPPED`, `FAILED`, `ABANDONED` or `UNKNOWN`. Most of them are self explanatory: `COMPLETED` is the status set when a step or job has completed successfully, `FAILED` is set when it fails, and so on. The example above contains the following 'next' element:

```
<next on="FAILED" to="stepB" />
```

At first glance, it would appear that the 'on' attribute references the `BatchStatus` of the `Step` to which it belongs. However, it actually references the `ExitStatus` of the `Step`. As the name implies, `ExitStatus` represents the status of a `Step` after it finishes execution. More specifically, the 'next' element above references the exit code of the `ExitStatus`. To write it in English, it says: "go to stepB if the exit code is FAILED". By default, the exit code is always the same as the `BatchStatus` for the `Step`, which is why the entry above works. However, what if the exit code needs to be different? A good example comes from the skip sample job within the samples project:

```
<step id="step1" parent="s1">
  <end on="FAILED" />
  <next on="COMPLETED WITH SKIPS" to="errorPrint1" />
  <next on="*" to="step2" />
</step>
```

The above step has three possibilities:

1. The `Step` failed, in which case the job should fail.
2. The `Step` completed successfully.
3. The `Step` completed successfully, but with an exit code of 'COMPLETED WITH SKIPS'. In this case, a different step should be run to handle the errors.

The above configuration will work. However, something needs to change the exit code based on the condition of the execution having skipped records:

```
public class SkipCheckingListener extends StepExecutionListenerSupport {

    public ExitStatus afterStep(StepExecution stepExecution) {
        String exitCode = stepExecution.getExitStatus().getExitCode();
        if (!exitCode.equals(ExitStatus.FAILED.getExitCode()) &&
```

```

        stepExecution.getSkipCount() > 0) {
            return new ExitStatus("COMPLETED WITH SKIPS");
        }
        else {
            return null;
        }
    }
}

```

The above code is a `StepExecutionListener` that first checks to make sure the `Step` was successful, and next if the skip count on the `StepExecution` is higher than 0. If both conditions are met, a new `ExitStatus` with an exit code of "COMPLETED WITH SKIPS" is returned.

5.3.3. Configuring for Stop

After the discussion of `BatchStatus` and `ExitStatus`, one might wonder how the `BatchStatus` and `ExitStatus` are determined for the `Job`. While these statuses are determined for the `Step` by the code that is executed, the statuses for the `Job` will be determined based on the configuration.

So far, all of the job configurations discussed have had at least one final `Step` with no transitions. For example, after the following step executes, the `Job` will end:

```
<step id="stepC" parent="s3"/>
```

If no transitions are defined for a `Step`, then the `Job`'s statuses will be defined as follows:

- If the `Step` ends with `ExitStatus FAILED`, then the `Job`'s `BatchStatus` and `ExitStatus` will both be `FAILED`.
- Otherwise, the `Job`'s `BatchStatus` and `ExitStatus` will both be `COMPLETED`.

While this method of terminating a batch job is sufficient for some batch jobs, such as a simple sequential step job, custom defined job-stopping scenarios may be required. For this purpose, Spring Batch provides three transition elements to stop a `Job` (in addition to the "next" element [47] that we discussed previously). Each of these stopping elements will stop a `Job` with a particular `BatchStatus`. It is important to note that the stop transition elements will have no effect on either the `BatchStatus` or `ExitStatus` of any `Steps` in the `Job`: these elements will only affect the final statuses of the `Job`. For example, it is possible for every step in a job to have a status of `FAILED` but the job to have a status of `COMPLETED`, or vice versa.

5.3.3.1. The 'End' Element

The 'end' element instructs a `Job` to stop with a `BatchStatus` of `COMPLETED`. A `Job` that has finished with status `COMPLETED` cannot be restarted (the framework will throw a `JobInstanceAlreadyCompleteException`). The 'end' element also allows for an optional 'exit-code' attribute that can be used to customize the `ExitStatus` of the `Job`. If no 'exit-code' attribute is given, then the `ExitStatus` will be "COMPLETED" by default, to match the `BatchStatus`.

In the following scenario, if `step2` fails, then the `Job` will stop with a `BatchStatus` of `COMPLETED` and an `ExitStatus` of "COMPLETED" and `step3` will not execute; otherwise, execution will move to `step3`. Note that if `step2` fails, the `Job` will not be restartable (because the status is `COMPLETED`).

```
<step id="step1" parent="s1" next="step2">
```

```

<step id="step2" parent="s2">
  <end on="FAILED"/>
  <next on="*" to="step3"/>
</step>

<step id="step3" parent="s3">

```

5.3.3.2. The 'Fail' Element

The 'fail' element instructs a `Job` to stop with a `BatchStatus` of `FAILED`. Unlike the 'end' element, the 'fail' element will not prevent the `Job` from being restarted. The 'fail' element also allows for an optional 'exit-code' attribute that can be used to customize the `ExitStatus` of the `Job`. If no 'exit-code' attribute is given, then the `ExitStatus` will be "FAILED" by default, to match the `BatchStatus`.

In the following scenario, if `step2` fails, then the `Job` will stop with a `BatchStatus` of `FAILED` and an `ExitStatus` of "EARLY TERMINATION" and `step3` will not execute; otherwise, execution will move to `step3`. Additionally, if `step2` fails, and the `Job` is restarted, then execution will begin again on `step2`.

```

<step id="step1" parent="s1" next="step2">

<step id="step2" parent="s2">
  <fail on="FAILED" exit-code="EARLY TERMINATION"/>
  <next on="*" to="step3"/>
</step>

<step id="step3" parent="s3">

```

5.3.3.3. The 'Stop' Element

The 'stop' element instructs a `Job` to stop with a `BatchStatus` of `STOPPED`. Stopping a `Job` can provide a temporary break in processing so that the operator can take some action before restarting the `Job`. The 'stop' element requires a 'restart' attribute that specifies the step where execution should pick up when the `Job` is restarted.

In the following scenario, if `step1` finishes with `COMPLETE`, then the job will then stop. Once it is restarted, execution will begin on `step2`.

```

<step id="step1" parent="s1">
  <stop on="COMPLETED" restart="step2"/>
</step>

<step id="step2" parent="s2"/>

```

5.3.4. Programmatic Flow Decisions

In some situations, more information than the `ExitStatus` may be required to decide which step to execute next. In this case, a `JobExecutionDecider` can be used to assist in the decision.

```

public class MyDecider implements JobExecutionDecider {
    public String decide(JobExecution jobExecution, StepExecution stepExecution) {
        if (someCondition) {
            return "FAILED";
        }
        else {
            return "COMPLETED";
        }
    }
}

```

In the job configuration, a "decision" tag will specify the decider to use as well as all of the transitions.

```
<job id="job">
  <step id="step1" parent="s1" next="decision" />

  <decision id="decision" decider="decider">
    <next on="FAILED" to="step2" />
    <next on="COMPLETED" to="step3" />
  </decision>

  <step id="step2" parent="s2" next="step3"/>
  <step id="step3" parent="s3" />
</job>

<beans:bean id="decider" class="com.MyDecider"/>
```

5.3.5. Split Flows

Every scenario described so far has involved a `Job` that executes its `Steps` one at a time in a linear fashion. In addition to this typical style, the Spring Batch namespace also allows for a job to be configured with parallel flows using the 'split' element. As is seen below, the 'split' element contains one or more 'flow' elements, where entire separate flows can be defined. A 'split' element may also contain any of the previously discussed transition elements such as the 'next' attribute or the 'next', 'end', 'fail', or 'pause' elements.

```
<split id="split1" next="step4">
  <flow>
    <step id="step1" parent="s1" next="step2" />
    <step id="step2" parent="s2" />
  </flow>
  <flow>
    <step id="step3" parent="s3" />
  </flow>
</split>
<step id="step4" parent="s4" />
```

5.4. Late Binding of Job and Step Attributes

Both the XML and Flat File examples above use the Spring `Resource` abstraction to obtain a file. This works because `Resource` has a `getFile` method, which returns a `java.io.File`. Both XML and Flat File resources can be configured using standard Spring constructs:

```
<bean id="flatFileItemReader"
  class="org.springframework.batch.item.file.FlatFileItemReader">
  <property name="resource"
    value="file://outputs/20070122.testStream.CustomerReportStep.TEMP.txt" />
</bean>
```

The above `Resource` will load the file from the file system location specified. Note that absolute locations have to start with a double slash ("//"). In most spring applications, this solution is good enough because the names of these are known at compile time. However, in batch scenarios, the file name may need to be determined at runtime as a parameter to the job. This could be solved using '-D' parameters, i.e. a system property:

```
<bean id="flatFileItemReader"
  class="org.springframework.batch.item.file.FlatFileItemReader">
  <property name="resource" value="\${input.file.name}" />
</bean>
```

All that would be required for this solution to work would be a system argument (-Dinput.file.name="file://file.txt"). (Note that although a `PropertyPlaceholderConfigurer` can be used here, it is not necessary if the system property is always set because the `ResourceEditor` in Spring already filters and does placeholder replacement on system properties.)

Often in a batch setting it is preferable to parameterize the file name in the `JobParameters` of the job, instead of through system properties, and access them that way. To accomplish this, Spring Batch allows for the late binding of various Job and Step attributes:

```
<bean id="flatFileItemReader" scope="step"
      class="org.springframework.batch.item.file.FlatFileItemReader">
  <property name="resource" value="#{jobParameters[input.file.name]}" />
</bean>
```

Both the `JobExecution` and `StepExecution` level `ExecutionContext` can be accessed in the same way:

```
<bean id="flatFileItemReader" scope="step"
      class="org.springframework.batch.item.file.FlatFileItemReader">
  <property name="resource" value="#{jobExecutionContext[input.file.name]}" />
</bean>
```

```
<bean id="flatFileItemReader" scope="step"
      class="org.springframework.batch.item.file.FlatFileItemReader">
  <property name="resource" value="#{stepExecutionContext[input.file.name]}" />
</bean>
```



Note

Any bean that uses late-binding must be declared with `scope="step"`. See for Section 5.4.1, “Step Scope” more information.

5.4.1. Step Scope

All of the late binding examples from above have a scope of "step" declared on the bean definition:

```
<bean id="flatFileItemReader" scope="step"
      class="org.springframework.batch.item.file.FlatFileItemReader">
  <property name="resource" value="#{jobParameters[input.file.name]}" />
</bean>
```

Using a scope of `Step` is required in order to use late binding since the bean cannot actually be instantiated until the `Step` starts, which allows the attributes to be found. Because it is not part of the Spring container by default, it must be added explicitly, either by using the `batch` namespace:

```
<beans:beans xmlns="http://www.springframework.org/schema/beans"
             xmlns:batch="http://www.springframework.org/schema/batch"
             xmlns:xsi="http://www.w3.org/2001/XMLSchema-instance"
             xsi:schemaLocation="...">
  ...
</beans:beans>
```

or by including a bean definition explicitly for the `Step` (but not both):

```
<bean class="org.springframework.batch.core.scope.StepScope" />
```

Chapter 6. ItemReaders and ItemWriters

All batch processing can be described in its most simple form as reading in large amounts of data, performing some type of calculation or transformation, and writing the result out. Spring Batch provides three key interfaces to help perform bulk reading and writing: `ItemReader`, `ItemProcessor` and `ItemWriter`.

6.1. ItemReader

Although a simple concept, an `ItemReader` is the means for providing data from many different types of input. The most general examples include:

- Flat File- Flat File Item Readers read lines of data from a flat file that typically describe records with fields of data defined by fixed positions in the file or delimited by some special character (e.g. Comma).
- XML - XML ItemReaders process XML independently of technologies used for parsing, mapping and validating objects. Input data allows for the validation of an XML file against an XSD schema.
- Database - A database resource is accessed to return resultsets which can be mapped to objects for processing. The default SQL ItemReaders invoke a `RowMapper` to return objects, keep track of the current row if restart is required, store basic statistics, and provide some transaction enhancements that will be explained later.

There are many more possibilities, but we'll focus on the basic ones for this chapter. A complete list of all available `ItemReaders` can be found in Appendix A.

`ItemReader` is a basic interface for generic input operations:

```
public interface ItemReader<T> {  
  
    T read() throws Exception, UnexpectedInputException, ParseException;  
  
}
```

The `read` method defines the most essential contract of the `ItemReader`; calling it returns one `Item` or null if no more items are left. An item might represent a line in a file, a row in a database, or an element in an XML file. It is generally expected that these will be mapped to a usable domain object (i.e. `Trade`, `Foo`, etc) but there is no requirement in the contract to do so.

It is expected that implementations of the `ItemReader` interface will be forward only. However, if the underlying resource is transactional (such as a JMS queue) then calling `read` may return the same logical item on subsequent calls in a rollback scenario. It is also worth noting that a lack of items to process by an `ItemReader` will not cause an exception to be thrown. For example, a database `ItemReader` that is configured with a query that returns 0 results will simply return null on the first invocation of `read`.

6.2. ItemWriter

`ItemWriter` is similar in functionality to an `ItemReader`, but with inverse operations. Resources still need to be located, opened and closed but they differ in that an `ItemWriter` writes out, rather than reading in. In the case of databases or queues these may be inserts, updates, or sends. The format of the serialization of the output is specific to each batch job.

As with `ItemReader`, `ItemWriter` is a fairly generic interface:

```
public interface ItemWriter<T> {

    void write(List<? extends T> items) throws Exception;

}
```

As with `read` on `ItemReader`, `write` provides the basic contract of `ItemWriter`; it will attempt to write out the list of items passed in as long as it is open. Because it is generally expected that items will be 'batched' together into a chunk and then output, the interface accepts a list of items, rather than an item by itself. After writing out the list, any flushing that may be necessary can be performed before returning from the `write` method. For example, if writing to a Hibernate DAO, multiple calls to `write` can be made, one for each item. The writer can then call `close` on the hibernate `Session` before returning.

6.3. ItemProcessor

The `ItemReader` and `ItemWriter` interfaces are both very useful for their specific tasks, but what if you want to insert business logic before writing? One option for both reading and writing is to use the composite pattern: create an `ItemWriter` that contains another `ItemWriter`, or an `ItemReader` that contains another `ItemReader`. For example:

```
public class CompositeItemWriter<T> implements ItemWriter<T> {

    ItemWriter<T> itemWriter;

    public CompositeItemWriter(ItemWriter<T> itemWriter) {
        this.itemWriter = itemWriter;
    }

    public void write(List<? extends T> items) throws Exception {
        //Add business logic here
        itemWriter.write(item);
    }

    public void setDelegate(ItemWriter<T> itemWriter){
        this.itemWriter = itemWriter;
    }

}
```

The class above contains another `ItemWriter` to which it delegates after having provided some business logic. This pattern could easily be used for an `ItemReader` as well, perhaps to obtain more reference data based upon the input that was provided by the main `ItemReader`. It is also useful if you need to control the call to `write` yourself. However, if you only want to 'transform' the item passed in for writing before it is actually written, there isn't much need to call `write` yourself: you just want to modify the item. For this scenario, Spring Batch provides the `ItemProcessor` interface:

```
public interface ItemProcessor<I, O> {

    O process(I item) throws Exception;

}
```

An `ItemProcessor` is very simple; given one object, transform it and return another. The provided object may or may not be of the same type. The point is that business logic may be applied within process, and is completely up to the developer to create. An `ItemProcessor` can be wired directly into a step. For example, assuming an `ItemReader` provides a class of type `Foo`, and it needs to be converted to type `Bar` before being written out. An `ItemProcessor` can be written that performs the conversion:

```
public class Foo {}
```

```

public class Bar {
    public Bar(Foo foo) {}
}

public class FooProcessor implements ItemProcessor<Foo,Bar>{
    public Bar process(Foo foo) throws Exception {
        //Perform simple transformation, convert a Foo to a Bar
        return new Bar(foo);
    }
}

public class BarWriter implements ItemWriter<Bar>{
    public void write(List<? extends Bar> bars) throws Exception {
        //write bars
    }
}

```

In the very simple example above, there is a class `Foo`, a class `Bar`, and a class `FooProcessor` that adheres to the `ItemProcessor` interface. The transformation is simple, but any type of transformation could be done here. The `BarWriter` will be used to write out `Bar` objects, throwing an exception if any other type is provided. Similarly, the `FooProcessor` will throw an exception if anything but a `Foo` is provided. The `FooProcessor` can then be injected into a `Step`:

```

<job id="ioSampleJob">
  <step name="step1">
    <tasklet>
      <chunk reader="fooReader" processor="fooProcessor" writer="barWriter"
        commit-interval="2"/>
    </tasklet>
  </step>
</job>

```

6.3.1. Chaining ItemProcessors

Performing a single transformation is useful in many scenarios, but what if you want to 'chain' together multiple `ItemProcessors`? This can be accomplished using the composite pattern mentioned previously. To update the previous, single transformation, example, `Foo` will be transformed to `Bar`, which will be transformed to `FooBar` and written out:

```

public class Foo {}

public class Bar {
    public Bar(Foo foo) {}
}

public class FooBar{
    public FooBar(Bar bar) {}
}

public class FooProcessor implements ItemProcessor<Foo,Bar>{
    public Bar process(Foo foo) throws Exception {
        //Perform simple transformation, convert a Foo to a Bar
        return new Bar(foo);
    }
}

public class BarProcessor implements ItemProcessor<Bar,FooBar>{
    public FooBar process(Bar bar) throws Exception {
        return new FooBar(bar);
    }
}

```

```
public class FoobarWriter implements ItemWriter<Foobar>{
    public void write(List<? extends Foobar> items) throws Exception {
        //write items
    }
}
```

A `FooProcessor` and `BarProcessor` can be 'chained' together to give the resultant `Foobar`:

```
CompositeItemProcessor<Foo,Foobar> compositeProcessor =
    new CompositeItemProcessor<Foo,Foobar>();
List itemProcessors = new ArrayList();
itemProcessors.add(new FooTransformer());
itemProcessors.add(new BarTransformer());
compositeProcessor.setItemProcessors(itemProcessors);
```

Just as with the previous example, the composite processor can be configured into the `Step`:

```
<job id="ioSampleJob">
  <step name="step1">
    <tasklet>
      <chunk reader="fooReader" processor="compositeProcessor" writer="foobarWriter"
        commit-interval="2"/>
    </tasklet>
  </step>
</job>

<bean id="compositeItemProcessor"
  class="org.springframework.batch.item.support.CompositeItemProcessor">
  <property name="itemProcessors">
    <list>
      <bean class="..FooProcessor" />
      <bean class="..BarProcessor" />
    </list>
  </property>
</bean>
```

6.3.2. Filtering Records

One typical use for an item processor is to filter out records before they are passed to the `ItemWriter`. Filtering is an action distinct from skipping; skipping indicates that a record is invalid whereas filtering simply indicates that a record should not be written.

For example, consider a batch job that reads a file containing three different types of records: records to insert, records to update, and records to delete. If record deletion is not supported by the system, then we would not want to send any "delete" records to the `ItemWriter`. But, since these records are not actually bad records, we would want to filter them out, rather than skip. As a result, the `ItemWriter` would receive only "insert" and "update" records.

To filter a record, one simply returns "null" from the `ItemProcessor`. The framework will detect that the result is "null" and avoid adding that item to the list of records delivered to the `ItemWriter`. As usual, an exception thrown from the `ItemProcessor` will result in a skip.

6.4. ItemStream

Both `ItemReaders` and `ItemWriters` serve their individual purposes well, but there is a common concern among both of them that necessitates another interface. In general, as part of the scope of a batch job, readers and writers need to be opened, closed, and require a mechanism for persisting state:

```
public interface ItemStream {
```

```

void open(ExecutionContext executionContext) throws ItemStreamException;

void update(ExecutionContext executionContext) throws ItemStreamException;

void close() throws ItemStreamException;
}

```

Before describing each method, we should mention the `ExecutionContext`. Clients of an `ItemReader` that also implement `ItemStream` should call `open` before any calls to `read` in order to open any resources such as files or to obtain connections. A similar restriction applies to an `ItemWriter` that implements `ItemStream`. As mentioned in Chapter 2, if expected data is found in the `ExecutionContext`, it may be used to start the `ItemReader` or `ItemWriter` at a location other than its initial state. Conversely, `close` will be called to ensure that any resources allocated during `open` will be released safely. `update` is called primarily to ensure that any state currently being held is loaded into the provided `ExecutionContext`. This method will be called before committing, to ensure that the current state is persisted in the database before commit.

In the special case where the client of an `ItemStream` is a `Step` (from the Spring Batch Core), an `ExecutionContext` is created for each `StepExecution` to allow users to store the state of a particular execution, with the expectation that it will be returned if the same `JobInstance` is started again. For those familiar with Quartz, the semantics are very similar to a Quartz `JobDataMap`.

6.5. The Delegate Pattern and Registering with the Step

Note that the `CompositeItemWriter` is an example of the delegation pattern, which is common in Spring Batch. The delegates themselves might implement callback interfaces like `ItemStream` or `StepListener`. If they do, and they are being used in conjunction with Spring Batch Core as part of a `Step` in a `Job`, then they almost certainly need to be registered manually with the `Step`. A reader, writer, or processor that is directly wired into the `Step` will be registered automatically if it implements `ItemStream` or a `StepListener` interface. But because the delegates are not known to the `Step`, they need to be injected as listeners or streams (or both if appropriate):

```

<job id="ioSampleJob">
  <step name="step1">
    <tasklet>
      <chunk reader="fooReader" processor="fooProcessor" writer="compositeItemWriter"
        commit-interval="2">
        <streams>
          <stream ref="barWriter" />
        </streams>
      </chunk>
    </tasklet>
  </step>
</job>

<bean id="compositeItemWriter" class="...CompositeItemWriter">
  <property name="delegate" ref="barWriter" />
</bean>

<bean id="barWriter" class="...BarWriter" />

```

6.6. Flat Files

One of the most common mechanisms for interchanging bulk data has always been the flat file. Unlike XML, which has an agreed upon standard for defining how it is structured (XSD), anyone reading a

flat file must understand ahead of time exactly how the file is structured. In general, all flat files fall into two types: Delimited and Fixed Length. Delimited files are those in which fields are separated by a delimiter, such as a comma. Fixed Length files have fields that are a set length.

6.6.1. The FieldSet

When working with flat files in Spring Batch, regardless of whether it is for input or output, one of the most important classes is the `FieldSet`. Many architectures and libraries contain abstractions for helping you read in from a file, but they usually return a `String` or an array of `Strings`. This really only gets you halfway there. A `FieldSet` is Spring Batch's abstraction for enabling the binding of fields from a file resource. It allows developers to work with file input in much the same way as they would work with database input. A `FieldSet` is conceptually very similar to a `JdbcResultSet`. `FieldSets` only require one argument, a `String` array of tokens. Optionally, you can also configure in the names of the fields so that the fields may be accessed either by index or name as patterned after `ResultSet`:

```
String[] tokens = new String[]{"foo", "1", "true"};
FieldSet fs = new DefaultFieldSet(tokens);
String name = fs.readString(0);
int value = fs.readInt(1);
boolean booleanValue = fs.readBoolean(2);
```

There are many more options on the `FieldSet` interface, such as `Date`, `long`, `BigDecimal`, etc. The biggest advantage of the `FieldSet` is that it provides consistent parsing of flat file input. Rather than each batch job parsing differently in potentially unexpected ways, it can be consistent, both when handling errors caused by a format exception, or when doing simple data conversions.

6.6.2. FlatFileItemReader

A flat file is any type of file that contains at most two-dimensional (tabular) data. Reading flat files in the Spring Batch framework is facilitated by the class `FlatFileItemReader`, which provides basic functionality for reading and parsing flat files. The two most important required dependencies of `FlatFileItemReader` are `Resource` and `LineMapper`. The `LineMapper` interface will be explored more in the next sections. The resource property represents a Spring Core `Resource`. Documentation explaining how to create beans of this type can be found in [Spring Framework, Chapter 4.Resources](#). Therefore, this guide will not go into the details of creating `Resource` objects. However, a simple example of a file system resource can be found below:

```
Resource resource = new FileSystemResource("resources/trades.csv");
```

In complex batch environments the directory structures are often managed by the EAI infrastructure where drop zones for external interfaces are established for moving files from ftp locations to batch processing locations and vice versa. File moving utilities are beyond the scope of the spring batch architecture but it is not unusual for batch job streams to include file moving utilities as steps in the job stream. It is sufficient that the batch architecture only needs to know how to locate the files to be processed. Spring Batch begins the process of feeding the data into the pipe from this starting point. However, [Spring Integration](#) provides many of these types of services.

The other properties in `FlatFileItemReader` allow you to further specify how your data will be interpreted:

Table 6.1. FlatFileItemReader Properties

Property	Type	Description
comments	String[]	Specifies line prefixes that indicate comment rows
encoding	String	Specifies what text encoding to use - default is "ISO-8859-1"
lineMapper	LineMapper	Converts a <code>String</code> to an <code>Object</code> representing the item.
linesToSkip	int	Number of lines to ignore at the top of the file
recordSeparatorPolicy	RecordSeparatorPolicy	Used to determine where the line endings are and do things like continue over a line ending if inside a quoted string.
resource	Resource	The resource from which to read.
skippedLinesCallback	LineCallbackHandler	Interface which passes the raw line content of the lines in the file to be skipped. If <code>linesToSkip</code> is set to 2, then this interface will be called twice.
strict	boolean	In strict mode, the reader will throw an exception on <code>ExecutionContext</code> if the input resource does not exist.

6.6.2.1. LineMapper

As with `RowMapper`, which takes a low level construct such as `ResultSet` and returns an `Object`, flat file processing requires the same construct to convert a `String` line into an `Object`:

```
public interface LineMapper<T> {
    T mapLine(String line, int lineNumber) throws Exception;
}
```

The basic contract is that, given the current line and the line number with which it is associated, the mapper should return a resulting domain object. This is similar to `RowMapper` in that each line is associated with its line number, just as each row in a `ResultSet` is tied to its row number. This allows the line number to be tied to the resulting domain object for identity comparison or for more informative logging. However, unlike `RowMapper`, the `LineMapper` is given a raw line which, as discussed above, only gets you halfway there. The line must be tokenized into a `FieldSet`, which can then be mapped to an object, as described below.

6.6.2.2. LineTokenizer

An abstraction for turning a line of input into a line into a `FieldSet` is necessary because there can be many formats of flat file data that need to be converted to a `FieldSet`. In Spring Batch, this interface is the `LineTokenizer`:

```
public interface LineTokenizer {
    FieldSet tokenize(String line);
}
```

The contract of a `LineTokenizer` is such that, given a line of input (in theory the `String` could encompass more than one line), a `FieldSet` representing the line will be returned. This `FieldSet` can then be passed to a `FieldSetMapper`. Spring Batch contains the following `LineTokenizer` implementations:

- `DelimitedLineTokenizer` - Used for files where fields in a record are separated by a delimiter. The most common delimiter is a comma, but pipes or semicolons are often used as well.
- `FixedLengthTokenizer` - Used for files where fields in a record are each a 'fixed width'. The width of each field must be defined for each record type.
- `PatternMatchingCompositeLineTokenizer` - Determines which among a list of `LineTokenizers` should be used on a particular line by checking against a pattern.

6.6.2.3. FieldSetMapper

The `FieldSetMapper` interface defines a single method, `mapFieldSet`, which takes a `FieldSet` object and maps its contents to an object. This object may be a custom DTO, a domain object, or a simple array, depending on the needs of the job. The `FieldSetMapper` is used in conjunction with the `LineTokenizer` to translate a line of data from a resource into an object of the desired type:

```
public interface FieldSetMapper<T> {
    T mapFieldSet(FieldSet fieldSet);
}
```

The pattern used is the same as the `RowMapper` used by `JdbcTemplate`.

6.6.2.4. DefaultLineMapper

Now that the basic interfaces for reading in flat files have been defined, it becomes clear that three basic steps are required:

1. Read one line from the file.
2. Pass the string line into the `LineTokenizer#tokenize()` method, in order to retrieve a `FieldSet`.
3. Pass the `FieldSet` returned from tokenizing to a `FieldSetMapper`, returning the result from the `ItemReader#read()` method.

The two interfaces described above represent two separate tasks: converting a line into a `FieldSet`, and mapping a `FieldSet` to a domain object. Because the input of a `LineTokenizer` matches the input of the `LineMapper` (a line), and the output of a `FieldSetMapper` matches the output of the `LineMapper`,

a default implementation that uses both a `LineTokenizer` and `FieldSetMapper` is provided. The `DefaultLineMapper` represents the behavior most users will need:

```
public class DefaultLineMapper<T> implements LineMapper<T>, InitializingBean {

    private LineTokenizer tokenizer;

    private FieldSetMapper<T> fieldSetMapper;

    public T mapLine(String line, int lineNumber) throws Exception {
        return fieldSetMapper.mapFieldSet(tokenizer.tokenize(line));
    }

    public void setLineTokenizer(LineTokenizer tokenizer) {
        this.tokenizer = tokenizer;
    }

    public void setFieldSetMapper(FieldSetMapper<T> fieldSetMapper) {
        this.fieldSetMapper = fieldSetMapper;
    }
}
```

The above functionality is provided in a default implementation, rather than being built into the reader itself (as was done in previous versions of the framework) in order to allow users greater flexibility in controlling the parsing process, especially if access to the raw line is needed.

6.6.2.5. Simple Delimited File Reading Example

The following example will be used to illustrate this using an actual domain scenario. This particular batch job reads in football players from the following file:

```
ID,lastName,firstName,position,birthYear,debutYear
"AbduKa00,Abdul-Jabbar,Karim,rb,1974,1996",
"AbduRa00,Abdullah,Rabih,rb,1975,1999",
"AberWa00,Abercrombie,Walter,rb,1959,1982",
"AbraDa00,Abramowicz,Danny,wr,1945,1967",
"AdamBo00,Adams,Bob,te,1946,1969",
"AdamCh00,Adams,Charlie,wr,1979,2003"
```

The contents of this file will be mapped to the following `Player` domain object:

```
public class Player implements Serializable {

    private String ID;
    private String lastName;
    private String firstName;
    private String position;
    private int birthYear;
    private int debutYear;

    public String toString() {
        return "PLAYER:ID=" + ID + ",Last Name=" + lastName +
            ",First Name=" + firstName + ",Position=" + position +
            ",Birth Year=" + birthYear + ",DebutYear=" +
            debutYear;
    }

    // setters and getters...
}
```

In order to map a `FieldSet` into a `Player` object, a `FieldSetMapper` that returns players needs to be defined:

```
protected static class PlayerFieldSetMapper implements FieldSetMapper<Player> {
    public Player mapFieldSet(FieldSet fieldSet) {
        Player player = new Player();

        player.setID(fieldSet.readString(0));
        player.setLastName(fieldSet.readString(1));
        player.setFirstName(fieldSet.readString(2));
        player.setPosition(fieldSet.readString(3));
        player.setBirthYear(fieldSet.readInt(4));
        player.setDebutYear(fieldSet.readInt(5));

        return player;
    }
}
```

The file can then be read by correctly constructing a `FlatFileItemReader` and calling `read`:

```
FlatFileItemReader<Player> itemReader = new FlatFileItemReader<Player>();
itemReader.setResource(new FileSystemResource("resources/players.csv"));
//DelimitedLineTokenizer defaults to comma as its delimiter
LineMapper<Player> lineMapper = new DefaultLineMapper<Player>();
lineMapper.setLineTokenizer(new DelimitedLineTokenizer());
lineMapper.setFieldSetMapper(new PlayerFieldSetMapper());
itemReader.setLineMapper(lineMapper);
itemReader.open(new ExecutionContext());
Player player = itemReader.read();
```

Each call to `read` will return a new `Player` object from each line in the file. When the end of the file is reached, `null` will be returned.

6.6.2.6. Mapping Fields by Name

There is one additional piece of functionality that is allowed by both `DelimitedLineTokenizer` and `FixedLengthTokenizer` that is similar in function to a `Jdbc ResultSet`. The names of the fields can be injected into either of these `LineTokenizer` implementations to increase the readability of the mapping function. First, the column names of all fields in the flat file are injected into the tokenizer:

```
tokenizer.setNames(new String[] {"ID", "lastName", "firstName", "position", "birthYear", "debutYear"});
```

A `FieldSetMapper` can use this information as follows:

```
public class PlayerMapper implements FieldSetMapper<Player> {
    public Player mapFieldSet(FieldSet fs) {

        if(fs == null){
            return null;
        }

        Player player = new Player();
        player.setID(fs.readString("ID"));
        player.setLastName(fs.readString("lastName"));
        player.setFirstName(fs.readString("firstName"));
        player.setPosition(fs.readString("position"));
        player.setDebutYear(fs.readInt("debutYear"));
        player.setBirthYear(fs.readInt("birthYear"));

        return player;
    }
}
```

6.6.2.7. Automapping FieldSets to Domain Objects

For many, having to write a specific `FieldSetMapper` is equally as cumbersome as writing a specific `RowMapper` for a `JdbcTemplate`. Spring Batch makes this easier by providing a `FieldSetMapper` that automatically maps fields by matching a field name with a setter on the object using the JavaBean specification. Again using the football example, the `BeanWrapperFieldSetMapper` configuration looks like the following:

```
<bean id="fieldSetMapper"
      class="org.springframework.batch.item.file.mapping.BeanWrapperFieldSetMapper">
  <property name="prototypeBeanName" value="player" />
</bean>

<bean id="player"
      class="org.springframework.batch.sample.domain.Player"
      scope="prototype" />
```

For each entry in the `FieldSet`, the mapper will look for a corresponding setter on a new instance of the `Player` object (for this reason, prototype scope is required) in the same way the Spring container will look for setters matching a property name. Each available field in the `FieldSet` will be mapped, and the resultant `Player` object will be returned, with no code required.

6.6.2.8. Fixed Length File Formats

So far only delimited files have been discussed in much detail, however, they represent only half of the file reading picture. Many organizations that use flat files use fixed length formats. An example fixed length file is below:

```
UK21341EAH4121131.11customer1
UK21341EAH4221232.11customer2
UK21341EAH4321333.11customer3
UK21341EAH4421434.11customer4
UK21341EAH4521535.11customer5
```

While this looks like one large field, it actually represent 4 distinct fields:

1. ISIN: Unique identifier for the item being order - 12 characters long.
2. Quantity: Number of this item being ordered - 3 characters long.
3. Price: Price of the item - 5 characters long.
4. Customer: Id of the customer ordering the item - 9 characters long.

When configuring the `FixedLengthLineTokenizer`, each of these lengths must be provided in the form of ranges:

```
<bean id="fixedLengthLineTokenizer"
      class="org.springframework.batch.io.file.transform.FixedLengthTokenizer">
  <property name="names" value="ISIN,Quantity,Price,Customer" />
  <property name="columns" value="1-12, 13-15, 16-20, 21-29" />
</bean>
```

Because the `FixedLengthLineTokenizer` uses the same `LineTokenizer` interface as discussed above, it will return the same `FieldSet` as if a delimiter had been used. This allows the same approaches to be used in handling its output, such as using the `BeanWrapperFieldSetMapper`.



Note

Supporting the above syntax for ranges requires that a specialized property editor, `RangeArrayPropertyEditor`, be configured in the `ApplicationContext`. However, this bean is automatically declared in an `ApplicationContext` where the batch namespace is used.

6.6.2.9. Multiple Record Types within a Single File

All of the file reading examples up to this point have all made a key assumption for simplicity's sake: all of the records in a file have the same format. However, this may not always be the case. It is very common that a file might have records with different formats that need to be tokenized differently and mapped to different objects. The following excerpt from a file illustrates this:

```
USER;Smith;Peter;;T;20014539;F
LINEA;1044391041ABC037.49G201XX1383.12H
LINEB;2134776319DEF422.99M005LI
```

In this file we have three types of records, "USER", "LINEA", and "LINEB". A "USER" line corresponds to a `User` object. "LINEA" and "LINEB" both correspond to `Line` objects, though a "LINEA" has more information than a "LINEB".

The `ItemReader` will read each line individually, but we must specify different `LineTokenizer` and `FieldSetMapper` objects so that the `ItemWriter` will receive the correct items. The `PatternMatchingCompositeLineMapper` makes this easy by allowing maps of patterns to `LineTokenizers` and patterns to `FieldSetMappers` to be configured:

```
<bean id="orderFileLineMapper"
  class="org.springframework.batch.core.io.PatternMatchingCompositeLineMapper">
  <property name="tokenizers">
    <map>
      <entry key="USER*" value-ref="userTokenizer" />
      <entry key="LINEA*" value-ref="lineATokenizer" />
      <entry key="LINEB*" value-ref="lineBTokenizer" />
    </map>
  </property>
  <property name="fieldSetMappers">
    <map>
      <entry key="USER*" value-ref="userFieldSetMapper" />
      <entry key="LINE*" value-ref="lineFieldSetMapper" />
    </map>
  </property>
</bean>
```

In this example, "LINEA" and "LINEB" have separate `LineTokenizers` but they both use the same `FieldSetMapper`.

The `PatternMatchingCompositeLineMapper` makes use of the `PatternMatcher`'s `match` method in order to select the correct delegate for each line. The `PatternMatcher` allows for two wildcard characters with special meaning: the question mark ("?") will match exactly one character, while the asterisk ("*") will match zero or more characters. Note that in the configuration above, all patterns end with an asterisk, making them effectively prefixes to lines. The `PatternMatcher` will always match the most specific pattern possible, regardless of the order in the configuration. So if "LINE*" and "LINEA*" were both listed as patterns, "LINEA" would match pattern "LINEA*", while "LINEB" would match pattern "LINE*". Additionally, a single asterisk ("*") can serve as a default by matching any line not matched by any other pattern.

```
<entry key="*" value-ref="defaultLineTokenizer" />
```

There is also a `PatternMatchingCompositeLineTokenizer` that can be used for tokenization alone.

It is also common for a flat file to contain records that each span multiple lines. To handle this situation, a more complex strategy is required. A demonstration of this common pattern can be found in Section 11.5, “Multi-Line Records”.

6.6.2.10. Exception Handling in Flat Files

There are many scenarios when tokenizing a line may cause exceptions to be thrown. Many flat files are imperfect and contain records that aren't formatted correctly. Many users choose to skip these erroneous lines, logging out the issue, original line, and line number. These logs can later be inspected manually or by another batch job. For this reason, Spring Batch provides a hierarchy of exceptions for handling parse exceptions: `FlatFileParseException` and `FlatFileFormatException`. `FlatFileParseException` is thrown by the `FlatFileItemReader` when any errors are encountered while trying to read a file. `FlatFileFormatException` is thrown by implementations of the `LineTokenizer` interface, and indicates a more specific error encountered while tokenizing.

6.6.2.10.1. IncorrectTokenCountException

Both `DelimitedLineTokenizer` and `FixedLengthLineTokenizer` have the ability to specify column names that can be used for creating a `FieldSet`. However, if the number of column names doesn't match the number of columns found while tokenizing a line the `FieldSet` can't be created, and an `IncorrectTokenCountException` is thrown, which contains the number of tokens encountered, and the number expected:

```
tokenizer.setNames(new String[] {"A", "B", "C", "D"});

try{
    tokenizer.tokenize("a,b,c");
}
catch(IncorrectTokenCountException e){
    assertEquals(4, e.getExpectedCount());
    assertEquals(3, e.getActualCount());
}
```

Because the tokenizer was configured with 4 column names, but only 3 tokens were found in the file, an `IncorrectTokenCountException` was thrown.

6.6.2.10.2. IncorrectLineLengthException

Files formatted in a fixed length format have additional requirements when parsing because, unlike a delimited format, each column must strictly adhere to its predefined width. If the total line length doesn't add up to the widest value of this column, an exception is thrown:

```
tokenizer.setColumns(new Range[] { new Range(1, 5),
                                   new Range(6, 10),
                                   new Range(11, 15) });

try {
    tokenizer.tokenize("12345");
    fail("Expected IncorrectLineLengthException");
}
catch (IncorrectLineLengthException ex) {
    assertEquals(15, ex.getExpectedLength());
    assertEquals(5, ex.getActualLength());
}
```

```
}

```

The configured ranges for the tokenizer above are: 1-5, 6-10, and 11-15, thus the total length of the line expected is 15. However, in this case a line of length 5 was passed in, causing an `IncorrectLineLengthException` to be thrown. Throwing an exception here rather than only mapping the first column allows the processing of the line to fail earlier, and with more information than it would if it failed while trying to read in column 2 in a `FieldSetMapper`. However, there are scenarios where the length of the line isn't always constant. For this reason, validation of line length can be turned off via the 'strict' property:

```
tokenizer.setColumns(new Range[] { new Range(1, 5), new Range(6, 10) });
tokenizer.setStrict(false);
FieldSet tokens = tokenizer.tokenize("12345");
assertEquals("12345", tokens.readString(0));
assertEquals("", tokens.readString(1));
```

The above example is almost identical to the one before it, except that `tokenizer.setStrict(false)` was called. This setting tells the tokenizer to not enforce line lengths when tokenizing the line. A `FieldSet` is now correctly created and returned. However, it will only contain empty tokens for the remaining values.

6.6.3. FlatFileItemWriter

Writing out to flat files has the same problems and issues that reading in from a file must overcome. A step must be able to write out in either delimited or fixed length formats in a transactional manner.

6.6.3.1. LineAggregator

Just as the `LineTokenizer` interface is necessary to take an item and turn it into a `String`, file writing must have a way to aggregate multiple fields into a single string for writing to a file. In Spring Batch this is the `LineAggregator`:

```
public interface LineAggregator<T> {
    public String aggregate(T item);
}
```

The `LineAggregator` is the opposite of a `LineTokenizer`. `LineTokenizer` takes a `String` and returns a `FieldSet`, whereas `LineAggregator` takes an item and returns a `String`.

6.6.3.1.1. PassThroughLineAggregator

The most basic implementation of the `LineAggregator` interface is the `PassThroughLineAggregator`, which simply assumes that the object is already a string, or that its string representation is acceptable for writing:

```
public class PassThroughLineAggregator<T> implements LineAggregator<T> {
    public String aggregate(T item) {
        return item.toString();
    }
}
```

The above implementation is useful if direct control of creating the string is required, but the advantages of a `FlatFileItemWriter`, such as transaction and restart support, are necessary.

6.6.3.2. Simplified File Writing Example

Now that the `LineAggregator` interface and its most basic implementation, `PassThroughLineAggregator`, have been defined, the basic flow of writing can be explained:

1. The object to be written is passed to the `LineAggregator` in order to obtain a `String`.
2. The returned `String` is written to the configured file.

The following excerpt from the `FlatFileItemWriter` expresses this in code:

```
public void write(T item) throws Exception {
    write(lineAggregator.aggregate(item) + LINE_SEPARATOR);
}
```

A simple configuration would look like the following:

```
<bean id="itemWriter" class="org.spr...FlatFileItemWriter">
  <property name="resource" value="file:target/test-outputs/output.txt" />
  <property name="lineAggregator">
    <bean class="org.spr...PassThroughLineAggregator" />
  </property>
</bean>
```

6.6.3.3. FieldExtractor

The above example may be useful for the most basic uses of a writing to a file. However, most users of the `FlatFileItemWriter` will have a domain object that needs to be written out, and thus must be converted into a line. In file reading, the following was required:

1. Read one line from the file.
2. Pass the string line into the `LineTokenizer#tokenize()` method, in order to retrieve a `FieldSet`
3. Pass the `FieldSet` returned from tokenizing to a `FieldSetMapper`, returning the result from the `ItemReader#read()` method

File writing has similar, but inverse steps:

1. Pass the item to be written to the writer
2. convert the fields on the item into an array
3. aggregate the resulting array into a line

Because there is no way for the framework to know which fields from the object need to be written out, a `FieldExtractor` must be written to accomplish the task of turning the item into an array:

```
public interface FieldExtractor<T> {
    Object[] extract(T item);
}
```

Implementations of the `FieldExtractor` interface should create an array from the fields of the provided object, which can then be written out with a delimiter between the elements, or as part of a field-width line.

6.6.3.3.1. PassThroughFieldExtractor

There are many cases where a collection, such as an array, `Collection`, or `FieldSet`, needs to be written out. "Extracting" an array from a one of these collection types is very straightforward: simply convert the collection to an array. Therefore, the `PassThroughFieldExtractor` should be used in this scenario. It should be noted, that if the object passed in is not a type of collection, then the `PassThroughFieldExtractor` will return an array containing solely the item to be extracted.

6.6.3.3.2. BeanWrapperFieldExtractor

As with the `BeanWrapperFieldSetMapper` described in the file reading section, it is often preferable to configure how to convert a domain object to an object array, rather than writing the conversion yourself. The `BeanWrapperFieldExtractor` provides just this type of functionality:

```
BeanWrapperFieldExtractor<Name> extractor = new BeanWrapperFieldExtractor<Name>();
extractor.setNames(new String[] { "first", "last", "born" });

String first = "Alan";
String last = "Turing";
int born = 1912;

Name n = new Name(first, last, born);
Object[] values = extractor.extract(n);

assertEquals(first, values[0]);
assertEquals(last, values[1]);
assertEquals(born, values[2]);
```

This extractor implementation has only one required property, the names of the fields to map. Just as the `BeanWrapperFieldSetMapper` needs field names to map fields on the `FieldSet` to setters on the provided object, the `BeanWrapperFieldExtractor` needs names to map to getters for creating an object array. It is worth noting that the order of the names determines the order of the fields within the array.

6.6.3.4. Delimited File Writing Example

The most basic flat file format is one in which all fields are separated by a delimiter. This can be accomplished using a `DelimitedLineAggregator`. The example below writes out a simple domain object that represents a credit to a customer account:

```
public class CustomerCredit {

    private int id;
    private String name;
    private BigDecimal credit;

    //getters and setters removed for clarity
}
```

Because a domain object is being used, an implementation of the `FieldExtractor` interface must be provided, along with the delimiter to use:

```
<bean id="itemWriter" class="org.springframework.batch.item.file.FlatFileItemWriter">
  <property name="resource" ref="outputResource" />
  <property name="lineAggregator">
    <bean class="org.springframework.batch.item.file.delimited.DelimitedLineAggregator">
      <property name="delimiter" value="," />
      <property name="fieldExtractor">
        <bean class="org.springframework.batch.item.file.delimited.BeanWrapperFieldExtractor">
          <property name="names" value="name,credit"/>
        </bean>
      </property>
    </bean>
  </property>
</bean>
```

```

        </bean>
    </property>
</bean>
</property>
</bean>

```

In this case, the `BeanWrapperFieldExtractor` described earlier in this chapter is used to turn the name and credit fields within `CustomerCredit` into an object array, which is then written out with commas between each field.

6.6.3.5. Fixed Width File Writing Example

Delimited is not the only type of flat file format. Many prefer to use a set width for each column to delineate between fields, which is usually referred to as 'fixed width'. Spring Batch supports this in file writing via the `FormatterLineAggregator`. Using the same `CustomerCredit` domain object described above, it can be configured as follows:

```

<bean id="itemWriter" class="org.springframework.batch.item.file.FlatFileItemWriter">
  <property name="resource" ref="outputResource" />
  <property name="lineAggregator">
    <bean class="org.spr...FormatterLineAggregator">
      <property name="fieldExtractor">
        <bean class="org.spr...BeanWrapperFieldExtractor">
          <property name="names" value="name,credit" />
        </bean>
      </property>
      <property name="format" value="%-9s%-2.0f" />
    </bean>
  </property>
</bean>

```

Most of the above example should look familiar. However, the value of the format property is new:

```

<property name="format" value="%-9s%-2.0f" />

```

The underlying implementation is built using the same `Formatter` added as part of Java 5. The Java `Formatter` is based on the `printf` functionality of the C programming language. Most details on how to configure a formatter can be found in the javadoc of [Formatter](#).

6.6.3.6. Handling File Creation

`FlatFileItemReader` has a very simple relationship with file resources. When the reader is initialized, it opens the file if it exists, and throws an exception if it does not. File writing isn't quite so simple. At first glance it seems like a similar straight forward contract should exist for `FlatFileItemWriter`: if the file already exists, throw an exception, and if it does not, create it and start writing. However, potentially restarting a `Job` can cause issues. In normal restart scenarios, the contract is reversed: if the file exists, start writing to it from the last known good position, and if it does not, throw an exception. However, what happens if the file name for this job is always the same? In this case, you would want to delete the file if it exists, unless it's a restart. Because of this possibility, the `FlatFileItemWriter` contains the property, `shouldDeleteIfExists`. Setting this property to true will cause an existing file with the same name to be deleted when the writer is opened.

6.7. XML Item Readers and Writers

Spring Batch provides transactional infrastructure for both reading XML records and mapping them to Java objects as well as writing Java objects as XML records.



Constraints on streaming XML

The StAX API is used for I/O as other standard XML parsing APIs do not fit batch processing requirements (DOM loads the whole input into memory at once and SAX controls the parsing process allowing the user only to provide callbacks).

Lets take a closer look how XML input and output works in Spring Batch. First, there are a few concepts that vary from file reading and writing but are common across Spring Batch XML processing. With XML processing, instead of lines of records (FieldSets) that need to be tokenized, it is assumed an XML resource is a collection of 'fragments' corresponding to individual records:

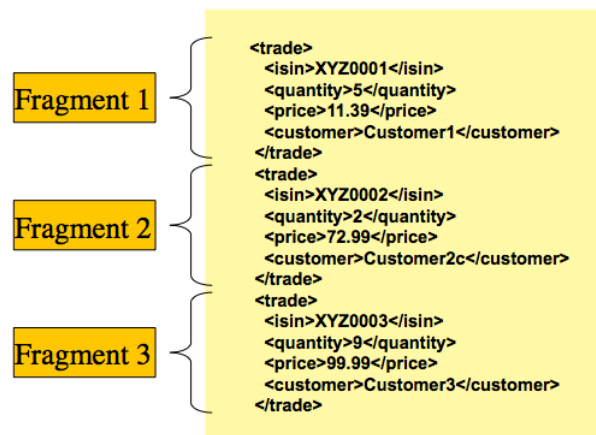

Figure 3.1: XML Input

The 'trade' tag is defined as the 'root element' in the scenario above. Everything between '<trade>' and '</trade>' is considered one 'fragment'. Spring Batch uses Object/XML Mapping (OXM) to bind fragments to objects. However, Spring Batch is not tied to any particular XML binding technology. Typical use is to delegate to [Spring OXM](#), which provides uniform abstraction for the most popular OXM technologies. The dependency on Spring OXM is optional and you can choose to implement Spring Batch specific interfaces if desired. The relationship to the technologies that OXM supports can be shown as the following:

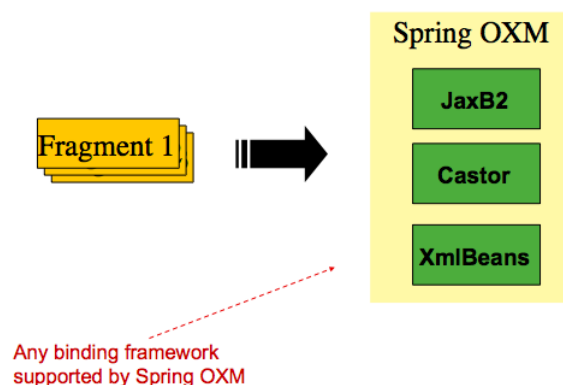

Figure 3.2: OXM Binding

Now with an introduction to OXM and how one can use XML fragments to represent records, let's take a closer look at readers and writers.

6.7.1. StaxEventItemReader

The `StaxEventItemReader` configuration provides a typical setup for the processing of records from an XML input stream. First, let's examine a set of XML records that the `StaxEventItemReader` can process.

```
<?xml version="1.0" encoding="UTF-8"?>
<records>
  <trade xmlns="http://springframework.org/batch/sample/io/oxm/domain">
    <isin>XYZ0001</isin>
    <quantity>5</quantity>
    <price>11.39</price>
    <customer>Customer1</customer>
  </trade>
  <trade xmlns="http://springframework.org/batch/sample/io/oxm/domain">
    <isin>XYZ0002</isin>
    <quantity>2</quantity>
    <price>72.99</price>
    <customer>Customer2c</customer>
  </trade>
  <trade xmlns="http://springframework.org/batch/sample/io/oxm/domain">
    <isin>XYZ0003</isin>
    <quantity>9</quantity>
    <price>99.99</price>
    <customer>Customer3</customer>
  </trade>
</records>
```

To be able to process the XML records the following is needed:

- Root Element Name - Name of the root element of the fragment that constitutes the object to be mapped. The example configuration demonstrates this with the value of `trade`.
- Resource - Spring Resource that represents the file to be read.
- `FragmentDeserializer` - Unmarshalling facility provided by Spring OXM for mapping the XML fragment to an object.

```
<bean id="itemReader" class="org.springframework.batch.item.xml.StaxEventItemReader">
  <property name="fragmentRootElementName" value="customer" />
  <property name="resource" value="data/iosample/input/input.xml" />
  <property name="unmarshaller" ref="customerCreditMarshaller" />
</bean>

<bean id="customerCreditMarshaller"
  class="org.springframework.oxm.xstream.XStreamMarshaller">
  <property name="aliases">
    <util:map id="aliases">
      <entry key="customer"
        value="org.springframework.batch.sample.domain.CustomerCredit" />
      <entry key="price" value="java.math.BigDecimal" />
      <entry key="name" value="java.lang.String" />
    </util:map>
  </property>
</bean>
```

Notice that in this example we have chosen to use an `XStreamMarshaller` that requires an alias passed in as a map with the first key and value being the name of the fragment (i.e. root element) and the object type to bind. Then, similar to a `FieldSet`, the names of the other elements that map to fields within the object type are described as key/value pairs in the map. In the configuration file we can use a Spring configuration utility to describe the required alias as follows:

```

<bean id="itemReader" class="org.springframework.batch.item.xml.StaxEventItemReader">
  <property name="fragmentRootElementName" value="customer" />
  <property name="resource" value="data/iosample/input/input.xml" />
  <property name="unmarshaller" ref="customerCreditMarshaller" />
</bean>

<bean id="customerCreditMarshaller"
  class="org.springframework.xml.xstream.XStreamMarshaller">
  <property name="aliases">
    <util:map id="aliases">
      <entry key="customer"
        value="org.springframework.batch.sample.domain.CustomerCredit" />
      <entry key="price" value="java.math.BigDecimal" />
      <entry key="name" value="java.lang.String" />
    </util:map>
  </property>
</bean>

```

On input the reader reads the XML resource until it recognizes that a new fragment is about to start (by matching the tag name by default). The reader creates a standalone XML document from the fragment (or at least makes it appear so) and passes the document to a deserializer (typically a wrapper around a Spring OXM `Unmarshaller`) to map the XML to a Java object.

In summary, this procedure is analogous to the following scripted Java code which uses the injection provided by the Spring configuration:

```

StaxEventItemReader xmlStaxEventItemReader = new StaxEventItemReader()
Resource resource = new ByteArrayResource(xmlResource.getBytes())

Map aliases = new HashMap();
aliases.put("customer", "org.springframework.batch.sample.domain.CustomerCredit");
aliases.put("price", "java.math.BigDecimal");
aliases.put("name", "java.lang.String");
Marshaller marshaller = new XStreamMarshaller();
marshaller.setAliases(aliases);
xmlStaxEventItemReader.setUnmarshaller(marshaller);
xmlStaxEventItemReader.setResource(resource);
xmlStaxEventItemReader.setFragmentRootElementName("customer");
xmlStaxEventItemReader.open(new ExecutionContext());

boolean hasNext = true

CustomerCredit credit = null;

while (hasNext) {
  credit = xmlStaxEventItemReader.read();
  if (credit == null) {
    hasNext = false;
  }
  else {
    System.out.println(credit);
  }
}

```

6.7.2. StaxEventItemWriter

Output works symmetrically to input. The `StaxEventItemWriter` needs a `Resource`, a serializer, and a `rootTagName`. A Java object is passed to a serializer (typically a wrapper around Spring OXM `Marshaller`) which writes to a `Resource` using a custom event writer that filters the `StartDocument` and `EndDocument` events produced for each fragment by the OXM tools. We'll show this in an example

using the `MarshallingEventWriterSerializer`. The Spring configuration for this setup looks as follows:

```
<bean id="itemWriter" class="org.springframework.batch.item.xml.StaxEventItemWriter">
  <property name="resource" ref="outputResource" />
  <property name="marshaller" ref="customerCreditMarshaller" />
  <property name="rootTagName" value="customers" />
  <property name="overwriteOutput" value="true" />
</bean>
```

The configuration sets up the three required properties and optionally sets the `overwriteOutput=true`, mentioned earlier in the chapter for specifying whether an existing file can be overwritten. It should be noted the marshaller used for the writer is the exact same as the one used in the reading example from earlier in the chapter:

```
<bean id="customerCreditMarshaller"
  class="org.springframework.oxm.xstream.XStreamMarshaller">
  <property name="aliases">
    <util:map id="aliases">
      <entry key="customer"
        value="org.springframework.batch.sample.domain.CustomerCredit" />
      <entry key="price" value="java.math.BigDecimal" />
      <entry key="name" value="java.lang.String" />
    </util:map>
  </property>
</bean>
```

To summarize with a Java example, the following code illustrates all of the points discussed, demonstrating the programmatic setup of the required properties:

```
StaxEventItemWriter staxItemWriter = new StaxEventItemWriter()
FileSystemResource resource = new FileSystemResource("data/outputFile.xml")

Map aliases = new HashMap();
aliases.put("customer", "org.springframework.batch.sample.domain.CustomerCredit");
aliases.put("price", "java.math.BigDecimal");
aliases.put("name", "java.lang.String");
Marshaller marshaller = new XStreamMarshaller();
marshaller.setAliases(aliases);

staxItemWriter.setResource(resource);
staxItemWriter.setMarshaller(marshaller);
staxItemWriter.setRootTagName("trades");
staxItemWriter.setOverwriteOutput(true);

ExecutionContext executionContext = new ExecutionContext();
staxItemWriter.open(executionContext);
CustomerCredit credit = new CustomerCredit();
trade.setPrice(11.39);
credit.setName("Customer1");
staxItemWriter.write(trade);
```

6.8. Multi-File Input

It is a common requirement to process multiple files within a single `Step`. Assuming the files all have the same formatting, the `MultiResourceItemReader` supports this type of input for both XML and flat file processing. Consider the following files in a directory:

```
file-1.txt  file-2.txt  ignored.txt
```

file-1.txt and file-2.txt are formatted the same and for business reasons should be processed together. The `MultiResourceItemReader` can be used to read in both files by using wildcards:

```
<bean id="multiResourceReader" class="org.spr...MultiResourceItemReader">
  <property name="resources" value="classpath:data/input/file-*.txt" />
  <property name="delegate" ref="flatFileItemReader" />
</bean>
```

The referenced delegate is a simple `FlatFileItemReader`. The above configuration will read input from both files, handling rollback and restart scenarios. It should be noted that, as with any `ItemReader`, adding extra input (in this case a file) could cause potential issues when restarting. It is recommended that batch jobs work with their own individual directories until completed successfully.

6.9. Database

Like most enterprise application styles, a database is the central storage mechanism for batch. However, batch differs from other application styles due to the sheer size of the datasets with which the system must work. If a SQL statement returns 1 million rows, the result set probably holds all returned results in memory until all rows have been read. Spring Batch provides two types of solutions for this problem: Cursor and Paging database `ItemReaders`.

6.9.1. Cursor Based ItemReaders

Using a database cursor is generally the default approach of most batch developers, because it is the database's solution to the problem of 'streaming' relational data. The Java `ResultSet` class is essentially an object orientated mechanism for manipulating a cursor. A `ResultSet` maintains a cursor to the current row of data. Calling `next` on a `ResultSet` moves this cursor to the next row. Spring Batch cursor based `ItemReaders` open the a cursor on initialization, and move the cursor forward one row for every call to `read`, returning a mapped object that can be used for processing. The `close` method will then be called to ensure all resources are freed up. The Spring core `JdbcTemplate` gets around this problem by using the callback pattern to completely map all rows in a `ResultSet` and close before returning control back to the method caller. However, in batch this must wait until the step is complete. Below is a generic diagram of how a cursor based `ItemReader` works, and while a SQL statement is used as an example since it is so widely known, any technology could implement the basic approach:

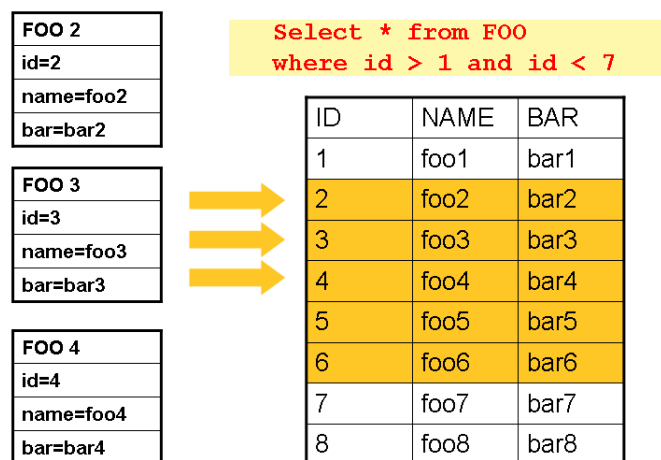

This example illustrates the basic pattern. Given a 'FOO' table, which has three columns: ID, NAME, and BAR, select all rows with an ID greater than 1 but less than 7. This puts the beginning of the cursor (row 1) on ID 2. The result of this row should be a completely mapped `Foo` object. Calling `read()` again moves the cursor to the next row, which is the `Foo` with an ID of 3. The results of these reads will be

written out after each `read`, thus allowing the objects to be garbage collected (assuming no instance variables are maintaining references to them).

6.9.1.1. JdbcCursorItemReader

`JdbcCursorItemReader` is the `Jdbc` implementation of the cursor based technique. It works directly with a `ResultSet` and requires a `SQL` statement to run against a connection obtained from a `DataSource`. The following database schema will be used as an example:

```
CREATE TABLE CUSTOMER (
  ID BIGINT IDENTITY PRIMARY KEY,
  NAME VARCHAR(45),
  CREDIT FLOAT
);
```

Many people prefer to use a domain object for each row, so we'll use an implementation of the `RowMapper` interface to map a `CustomerCredit` object:

```
public class CustomerCreditRowMapper implements RowMapper {

  public static final String ID_COLUMN = "id";
  public static final String NAME_COLUMN = "name";
  public static final String CREDIT_COLUMN = "credit";

  public Object mapRow(ResultSet rs, int rowNum) throws SQLException {
    CustomerCredit customerCredit = new CustomerCredit();

    customerCredit.setId(rs.getInt(ID_COLUMN));
    customerCredit.setName(rs.getString(NAME_COLUMN));
    customerCredit.setCredit(rs.getBigDecimal(CREDIT_COLUMN));

    return customerCredit;
  }
}
```

Because `JdbcTemplate` is so familiar to users of `Spring`, and the `JdbcCursorItemReader` shares key interfaces with it, it is useful to see an example of how to read in this data with `JdbcTemplate`, in order to contrast it with the `ItemReader`. For the purposes of this example, let's assume there are 1,000 rows in the `CUSTOMER` database. The first example will be using `JdbcTemplate`:

```
//For simplicity sake, assume a dataSource has already been obtained
JdbcTemplate jdbcTemplate = new JdbcTemplate(dataSource);
List customerCredits = jdbcTemplate.query("SELECT ID, NAME, CREDIT from CUSTOMER",
                                         new CustomerCreditRowMapper());
```

After running this code snippet the `customerCredits` list will contain 1,000 `CustomerCredit` objects. In the query method, a connection will be obtained from the `DataSource`, the provided `SQL` will be run against it, and the `mapRow` method will be called for each row in the `ResultSet`. Let's contrast this with the approach of the `JdbcCursorItemReader`:

```
JdbcCursorItemReader itemReader = new JdbcCursorItemReader();
itemReader.setDataSource(dataSource);
itemReader.setSql("SELECT ID, NAME, CREDIT from CUSTOMER");
itemReader.setRowMapper(new CustomerCreditRowMapper());
int counter = 0;
ExecutionContext executionContext = new ExecutionContext();
itemReader.open(executionContext);
Object customerCredit = new Object();
while(customerCredit != null){
  customerCredit = itemReader.read();
}
```



```
        counter++;
    }
    itemReader.close(executionContext);
```

After running this code snippet the counter will equal 1,000. If the code above had put the returned `customerCredit` into a list, the result would have been exactly the same as with the `JdbcTemplate` example. However, the big advantage of the `ItemReader` is that it allows items to be 'streamed'. The `read` method can be called once, and the item written out via an `ItemWriter`, and then the next item obtained via `read`. This allows item reading and writing to be done in 'chunks' and committed periodically, which is the essence of high performance batch processing. Furthermore, it is very easily configured for injection into a Spring Batch `Step`:

```
<bean id="itemReader" class="org.spr...JdbcCursorItemReader">
  <property name="dataSource" ref="dataSource"/>
  <property name="sql" value="select ID, NAME, CREDIT from CUSTOMER"/>
  <property name="rowMapper">
    <bean class="org.springframework.batch.sample.domain.CustomerCreditRowMapper"/>
  </property>
</bean>
```

6.9.1.1.1. Additional Properties

Because there are so many varying options for opening a cursor in Java, there are many properties on the `JdbcCursorItemReader` that can be set:

ignoreWarnings	Determines whether or not SQLWarnings are logged
ItemReaders and ItemWriters	cause an exception - default is true
fetchSize	Gives the Jdbc driver a hint as to the number of rows that should be fetched from the database when more rows are needed by the <code>ResultSet</code> object used by the <code>ItemReader</code> . By default, no hint is given.
maxRows	Sets the limit for the maximum number of rows the underlying <code>ResultSet</code> can hold at any one time.
queryTimeout	Sets the number of seconds the driver will wait for a <code>Statement</code> object to execute to the given number of seconds. If the limit is exceeded, a <code>DataAccessException</code> is thrown. (Consult your driver vendor documentation for details).
verifyCursorPosition	Because the same <code>ResultSet</code> held by the <code>ItemReader</code> is passed to the <code>RowMapper</code> , it is possible for users to call <code>ResultSet.next()</code> themselves, which could cause issues with the reader's internal count. Setting this value to true will cause an exception to be thrown if the cursor position is not the same after the <code>RowMapper</code> call as it was before.
saveState	Indicates whether or not the reader's state should be saved in the <code>ExecutionContext</code> provided by <code>ItemStream#update(ExecutionContext)</code> The default value is false.
driverSupportsAbsolute	Defaults to false. Indicates whether the Jdbc driver supports setting the absolute row on a <code>ResultSet</code> . It is recommended that this is set to true for Jdbc drivers that supports <code>ResultSet.absolute()</code> as it may improve performance, especially if a step fails while working with a large data set.
setUseSharedExtendedConnection	Defaults to false. Indicates whether the connection used for the cursor should be used by all other processing thus sharing the same transaction. If this is set to false, which is the default, then the cursor will be opened using its own connection and will not participate in any transactions started for the rest of the step processing. If you set this flag to true then you must wrap the <code>DataSource</code> in an <code>ExtendedConnectionDataSourceProxy</code> to prevent the connection from being closed and released after each commit. When you set this option to true then the statement used to open the cursor will be created with both 'READ_ONLY' and 'HOLD_CUSORS_OVER_COMMIT' options. This allows holding the cursor open over transaction start and commits performed in the step processing. To use this feature you need a database that supports this and a Jdbc driver supporting Jdbc 3.0 or later.

6.9.1.2. HibernateCursorItemReader

Just as normal Spring users make important decisions about whether or not to use ORM solutions, which affect whether or not they use a `JdbcTemplate` or a `HibernateTemplate`, Spring Batch users have the same options. `HibernateCursorItemReader` is the Hibernate implementation of the cursor technique. Hibernate's usage in batch has been fairly controversial. This has largely been because Hibernate was originally developed to support online application styles. However, that doesn't mean it can't be used for batch processing. The easiest approach for solving this problem is to use a `StatelessSession` rather than a standard session. This removes all of the caching and dirty checking hibernate employs that can cause issues in a batch scenario. For more information on the differences between stateless and normal hibernate sessions, refer to the documentation of your specific hibernate release. The `HibernateCursorItemReader` allows you to declare an HQL statement and pass in a `SessionFactory`, which will pass back one item per call to `read` in the same basic fashion as the `JdbcCursorItemReader`. Below is an example configuration using the same 'customer credit' example as the JDBC reader:

```

HibernateCursorItemReader itemReader = new HibernateCursorItemReader();
itemReader.setQueryString("from CustomerCredit");
//For simplicity sake, assume sessionFactory already obtained.
itemReader.setSessionFactory(sessionFactory);
itemReader.setUseStatelessSession(true);
int counter = 0;
ExecutionContext executionContext = new ExecutionContext();
itemReader.open(executionContext);
Object customerCredit = new Object();
while(customerCredit != null){
    customerCredit = itemReader.read();
    counter++;
}
itemReader.close(executionContext);

```

This configured `ItemReader` will return `CustomerCredit` objects in the exact same manner as described by the `JdbcCursorItemReader`, assuming hibernate mapping files have been created correctly for the `Customer` table. The 'useStatelessSession' property defaults to true, but has been added here to draw attention to the ability to switch it on or off. It is also worth noting that the `fetchSize` of the underlying cursor can be set via the `setFetchSize` property. As with `JdbcCursorItemReader`, configuration is straightforward:

```

<bean id="itemReader"
      class="org.springframework.batch.item.database.HibernateCursorItemReader">
    <property name="sessionFactory" ref="sessionFactory" />
    <property name="queryString" value="from CustomerCredit" />
</bean>

```

6.9.2. Paging ItemReaders

An alternative to using a database cursor is executing multiple queries where each query is bringing back a portion of the results. We refer to this portion as a page. Each query that is executed must specify the starting row number and the number of rows that we want returned for the page.

6.9.2.1. JdbcPagingItemReader

One implementation of a paging `ItemReader` is the `JdbcPagingItemReader`. The `JdbcPagingItemReader` needs a `PagingQueryProvider` responsible for providing the SQL queries used to retrieve the rows making up a page. Since each database has its own strategy for providing paging support, we need to use a different `PagingQueryProvider` for each supported database type.

There is also the `SqlPagingQueryProviderFactoryBean` that will auto-detect the database that is being used and determine the appropriate `PagingQueryProvider` implementation. This simplifies the configuration and is the recommended best practice.

The `SqlPagingQueryProviderFactoryBean` requires that you specify a select clause and a from clause. You can also provide an optional where clause. These clauses will be used to build an SQL statement combined with the required `sortKey`.

After the reader has been opened, it will pass back one item per call to `read` in the same basic fashion as any other `ItemReader`. The paging happens behind the scenes when additional rows are needed.

Below is an example configuration using a similar 'customer credit' example as the cursor based `ItemReaders` above:

```
<bean id="itemReader" class="org.spr...JdbcPagingItemReader">
  <property name="dataSource" ref="dataSource"/>
  <property name="queryProvider">
    <bean class="org.spr...SqlPagingQueryProviderFactoryBean">
      <property name="selectClause" value="select id, name, credit"/>
      <property name="fromClause" value="from customer"/>
      <property name="whereClause" value="where status=:status"/>
      <property name="sortKey" value="id"/>
    </bean>
  </property>
  <property name="parameterValues">
    <map>
      <entry key="status" value="NEW"/>
    </map>
  </property>
  <property name="pageSize" value="1000"/>
  <property name="rowMapper" ref="customerMapper"/>
</bean>
```

This configured `ItemReader` will return `CustomerCredit` objects using the `RowMapper` that must be specified. The 'pageSize' property determines the number of entities read from the database for each query execution.

The 'parameterValues' property can be used to specify a `Map` of parameter values for the query. If you use named parameters in the where clause the key for each entry should match the name of the named parameter. If you use a traditional '?' placeholder then the key for each entry should be the number of the placeholder, starting with 1.

6.9.2.2. JpaPagingItemReader

Another implementation of a paging `ItemReader` is the `JpaPagingItemReader`. JPA doesn't have a concept similar to the Hibernate `StatelessSession` so we have to use other features provided by the JPA specification. Since JPA supports paging, this is a natural choice when it comes to using JPA for batch processing. After each page is read, the entities will become detached and the persistence context will be cleared in order to allow the entities to be garbage collected once the page is processed.

The `JpaPagingItemReader` allows you to declare a JPQL statement and pass in a `EntityManagerFactory`. It will then pass back one item per call to `read` in the same basic fashion as any other `ItemReader`. The paging happens behind the scenes when additional entities are needed. Below is an example configuration using the same 'customer credit' example as the JDBC reader above:

```
<bean id="itemReader" class="org.spr...JpaPagingItemReader">
```

```

<property name="entityManagerFactory" ref="entityManagerFactory"/>
<property name="queryString" value="select c from CustomerCredit c"/>
<property name="pageSize" value="1000"/>
</bean>

```

This configured `ItemReader` will return `CustomerCredit` objects in the exact same manner as described by the `JdbcPagingItemReader` above, assuming the `Customer` object has the correct JPA annotations or ORM mapping file. The 'pageSize' property determines the number of entities read from the database for each query execution.

6.9.2.3. IbatisPagingItemReader

If you use IBATIS for your data access then you can use the `IbatisPagingItemReader` which, as the name indicates, is an implementation of a paging `ItemReader`. IBATIS doesn't have direct support for reading rows in pages but by providing a couple of standard variables you can add paging support to your IBATIS queries.

Here is an example of a configuration for a `IbatisPagingItemReader` reading `CustomerCredits` as in the examples above:

```

<bean id="itemReader" class="org.spr...IbatisPagingItemReader">
  <property name="sqlMapClient" ref="sqlMapClient"/>
  <property name="queryId" value="getPagedCustomerCredits"/>
  <property name="pageSize" value="1000"/>
</bean>

```

The `IbatisPagingItemReader` configuration above references an IBATIS query called "getPagedCustomerCredits". Here is an example of what that query should look like for MySQL.

```

<select id="getPagedCustomerCredits" resultMap="customerCreditResult">
  select id, name, credit from customer order by id asc LIMIT #_skiprows#, #_pagesize#
</select>

```

The `_skiprows` and `_pagesize` variables are provided by the `IbatisPagingItemReader` and there is also a `_page` variable that can be used if necessary. The syntax for the paging queries varies with the database used. Here is an example for Oracle (unfortunately we need to use CDATA for some operators since this belongs in an XML document):

```

<select id="getPagedCustomerCredits" resultMap="customerCreditResult">
  select * from (
    select * from (
      select t.id, t.name, t.credit, ROWNUM ROWNUM_ from customer t order by id
    ) where ROWNUM_ <![CDATA[ > ]]> ( #_page# * #_pagesize# )
  ) where ROWNUM <![CDATA[ <= ]]> #_pagesize#
</select>

```

6.9.3. Database ItemWriters

While both Flat Files and XML have specific `ItemWriters`, there is no exact equivalent in the database world. This is because transactions provide all the functionality that is needed. `ItemWriters` are necessary for files because they must act as if they're transactional, keeping track of written items and flushing or clearing at the appropriate times. Databases have no need for this functionality, since the write is already contained in a transaction. Users can create their own DAOs that implement the `ItemWriter` interface or use one from a custom `ItemWriter` that's written for generic processing concerns, either way, they should work without any issues. One thing to look out for is the performance

and error handling capabilities that are provided by batching the outputs. This is most common when using hibernate as an `ItemWriter`, but could have the same issues when using Jdbc batch mode. Batching database output doesn't have any inherent flaws, assuming we are careful to flush and there are no errors in the data. However, any errors while writing out can cause confusion because there is no way to know which individual item caused an exception, or even if any individual item was responsible, as illustrated below:

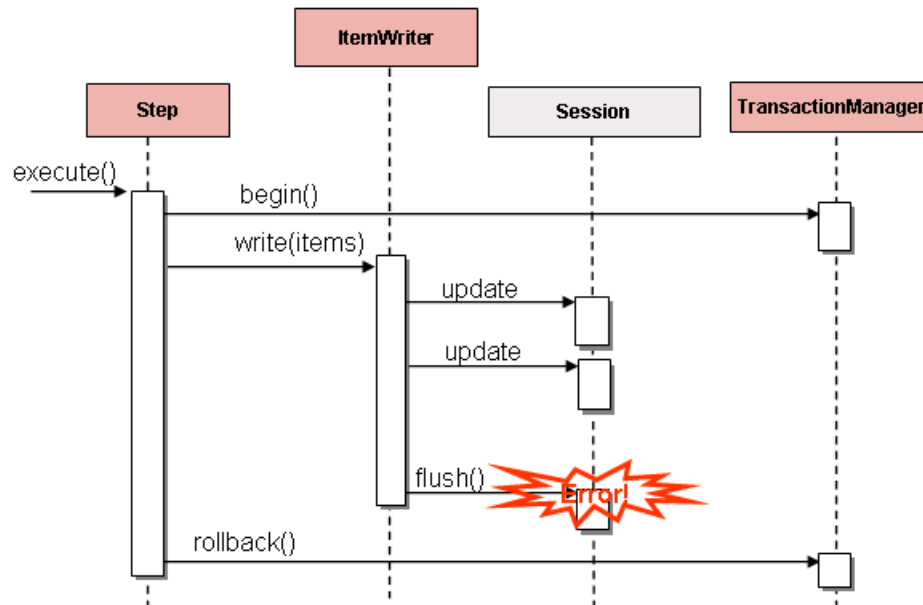

If items are buffered before being written out, any errors encountered will not be thrown until the buffer is flushed just before a commit. For example, let's assume that 20 items will be written per chunk, and the 15th item throws a `DataIntegrityViolationException`. As far as the `Step` is concerned, all 20 items will be written out successfully, since there's no way to know that an error will occur until they are actually written out. Once `Session#flush()` is called, the buffer will be emptied and the exception will be hit. At this point, there's nothing the `Step` can do, the transaction must be rolled back. Normally, this exception might cause the `Item` to be skipped (depending upon the skip/retry policies), and then it won't be written out again. However, in the batched scenario, there's no way for it to know which item caused the issue, the whole buffer was being written out when the failure happened. The only way to solve this issue is to flush after each item:

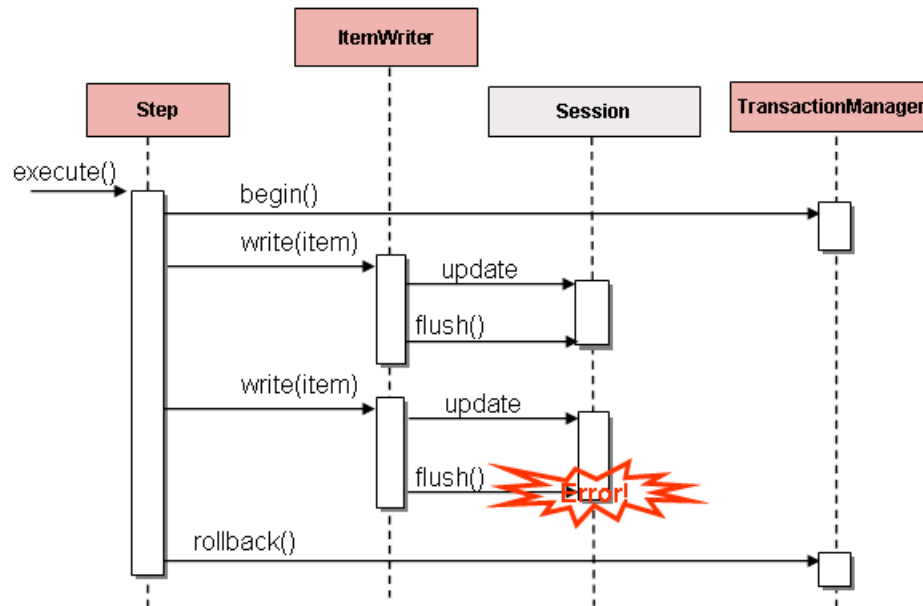

This is a common use case, especially when using Hibernate, and the simple guideline for implementations of `ItemWriter`, is to flush on each call to `write()`. Doing so allows for items to be skipped reliably, with Spring Batch taking care internally of the granularity of the calls to `ItemWriter` after an error.

6.10. Reusing Existing Services

Batch systems are often used in conjunction with other application styles. The most common is an online system, but it may also support integration or even a thick client application by moving necessary bulk data that each application style uses. For this reason, it is common that many users want to reuse existing DAOs or other services within their batch jobs. The Spring container itself makes this fairly easy by allowing any necessary class to be injected. However, there may be cases where the existing service needs to act as an `ItemReader` or `ItemWriter`, either to satisfy the dependency of another Spring Batch class, or because it truly is the main `ItemReader` for a step. It is fairly trivial to write an adaptor class for each service that needs wrapping, but because it is such a common concern, Spring Batch provides implementations: `ItemReaderAdapter` and `ItemWriterAdapter`. Both classes implement the standard Spring method invoking the delegate pattern and are fairly simple to set up. Below is an example of the reader:

```

<bean id="itemReader" class="org.springframework.batch.item.adapter.ItemReaderAdapter">
  <property name="targetObject" ref="fooService" />
  <property name="targetMethod" value="generateFoo" />
</bean>

<bean id="fooService" class="org.springframework.batch.item.sample.FooService" />
  
```

One important point to note is that the contract of the `targetMethod` must be the same as the contract for `read`: when exhausted it will return null, otherwise an `Object`. Anything else will prevent the framework from knowing when processing should end, either causing an infinite loop or incorrect failure, depending upon the implementation of the `ItemWriter`. The `ItemWriter` implementation is equally as simple:

```

<bean id="itemWriter" class="org.springframework.batch.item.adapter.ItemWriterAdapter">
  <property name="targetObject" ref="fooService" />
  <property name="targetMethod" value="processFoo" />
</bean>

<bean id="fooService" class="org.springframework.batch.item.sample.FooService" />

```

6.11. Validating Input

During the course of this chapter, multiple approaches to parsing input have been discussed. Each major implementation will throw an exception if it is not 'well-formed'. The `FixedLengthTokenizer` will throw an exception if a range of data is missing. Similarly, attempting to access an index in a `RowMapper` or `FieldSetMapper` that doesn't exist or is in a different format than the one expected will cause an exception to be thrown. All of these types of exceptions will be thrown before `read` returns. However, they don't address the issue of whether or not the returned item is valid. For example, if one of the fields is an age, it obviously cannot be negative. It will parse correctly, because it existed and is a number, but it won't cause an exception. Since there are already a plethora of Validation frameworks, Spring Batch does not attempt to provide yet another, but rather provides a very simple interface that can be implemented by any number of frameworks:

```

public interface Validator {

    void validate(Object value) throws ValidationException;

}

```

The contract is that the `validate` method will throw an exception if the object is invalid, and return normally if it is valid. Spring Batch provides an out of the box `ItemProcessor`:

```

<bean class="org.springframework.batch.item.validator.ValidatorItemProcessor">
  <property name="validator" ref="validator" />
</bean>

<bean id="validator"
  class="org.springframework.batch.item.validator.SpringValidator">
  <property name="validator">
    <bean id="orderValidator"
      class="org.springframework.validation.valang.ValangValidator">
      <property name="valang">
        <value>
          <![CDATA[
{ orderId : ? > 0 AND ? <= 9999999999 : 'Incorrect order ID' : 'error.order.id' }
{ totalLines : ? = size(lineItems) : 'Bad count of order lines'
  : 'error.order.lines.badcount' }
{ customer.registered : customer.businessCustomer = FALSE OR ? = TRUE
  : 'Business customer must be registered'
  : 'error.customer.registration' }
{ customer.companyName : customer.businessCustomer = FALSE OR ? HAS TEXT
  : 'Company name for business customer is mandatory'
  : 'error.customer.companyname' }

]]>
        </value>
      </property>
    </bean>
  </property>
</bean>

```

This simple example shows a simple `ValangValidator` that is used to validate an order object. The intent is not to show Valang functionality as much as to show how a validator could be added.

6.12. Preventing State Persistence

By default, all of the `ItemReader` and `ItemWriter` implementations store their current state in the `ExecutionContext` before it is committed. However, this may not always be the desired behavior. For example, many developers choose to make their database readers 'rerunnable' by using a process indicator. An extra column is added to the input data to indicate whether or not it has been processed. When a particular record is being read (or written out) the processed flag is flipped from false to true. The SQL statement can then contain an extra statement in the where clause, such as "where PROCESSED_IND = false", thereby ensuring that only unprocessed records will be returned in the case of a restart. In this scenario, it is preferable to not store any state, such as the current row number, since it will be irrelevant upon restart. For this reason, all readers and writers include the 'saveState' property:

```
<bean id="playerSummarizationSource" class="org.spr...JdbcCursorItemReader">
  <property name="dataSource" ref="dataSource" />
  <property name="rowMapper">
    <bean class="org.springframework.batch.sample.PlayerSummaryMapper" />
  </property>
  <property name="saveState" value="false" />
  <property name="sql">
    <value>
      SELECT games.player_id, games.year_no, SUM(COMPLETES),
      SUM(ATTEMPTS), SUM(PASSING_YARDS), SUM(PASSING_TD),
      SUM(INTERCEPTIONS), SUM(RUSHES), SUM(RUSH_YARDS),
      SUM(RECEPTIONS), SUM(RECEPTIONS_YARDS), SUM(TOTAL_TD)
      from games, players where players.player_id =
      games.player_id group by games.player_id, games.year_no
    </value>
  </property>
</bean>
```

The `ItemReader` configured above will not make any entries in the `ExecutionContext` for any executions in which it participates.

6.13. Creating Custom ItemReaders and ItemWriters

So far in this chapter the basic contracts that exist for reading and writing in Spring Batch and some common implementations have been discussed. However, these are all fairly generic, and there are many potential scenarios that may not be covered by out of the box implementations. This section will show, using a simple example, how to create a custom `ItemReader` and `ItemWriter` implementation and implement their contracts correctly. The `ItemReader` will also implement `ItemStream`, in order to illustrate how to make a reader or writer restartable.

6.13.1. Custom ItemReader Example

For the purpose of this example, a simple `ItemReader` implementation that reads from a provided list will be created. We'll start out by implementing the most basic contract of `ItemReader`, `read`:

```
public class CustomItemReader<T> implements ItemReader<T>{

    List<T> items;

    public CustomItemReader(List<T> items) {
        this.items = items;
    }

    public T read() throws Exception, UnexpectedInputException,
```

```

    NoWorkFoundException, ParseException {

        if (!items.isEmpty()) {
            return items.remove(0);
        }
        return null;
    }
}

```

This very simple class takes a list of items, and returns them one at a time, removing each from the list. When the list is empty, it returns null, thus satisfying the most basic requirements of an `ItemReader`, as illustrated below:

```

List<String> items = new ArrayList<String>();
items.add("1");
items.add("2");
items.add("3");

ItemReader itemReader = new CustomItemReader<String>(items);
assertEquals("1", itemReader.read());
assertEquals("2", itemReader.read());
assertEquals("3", itemReader.read());
assertNull(itemReader.read());

```

6.13.1.1. Making the `ItemReader` Restartable

The final challenge now is to make the `ItemReader` restartable. Currently, if the power goes out, and processing begins again, the `ItemReader` must start at the beginning. This is actually valid in many scenarios, but it is sometimes preferable that a batch job starts where it left off. The key discriminant is often whether the reader is stateful or stateless. A stateless reader does not need to worry about restartability, but a stateful one has to try and reconstitute its last known state on restart. For this reason, we recommend that you keep custom readers stateless if possible, so you don't have to worry about restartability.

If you do need to store state, then the `ItemStream` interface should be used:

```

public class CustomItemReader<T> implements ItemReader<T>, ItemStream {

    List<T> items;
    int currentIndex = 0;
    private static final String CURRENT_INDEX = "current.index";

    public CustomItemReader(List<T> items) {
        this.items = items;
    }

    public T read() throws Exception, UnexpectedInputException,
        ParseException {

        if (currentIndex < items.size()) {
            return items.get(currentIndex++);
        }

        return null;
    }

    public void open(ExecutionContext executionContext) throws ItemStreamException {
        if(executionContext.containsKey(CURRENT_INDEX)){
            currentIndex = new Long(executionContext.getLong(CURRENT_INDEX)).intValue();
        }
        else{
            currentIndex = 0;
        }
    }
}

```

```

    }
}

public void update(ExecutionContext executionContext) throws ItemStreamException {
    executionContext.putLong(CURRENT_INDEX, new Long(currentIndex).longValue());
}

public void close() throws ItemStreamException {}
}

```

On each call to the `ItemStream` `update` method, the current index of the `ItemReader` will be stored in the provided `ExecutionContext` with a key of 'current.index'. When the `ItemStream` `open` method is called, the `ExecutionContext` is checked to see if it contains an entry with that key. If the key is found, then the current index is moved to that location. This is a fairly trivial example, but it still meets the general contract:

```

ExecutionContext executionContext = new ExecutionContext();
((ItemStream)itemReader).open(executionContext);
assertEquals("1", itemReader.read());
((ItemStream)itemReader).update(executionContext);

List<String> items = new ArrayList<String>();
items.add("1");
items.add("2");
items.add("3");
itemReader = new CustomItemReader<String>(items);

((ItemStream)itemReader).open(executionContext);
assertEquals("2", itemReader.read());

```

Most `ItemReaders` have much more sophisticated restart logic. The `JdbcCursorItemReader`, for example, stores the row id of the last processed row in the `Cursor`.

It is also worth noting that the key used within the `ExecutionContext` should not be trivial. That is because the same `ExecutionContext` is used for all `ItemStreams` within a `Step`. In most cases, simply prepending the key with the class name should be enough to guarantee uniqueness. However, in the rare cases where two of the same type of `ItemStream` are used in the same step (which can happen if two files are need for output) then a more unique name will be needed. For this reason, many of the Spring Batch `ItemReader` and `ItemWriter` implementations have a `setName()` property that allows this key name to be overridden.

6.13.2. Custom ItemWriter Example

Implementing a Custom `ItemWriter` is similar in many ways to the `ItemReader` example above, but differs in enough ways as to warrant its own example. However, adding restartability is essentially the same, so it won't be covered in this example. As with the `ItemReader` example, a `List` will be used in order to keep the example as simple as possible:

```

public class CustomItemWriter<T> implements ItemWriter<T> {

    List<T> output = TransactionAwareProxyFactory.createTransactionalList();

    public void write(List<? extends T> items) throws Exception {
        output.addAll(items);
    }

    public List<T> getOutput() {
        return output;
    }
}

```

```
}
```

6.13.2.1. Making the `ItemWriter` Restartable

To make the `ItemWriter` restartable we would follow the same process as for the `ItemReader`, adding and implementing the `ItemStream` interface to synchronize the execution context. In the example we might have to count the number of items processed and add that as a footer record. If we needed to do that, we could implement `ItemStream` in our `ItemWriter` so that the counter was reconstituted from the execution context if the stream was re-opened.

In many realistic cases, custom `ItemWriters` also delegate to another writer that itself is restartable (e.g. when writing to a file), or else it writes to a transactional resource so doesn't need to be restartable because it is stateless. When you have a stateful writer you should probably also be sure to implement `ItemStream` as well as `ItemWriter`. Remember also that the client of the writer needs to be aware of the `ItemStream`, so you may need to register it as a stream in the configuration xml.

Chapter 7. Scaling and Parallel Processing

Many batch processing problems can be solved with single threaded, single process jobs, so it is always a good idea to properly check if that meets your needs before thinking about more complex implementations. Measure the performance of a realistic job and see if the simplest implementation meets your needs first: you can read and write a file of several hundred megabytes in well under a minute, even with bog standard hardware.

When you are ready to start implementing a job with some parallel processing, Spring Batch offers a range of options, which are described in this chapter, although some features are covered elsewhere. At a high level there are two modes of parallel processing: single process, multi-threaded; and multi-process. These break down into categories as well, as follows:

- Multi-threaded Step (single process)
- Parallel Steps (single process)
- Remote Chunking of Step (multi process)
- Partitioning a Step (single or multi process)

Next we review the single-process options first, and then the multi-process options.

7.1. Multi-threaded Step

The simplest way to start parallel processing is to add a `TaskExecutor` to your Step configuration, e.g. as an attribute of the `chunk`:

```
<step id="loading">
  <tasklet>
    <chunk reader="stagingReader"
           processor="stagingProcessor"
           writer="tradeWriter"
           commit-interval="1"
           task-executor="taskExecutor" />
  </tasklet>
</step>
```

In this example the `taskExecutor` is a reference to another bean definition, implementing the `TaskExecutor` interface. `TaskExecutor` is a standard Spring interface, so consult the Spring User Guide for details of available implementations. The simplest multi-threaded `TaskExecutor` is a `SimpleAsyncTaskExecutor`.

The result of the above configuration will be that the Step executes by reading, processing and writing each chunk of items (each commit interval) in a separate thread of execution.

There are some practical limitations of using multi-threaded Steps for some common Batch use cases. Many participants in a Step (e.g. readers and writers) are stateful, and if the state is not segregated by thread, then those components are not usable in a multi-threaded Step. In particular most of the off-the-shelf readers and writers from Spring Batch are not designed for multi-threaded use. It is, however, possible to work with stateless or thread safe readers and writers, and there is a sample (`parallelJob`) in the Spring Batch Samples that show the use of a process indicator (see Section 6.12,

“Preventing State Persistence”) to keep track of items that have been processed in a database input table.

7.2. Parallel Steps

As long as the application logic that needs to be parallelized can be split into distinct responsibilities, and assigned to individual steps then it can be parallelized in a single process. Parallel Step execution is easy to configure and use, for example, to execute steps (`step1`, `step2`) in parallel with `step3`, you could configure a flow like this:

```
<job id="job1">
  <split id="split1" task-executor="taskExecutor" next="step4">
    <flow>
      <step id="step1" parent="s1" next="step2"/>
      <step id="step2" parent="s2"/>
    </flow>
    <flow>
      <step id="step3" parent="s3"/>
    </flow>
  </split>
  <step id="step4" parent="s4"/>
</job>

<beans:bean id="taskExecutor" class="org.spr...SimpleAsyncTaskExecutor"/>
```

The configurable "task-executor" attribute is used to specify which `TaskExecutor` implementation should be used to execute the individual flows. The default is `SyncTaskExecutor`, but an asynchronous `TaskExecutor` is required to run the steps in parallel. Note that the job will ensure that every flow in the split completes before aggregating the exit statuses and transitioning.

See the section on Section 5.3.5, “Split Flows” for more detail.

7.3. Remote Chunking

In Remote Chunking the Step processing is split across multiple processes, communicating with each other through some middleware. Here is a picture of the pattern in action:

Remote Chunking

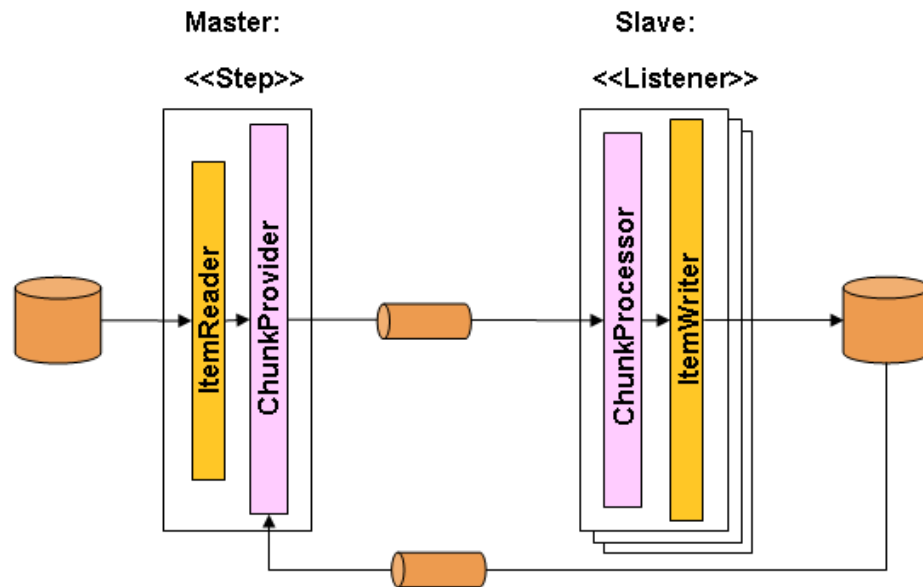

The Master component is a single process, and the Slaves are multiple remote processes. Clearly this pattern works best if the Master is not a bottleneck, so the processing must be more expensive than the reading of items (this is often the case in practice).

The Master is just an implementation of a Spring Batch `Step`, with the `ItemWriter` replaced with a generic version that knows how to send chunks of items to the middleware as messages. The Slaves are standard listeners for whatever middleware is being used (e.g. with JMS they would be `MessageListeners`), and their role is to process the chunks of items using a standard `ItemWriter` or `ItemProcessor` plus `ItemWriter`, through the `ChunkProcessor` interface. One of the advantages of using this pattern is that the reader, processor and writer components are off-the-shelf (the same as would be used for a local execution of the step). The items are divided up dynamically and work is shared through the middleware, so if the listeners are all eager consumers, then load balancing is automatic.

The middleware has to be durable, with guaranteed delivery and single consumer for each message. JMS is the obvious candidate, but other options exist in the grid computing and shared memory product space (e.g. Java Spaces).

Spring Batch has a sub-project (Spring Batch Integration), providing implementations of various patterns like this one using Spring Integration. Spring Batch Integration is available in subversion for people to use, but is not intended to be part of the official general release of Spring Batch until it builds up more of a community of users.

7.4. Partitioning

Spring Batch also provides an SPI for partitioning a Step execution and executing it remotely. In this case the remote participants are simply Step instances that could just as easily have been configured and used for local processing. Here is a picture of the pattern in action:

Partitioning Overview

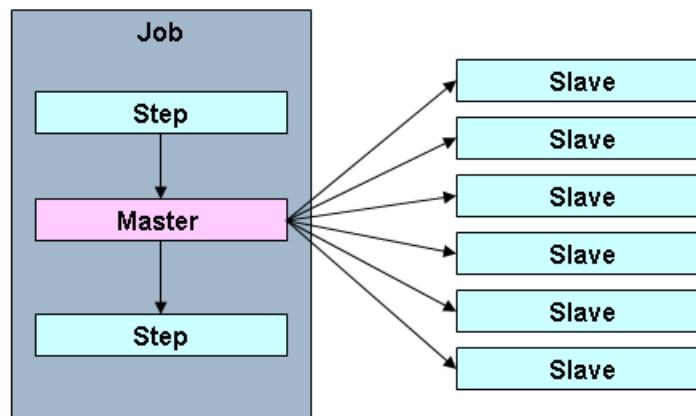

The Job is executing on the left hand side as a sequence of Steps, and one of the Steps is labelled as a Master. The Slaves in this picture are all identical instances of a Step, which could in fact take the place of the Master resulting in the same outcome for the Job. The Slaves are typically going to be remote services, but could also be local threads of execution. The messages sent by the Master to the Slaves in this pattern do not need to be durable, or have guaranteed delivery: Spring Batch meta-data in the `JobRepository` will ensure that each Slave is executed once and only once for each Job execution.

The SPI in Spring Batch consists of a special implementation of Step (the `PartitionStep`), and two strategy interfaces that need to be implemented for the specific environment. The strategy interfaces are `PartitionHandler` and `StepExecutionSplitter`, and their role is show in the sequence diagram below:

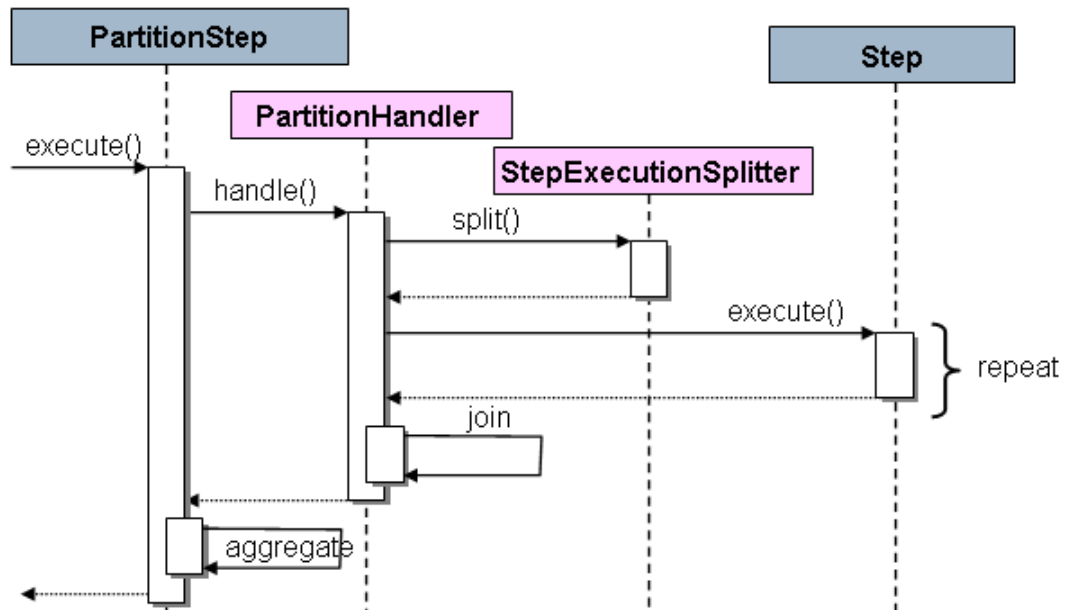

The Step on the right in this case is the "remote" Slave, so potentially there are many objects and or processes playing this role, and the PartitionStep is shown driving the execution. The PartitionStep configuration looks like this:

```

<bean name="step1:master" class="org.sfw...PartitionStep">
  <property name="partitionHandler" ref="partitionHandler"/>
  <property name="stepExecutionSplitter" ref="stepExecutionSplitter"/>
  <property name="jobRepository" ref="jobRepository" />
</bean>

```

There is a simple example which can be copied and extended in the unit test suite for Spring Batch Core (see `org.springframework.batch.core.partition` package).

7.4.1. PartitionHandler

The `PartitionHandler` is the component that knows about the fabric of the remoting or grid environment. It is able to send `StepExecution` requests to the remote Steps, wrapped in some fabric-specific format, like a DTO. It does not have to know how to split up the input data, or how to aggregate the result of multiple Step executions. Generally speaking it probably also doesn't need to know about resilience or failover, since those are features of the fabric in many cases, and anyway Spring Batch always provides restartability independent of the fabric: a failed Job can always be restarted and only the failed Steps will be re-executed.

The `PartitionHandler` interface can have specialized implementations for a variety of fabric types: e.g. simple RMI remoting, EJB remoting, custom web service, JMS, Java Spaces, shared memory grids (like Terracotta or Coherence), grid execution fabrics (like GridGain). Spring Batch does not contain implementations for any proprietary grid or remoting fabrics.

Spring Batch does however provide a useful implementation of `PartitionHandler` that executes Steps locally in separate threads of execution, using the `TaskExecutor` strategy from Spring. The implementation is called `TaskExecutorPartitionHandler`, and it can be configured like this:

```
<bean class="org.spr...TaskExecutorPartitionHandler">
  <property name="taskExecutor" ref="taskExecutor"/>
  <property name="step" ref="step1" />
  <property name="gridSize" value="10" />
</bean>
```

The `gridSize` determines the number of separate step executions to create, so it can be matched to the size of the thread pool in the `TaskExecutor`, or else it can be set to be larger than the number of threads available, in which case the blocks of work are smaller.

The `TaskExecutorPartitionHandler` is quite useful for IO intensive Steps, like copying large numbers of files or replicating filesystems into content management systems.

7.4.2. StepExecutionSplitter

The `StepExecutionSplitter` is responsible for splitting up a `StepExecution` into blocks of work, and providing input parameters for the remote Slaves in the form of an `ExecutionContext` for each one. The principal method for this in the interface is

```
public interface StepExecutionSplitter {
  ...
  Set<StepExecution> split(StepExecution stepExecution, int gridSize)
    throws JobExecutionException;
}
```

So an execution instance for the Master step is passed in, along with a hint about the grid size, and the splitter has to create a set of partitioned `StepExecution` instances, each with a different `ExecutionContext`.

A convenient generic implementation of `StepExecutionSplitter` is provided by Spring Batch, which handles concerns like interpreting the grid size and handling restart. It is recommended that you use this implementation (the `SimpleStepExecutionSplitter`) and inject specific knowledge of the input data through its `Partitioner` property. The `Partitioner` has a simpler responsibility: to generate execution contexts as input parameters for new step executions only (no need to worry about restarts). It has a single method:

```
public interface Partitioner {
  Map<String, ExecutionContext> partition(int gridSize);
}
```

The return value from this method associates a unique name for each step execution (the `String`), with input parameters in the form of an `ExecutionContext`. The names show up later in the Batch meta data as the step name in the partitioned `StepExecutions`. The `ExecutionContext` is just a bag of name-value pairs, so it might contain a range of primary keys, or line numbers, or the location of an input file. The remote `Step` then normally binds to the context input using `#{...}` placeholders (late binding in step scope), as illustrated in the next section.

The names of the step executions (the keys in the `Map` returned by `Partitioner`) need to be unique amongst the step executions of a Job, but do not have any other specific requirements. The easiest way to do this, and to make the names meaningful for users, is to use a prefix+suffix naming convention,

where the prefix is the name of the step that is being executed (which itself is unique in the `Job`), and the suffix is just a counter. There is a `SimplePartitioner` in the framework that uses this convention.

7.4.3. Binding Input Data to Steps

It is very efficient for the steps that are executed by the `PartitionHandler` to have identical configuration, and for their input parameters to be bound at runtime from the `ExecutionContext`. This is easy to do with the `StepScope` feature of Spring Batch (covered in more detail in the section on Late Binding). For example if the `Partitioner` creates `ExecutionContext` instances with an attribute key `fileName`, pointing to a different file (or directory) for each step invocation, the `Partitioner` output might look like this:

Table 7.1. Example step execution name to execution context provided by `Partitioner` targeting directory processing

Step Execution Name (key)	ExecutionContext (value)
filecopy:partition0	fileName=/home/data/one
filecopy:partition1	fileName=/home/data/two
filecopy:partition2	fileName=/home/data/three

Then the file name can be bound to a step using late binding to the execution context:

```
<bean id="itemReader" scope="step"
      class="org.spr...MultiResourceItemReader">
  <property name="resource" value="#{stepExecutionContext[fileName]}/*"/>
</bean>
```

Chapter 8. Repeat

8.1. RepeatTemplate

Batch processing is about repetitive actions - either as a simple optimization, or as part of a job. To strategize and generalize the repetition as well as to provide what amounts to an iterator framework, Spring Batch has the `RepeatOperations` interface. The `RepeatOperations` interface looks like this:

```
public interface RepeatOperations {  
  
    RepeatStatus iterate(RepeatCallback callback) throws RepeatException;  
  
}
```

The callback is a simple interface that allows you to insert some business logic to be repeated:

```
public interface RepeatCallback {  
  
    RepeatStatus doInIteration(RepeatContext context) throws Exception;  
  
}
```

The callback is executed repeatedly until the implementation decides that the iteration should end. The return value in these interfaces is an enumeration that can either be `RepeatStatus.CONTINUABLE` or `RepeatStatus.FINISHED`. A `RepeatStatus` conveys information to the caller of the repeat operations about whether there is any more work to do. Generally speaking, implementations of `RepeatOperations` should inspect the `RepeatStatus` and use it as part of the decision to end the iteration. Any callback that wishes to signal to the caller that there is no more work to do can return `RepeatStatus.FINISHED`.

The simplest general purpose implementation of `RepeatOperations` is `RepeatTemplate`. It could be used like this:

```
RepeatTemplate template = new RepeatTemplate();  
  
template.setCompletionPolicy(new FixedChunkSizeCompletionPolicy(2));  
  
template.iterate(new RepeatCallback() {  
  
    public ExitStatus doInIteration(RepeatContext context) {  
        // Do stuff in batch...  
        return ExitStatus.CONTINUABLE;  
    }  
  
});
```

In the example we return `RepeatStatus.CONTINUABLE` to show that there is more work to do. The callback can also return `ExitStatus.FINISHED` if it wants to signal to the caller that there is no more work to do. Some iterations can be terminated by considerations intrinsic to the work being done in the callback, others are effectively infinite loops as far as the callback is concerned and the completion decision is delegated to an external policy as in the case above.

8.1.1. RepeatContext

The method parameter for the `RepeatCallback` is a `RepeatContext`. Many callbacks will simply ignore the context, but if necessary it can be used as an attribute bag to store transient data for the duration of the iteration. After the `iterate` method returns, the context will no longer exist.

A `RepeatContext` will have a parent context if there is a nested iteration in progress. The parent context is occasionally useful for storing data that need to be shared between calls to `iterate`. This is the case for instance if you want to count the number of occurrences of an event in the iteration and remember it across subsequent calls.

8.1.2. RepeatStatus

`RepeatStatus` is an enumeration used by Spring Batch to indicate whether processing has finished. These are possible `RepeatStatus` values:

Table 8.1. ExitStatus Properties

Value	Description
CONTINUABLE	There is more work to do.
FINISHED	No more repetitions should take place.

`RepeatStatus` values can also be combined with a logical AND operation using the `and()` method in `RepeatStatus`. The effect of this is to do a logical AND on the continuable flag. In other words, if either status is `FINISHED`, then the result will be `FINISHED`.

8.2. Completion Policies

Inside a `RepeatTemplate` the termination of the loop in the `iterate` method is determined by a `CompletionPolicy` which is also a factory for the `RepeatContext`. The `RepeatTemplate` has the responsibility to use the current policy to create a `RepeatContext` and pass that in to the `RepeatCallback` at every stage in the iteration. After a callback completes its `doInIteration`, the `RepeatTemplate` has to make a call to the `CompletionPolicy` to ask it to update its state (which will be stored in the `RepeatContext`). Then it asks the policy if the iteration is complete.

Spring Batch provides some simple general purpose implementations of `CompletionPolicy`. The `SimpleCompletionPolicy` just allows an execution up to a fixed number of times (with `RepeatStatus.FINISHED` forcing early completion at any time).

Users might need to implement their own completion policies for more complicated decisions. For example, a batch processing window that prevents batch jobs from executing once the online systems are in use would require a custom policy.

8.3. Exception Handling

If there is an exception thrown inside a `RepeatCallback`, the `RepeatTemplate` consults an `ExceptionHandler` which can decide whether or not to re-throw the exception.

```
public interface ExceptionHandler {
    void handleException(RepeatContext context, Throwable throwable)
```

```
throws RuntimeException;

}
```

A common use case is to count the number of exceptions of a given type, and fail when a limit is reached. For this purpose Spring Batch provides the `SimpleLimitExceptionHandler` and slightly more flexible `RethrowOnThresholdExceptionHandler`. The `SimpleLimitExceptionHandler` has a `limit` property and an exception type that should be compared with the current exception - all subclasses of the provided type are also counted. Exceptions of the given type are ignored until the limit is reached, and then rethrown. Those of other types are always rethrown.

An important optional property of the `SimpleLimitExceptionHandler` is the boolean flag `useParent`. It is false by default, so the limit is only accounted for in the current `RepeatContext`. When set to true, the limit is kept across sibling contexts in a nested iteration (e.g. a set of chunks inside a step).

8.4. Listeners

Often it is useful to be able to receive additional callbacks for cross cutting concerns across a number of different iterations. For this purpose Spring Batch provides the `RepeatListener` interface. The `RepeatTemplate` allows users to register `RepeatListeners`, and they will be given callbacks with the `RepeatContext` and `RepeatStatus` where available during the iteration.

The interface looks like this:

```
public interface RepeatListener {
    void before(RepeatContext context);

    void after(RepeatContext context, RepeatStatus result);

    void open(RepeatContext context);

    void onError(RepeatContext context, Throwable e);

    void close(RepeatContext context);
}
```

The `open` and `close` callbacks come before and after the entire iteration. `before`, `after` and `onError` apply to the individual `RepeatCallback` calls.

Note that when there is more than one listener, they are in a list, so there is an order. In this case `open` and `before` are called in the same order while `after`, `onError` and `close` are called in reverse order.

8.5. Parallel Processing

Implementations of `RepeatOperations` are not restricted to executing the callback sequentially. It is quite important that some implementations are able to execute their callbacks in parallel. To this end, Spring Batch provides the `TaskExecutorRepeatTemplate`, which uses the Spring `TaskExecutor` strategy to run the `RepeatCallback`. The default is to use a `SynchronousTaskExecutor`, which has the effect of executing the whole iteration in the same thread (the same as a normal `RepeatTemplate`).

8.6. Declarative Iteration

Sometimes there is some business processing that you know you want to repeat every time it happens. The classic example of this is the optimization of a message pipeline - it is more efficient

to process a batch of messages, if they are arriving frequently, than to bear the cost of a separate transaction for every message. Spring Batch provides an AOP interceptor that wraps a method call in a `RepeatOperations` for just this purpose. The `RepeatOperationsInterceptor` executes the intercepted method and repeats according to the `CompletionPolicy` in the provided `RepeatTemplate`.

Here is an example of declarative iteration using the Spring AOP namespace to repeat a service call to a method called `processMessage` (for more detail on how to configure AOP interceptors see the Spring User Guide):

```
<aop:config>
  <aop:pointcut id="transactional"
    expression="execution(* com...*Service.processMessage(..))" />
  <aop:advisor pointcut-ref="transactional"
    advice-ref="retryAdvice" order="-1"/>
</aop:config>

<bean id="retryAdvice" class="org.spr...RepeatOperationsInterceptor"/>
```

The example above uses a default `RepeatTemplate` inside the interceptor. To change the policies, listeners etc. you only need to inject an instance of `RepeatTemplate` into the interceptor.

If the intercepted method returns `void` then the interceptor always returns `ExitStatus.CONTINUABLE` (so there is a danger of an infinite loop if the `CompletionPolicy` does not have a finite end point). Otherwise it returns `ExitStatus.CONTINUABLE` until the return value from the intercepted method is null, at which point it returns `ExitStatus.FINISHED`. So the business logic inside the target method can signal that there is no more work to do by returning `null`, or by throwing an exception that is re-thrown by the `ExceptionHandler` in the provided `RepeatTemplate`.

Chapter 9. Retry

9.1. RetryTemplate

To make processing more robust and less prone to failure, sometimes it helps to automatically retry a failed operation in case it might succeed on a subsequent attempt. Errors that are susceptible to this kind of treatment are transient in nature. For example a remote call to a web service or RMI service that fails because of a network glitch or a `DeadLockLoserException` in a database update may resolve themselves after a short wait. To automate the retry of such operations Spring Batch has the `RetryOperations` strategy. The `RetryOperations` interface looks like this:

```
public interface RetryOperations {

    <T> T execute(RetryCallback<T> retryCallback) throws Exception;

    <T> T execute(RetryCallback<T> retryCallback, RecoveryCallback<T> recoveryCallback)
        throws Exception;

    <T> T execute(RetryCallback<T> retryCallback, RetryState retryState)
        throws Exception, ExhaustedRetryException;

    <T> T execute(RetryCallback<T> retryCallback, RecoveryCallback<T> recoveryCallback,
        RetryState retryState) throws Exception;

}
```

The basic callback is a simple interface that allows you to insert some business logic to be retried:

```
public interface RetryCallback<T> {

    T doWithRetry(RetryContext context) throws Throwable;

}
```

The callback is executed and if it fails (by throwing an `Exception`), it will be retried until either it is successful, or the implementation decides to abort. There are a number of overloaded `execute` methods in the `RetryOperations` interface dealing with various use cases for recovery when all retry attempts are exhausted, and also with retry state, which allows clients and implementations to store information between calls (more on this later).

The simplest general purpose implementation of `RetryOperations` is `RetryTemplate`. It could be used like this

```
RetryTemplate template = new RetryTemplate();

template.setRetryPolicy(new TimeoutRetryPolicy(30000L));

Foo result = template.execute(new RetryCallback<Foo>() {

    public Foo doWithRetry(RetryContext context) {
        // Do stuff that might fail, e.g. webservice operation
        return result;
    }

});
```

In the example we execute a web service call and return the result to the user. If that call fails then it is retried until a timeout is reached.

9.1.1. RetryContext

The method parameter for the `RetryCallback` is a `RetryContext`. Many callbacks will simply ignore the context, but if necessary it can be used as an attribute bag to store data for the duration of the iteration.

A `RetryContext` will have a parent context if there is a nested retry in progress in the same thread. The parent context is occasionally useful for storing data that need to be shared between calls to `execute`.

9.1.2. RecoveryCallback

When a retry is exhausted the `RetryOperations` can pass control to a different callback, the `RecoveryCallback`. To use this feature clients just pass in the callbacks together to the same method, for example:

```
Foo foo = template.execute(new RetryCallback<Foo>() {
    public Foo doWithRetry(RetryContext context) {
        // business logic here
    },
    new RecoveryCallback<Foo>() {
        Foo recover(RetryContext context) throws Exception {
            // recover logic here
        }
    });
```

If the business logic does not succeed before the template decides to abort, then the client is given the chance to do some alternate processing through the recovery callback.

9.1.3. Stateless Retry

In the simplest case, a retry is just a while loop: the `RetryTemplate` can just keep trying until it either succeeds or fails. The `RetryContext` contains some state to determine whether to retry or abort, but this state is on the stack and there is no need to store it anywhere globally, so we call this stateless retry. The distinction between stateless and stateful retry is contained in the implementation of the `RetryPolicy` (the `RetryTemplate` can handle both). In a stateless retry, the callback is always executed in the same thread on retry as when it failed.

9.1.4. Stateful Retry

Where the failure has caused a transactional resource to become invalid, there are some special considerations. This does not apply to a simple remote call because there is no transactional resource (usually), but it does sometimes apply to a database update, especially when using Hibernate. In this case it only makes sense to rethrow the exception that caused the failure immediately so that the transaction can roll back and we can start a new valid one.

In these cases a stateless retry is not good enough because the re-throw and roll back necessarily involve leaving the `RetryOperations.execute()` method and potentially losing the context that was on the stack. To avoid losing it we have to introduce a storage strategy to lift it off the stack and put it (at a minimum) in heap storage. For this purpose Spring Batch provides a storage strategy `RetryContextCache` which can be injected into the `RetryTemplate`. The default implementation of the `RetryContextCache` is in memory, using a simple `Map`. Advanced usage with multiple processes in a clustered environment might also consider implementing the `RetryContextCache` with a cluster cache of some sort (though, even in a clustered environment this might be overkill).

Part of the responsibility of the `RetryOperations` is to recognize the failed operations when they come back in a new execution (and usually wrapped in a new transaction). To facilitate this, Spring Batch provides the `RetryState` abstraction. This works in conjunction with a special `execute` methods in the `RetryOperations`.

The way the failed operations are recognized is by identifying the state across multiple invocations of the retry. To identify the state, the user can provide an `RetryState` object that is responsible for returning a unique key identifying the item. The identifier is used as a key in the `RetryContextCache`.

Warning

Be very careful with the implementation of `Object.equals()` and `Object.hashCode()` in the key returned by `RetryState`. The best advice is to use a business key to identify the items. In the case of a JMS message the message ID can be used.

When the retry is exhausted there is also the option to handle the failed item in a different way, instead of calling the `RetryCallback` (which is presumed now to be likely to fail). Just like in the stateless case, this option is provided by the `RecoveryCallback`, which can be provided by passing it in to the `execute` method of `RetryOperations`.

The decision to retry or not is actually delegated to a regular `RetryPolicy`, so the usual concerns about limits and timeouts can be injected there (see below).

9.2. Retry Policies

Inside a `RetryTemplate` the decision to retry or fail in the `execute` method is determined by a `RetryPolicy` which is also a factory for the `RetryContext`. The `RetryTemplate` has the responsibility to use the current policy to create a `RetryContext` and pass that in to the `RetryCallback` at every attempt. After a callback fails the `RetryTemplate` has to make a call to the `RetryPolicy` to ask it to update its state (which will be stored in the `RetryContext`), and then it asks the policy if another attempt can be made. If another attempt cannot be made (e.g. a limit is reached or a timeout is detected) then the policy is also responsible for handling the exhausted state. Simple implementations will just throw `RetryExhaustedException` which will cause any enclosing transaction to be rolled back. More sophisticated implementations might attempt to take some recovery action, in which case the transaction can remain intact.



Tip

Failures are inherently either retryable or not - if the same exception is always going to be thrown from the business logic, it doesn't help to retry it. So don't retry on all exception types - try to focus on only those exceptions that you expect to be retryable. It's not usually harmful to the business logic to retry more aggressively, but it's wasteful because if a failure is deterministic there will be time spent retrying something that you know in advance is fatal.

Spring Batch provides some simple general purpose implementations of stateless `RetryPolicy`, for example a `SimpleRetryPolicy`, and the `TimeoutRetryPolicy` used in the example above.

The `SimpleRetryPolicy` just allows a retry on any of a named list of exception types, up to a fixed number of times. It also has a list of "fatal" exceptions that should never be retried, and this list overrides the retryable list so that it can be used to give finer control over the retry behavior:

```

SimpleRetryPolicy policy = new SimpleRetryPolicy(5);
// Retry on all exceptions (this is the default)
policy.setRetryableExceptions(new Class[] {Exception.class});
// ... but never retry IllegalStateException
policy.setFatalExceptions(new Class[] {IllegalStateException.class});

// Use the policy...
RetryTemplate template = new RetryTemplate();
template.setRetryPolicy(policy);
template.execute(new RetryCallback<Foo>() {
    public Foo doWithRetry(RetryContext context) {
        // business logic here
    }
});

```

There is also a more flexible implementation called `ExceptionClassifierRetryPolicy`, which allows the user to configure different retry behavior for an arbitrary set of exception types through the `ExceptionClassifier` abstraction. The policy works by calling on the classifier to convert an exception into a delegate `RetryPolicy`, so for example, one exception type can be retried more times before failure than another by mapping it to a different policy.

Users might need to implement their own retry policies for more customized decisions. For instance, if there is a well-known, solution-specific, classification of exceptions into retryable and not retryable.

9.3. Backoff Policies

When retrying after a transient failure it often helps to wait a bit before trying again, because usually the failure is caused by some problem that will only be resolved by waiting. If a `RetryCallback` fails, the `RetryTemplate` can pause execution according to the `BackoffPolicy` in place.

```

public interface BackoffPolicy {

    BackOffContext start(RetryContext context);

    void backOff(BackOffContext backOffContext)
        throws BackOffInterruptedException;

}

```

A `BackoffPolicy` is free to implement the `backOff` in any way it chooses. The policies provided by Spring Batch out of the box all use `Object.wait()`. A common use case is to backoff with an exponentially increasing wait period, to avoid two retries getting into lock step and both failing - this is a lesson learned from the ethernet. For this purpose Spring Batch provides the `ExponentialBackoffPolicy`.

9.4. Listeners

Often it is useful to be able to receive additional callbacks for cross cutting concerns across a number of different retries. For this purpose Spring Batch provides the `RetryListener` interface. The `RetryTemplate` allows users to register `RetryListeners`, and they will be given callbacks with the `RetryContext` and `Throwable` where available during the iteration.

The interface looks like this:

```

public interface RetryListener {

```

```
void open(RetryContext context, RetryCallback<T> callback);

void onError(RetryContext context, RetryCallback<T> callback, Throwable e);

void close(RetryContext context, RetryCallback<T> callback, Throwable e);
}
```

The `open` and `close` callbacks come before and after the entire retry in the simplest case and `onError` applies to the individual `RetryCallback` calls. The `close` method might also receive a `Throwable`; if there has been an error it is the last one thrown by the `RetryCallback`.

Note that when there is more than one listener, they are in a list, so there is an order. In this case `open` will be called in the same order while `onError` and `close` will be called in reverse order.

9.5. Declarative Retry

Sometimes there is some business processing that you know you want to retry every time it happens. The classic example of this is the remote service call. Spring Batch provides an AOP interceptor that wraps a method call in a `RetryOperations` for just this purpose. The `RetryOperationsInterceptor` executes the intercepted method and retries on failure according to the `RetryPolicy` in the provided `RepeatTemplate`.

Here is an example of declarative iteration using the Spring AOP namespace to repeat a service call to a method called `remoteCall` (for more detail on how to configure AOP interceptors see the [Spring User Guide](#)):

```
<aop:config>
  <aop:pointcut id="transactional"
    expression="execution(* com...*Service.remoteCall(..))" />
  <aop:advisor pointcut-ref="transactional"
    advice-ref="retryAdvice" order="-1" />
</aop:config>

<bean id="retryAdvice"
  class="org.springframework.batch.retry.interceptor.RetryOperationsInterceptor"/>
```

The example above uses a default `RetryTemplate` inside the interceptor. To change the policies or listeners, you only need to inject an instance of `RetryTemplate` into the interceptor.

Chapter 10. Unit Testing

Just as with other application styles, it is extremely important to unit test any code written as part of a batch job as well. The Spring core documentation covers how to unit and integration test with Spring in great detail, so it won't be repeated here. It is important, however, to think about how to 'end to end' test a batch job, which is what this chapter will focus on. The spring-batch-test project includes classes that will help facilitate this end-to-end test approach.

10.1. Creating a Unit Test Class

In order for the unit test to run a batch job, the framework must load the job's `ApplicationContext`. Two annotations are used to trigger this:

- `@RunWith(SpringJUnit4ClassRunner.class)`: Indicates that the class should use Spring's JUnit facilities
- `@ContextConfiguration(locations = {...})`: Indicates which XML files contain the `ApplicationContext`.

```
@RunWith(SpringJUnit4ClassRunner.class)
@ContextConfiguration(locations = { "/simple-job-launcher-context.xml",
                                   "/jobs/skipSampleJob.xml" })
public class SkipSampleFunctionalTests extends AbstractJobTests { ... }
```

10.2. End-To-End Testing of Batch Jobs

'End To End' testing can be defined as testing the complete run of a batch job from beginning to end. This allows for a test that sets up a test condition, executes the job, and verifies the end result.

In the example below, the batch job reads from the database and writes to a flat file. The test method begins by setting up the database with test data. It clears the `CUSTOMER` table and then inserts 10 new records. The test then launches the `Job` using the `launchJob()` method. The `launchJob()` method is provided by the `AbstractJobTests` parent class. Also provided by the super class is `launchJob(JobParameters)`, which allows the test to give particular parameters. The `launchJob()` method returns the `JobExecution` object which is useful for asserting particular information about the `Job` run. In the case below, the test verifies that the `Job` ended with status "COMPLETED".

```
@RunWith(SpringJUnit4ClassRunner.class)
@ContextConfiguration(locations = { "/simple-job-launcher-context.xml",
                                   "/jobs/skipSampleJob.xml" })
public class SkipSampleFunctionalTests extends AbstractJobTests {

    private SimpleJdbcTemplate simpleJdbcTemplate;

    @Autowired
    public void setDataSource(DataSource dataSource) {
        this.simpleJdbcTemplate = new SimpleJdbcTemplate(dataSource);
    }

    @Transactional
    @Test
    public void testJob() throws Exception {
        simpleJdbcTemplate.update("delete from CUSTOMER");
        for (int i = 1; i <= 10; i++) {
            simpleJdbcTemplate.update("insert into CUSTOMER values (?, 0, ?, 100000)",
                                     i, "customer" + i);
        }
    }
}
```

```

    }

    JobExecution jobExecution = this.launchJob();

    Assert.assertEquals("COMPLETED", jobExecution.getExitStatus());
}
}

```

10.3. Testing Individual Steps

For complex batch jobs, test cases in the end-to-end testing approach may become unmanageable. In these cases, it may be more useful to have test cases to test individual steps on their own. The `AbstractJobTests` class contains a method `launchStep` that takes a step name and runs just that particular `Step`. This approach allows for more targeted tests by allowing the test to set up data for just that step and to validate its results directly.

```
JobExecution jobExecution = this.launchStep("loadFileStep");
```

10.4. Validating Output Files

When a batch job writes to the database, it is easy to query the database to verify that the output is as expected. However, if the batch job writes to a file, it is equally important that the output be verified. Spring Batch provides a class `AssertFile` to facilitate the verification of output files. The method `assertFileEquals` takes two `File` objects (or two `Resource` objects) and asserts, line by line, that the two files have the same content. Therefore, it is possible to create a file with the expected output and to compare it to the actual result:

```

private static final String EXPECTED_FILE = "src/main/resources/data/input.txt";
private static final String OUTPUT_FILE = "target/test-outputs/output.txt";

AssertFile.assertFileEquals(new FileSystemResource(EXPECTED_FILE),
    new FileSystemResource(OUTPUT_FILE));

```

10.5. Mocking Domain Objects

Another common issue encountered while writing unit and integration tests for Spring Batch components is how to mock domain objects. A good example is a `StepExecutionListener`, as illustrated below:

```

public class NoWorkFoundStepExecutionListener extends StepExecutionListenerSupport {

    public ExitStatus afterStep(StepExecution stepExecution) {
        if (stepExecution.getReadCount() == 0) {
            throw new NoWorkFoundException("Step has not processed any items");
        }
        return stepExecution.getExitStatus();
    }
}

```

The above listener is provided by the framework and checks a `StepExecution` for an empty read count, thus signifying that no work was done. While this example is fairly simple, it serves to illustrate the types of problems that may be encountered when attempting to unit test classes that implement interfaces requiring Spring Batch domain objects. Consider the above listener's unit test:

```
private NoWorkFoundStepExecutionListener tested = new NoWorkFoundStepExecutionListener();
```

```

@Test
public void testAfterStep() {
    StepExecution stepExecution = new StepExecution("NoProcessingStep",
        new JobExecution(new JobInstance(1L, new JobParameters(),
            "NoProcessingJob")));

    stepExecution.setReadCount(0);

    try {
        tested.afterStep(stepExecution);
        fail();
    } catch (NoWorkFoundException e) {
        assertEquals("Step has not processed any items", e.getMessage());
    }
}

```

Because the Spring Batch domain model follows good object orientated principles, the `StepExecution` requires a `JobExecution`, which requires a `JobInstance` and `JobParameters` in order to create a valid `StepExecution`. While this is good in a solid domain model, it does make creating stub objects for unit testing verbose. To address this issue, the Spring Batch test module includes a factory for creating domain objects: `MetaDataInstanceFactory`. Given this factory, the unit test can be updated to be more concise:

```

private NoWorkFoundStepExecutionListener tested = new NoWorkFoundStepExecutionListener();

@Test
public void testAfterStep() {
    StepExecution stepExecution = MetaDataInstanceFactory.createStepExecution();

    stepExecution.setReadCount(0);

    try {
        tested.afterStep(stepExecution);
        fail();
    } catch (NoWorkFoundException e) {
        assertEquals("Step has not processed any items", e.getMessage());
    }
}

```

The above method for creating a simple `StepExecution` is just one convenience method available within the factory. A full method listing can be found in its [Javadoc](#).

Chapter 11. Common Batch Patterns

Some batch jobs can be assembled purely from off-the-shelf components in Spring Batch. For instance the `ItemReader` and `ItemWriter` implementations can be configured to cover a wide range of scenarios. However, for the majority of cases, custom code will have to be written. The main API entry points for application developers are the `Tasklet`, `ItemReader`, `ItemWriter` and the various listener interfaces. Most simple batch jobs will be able to use off-the-shelf input from a Spring Batch `ItemReader`, but it is often the case that there are custom concerns in the processing and writing, which require developers to implement an `ItemWriter` or `ItemProcessor`.

Here, we provide a few examples of common patterns in custom business logic. These examples primarily feature the listener interfaces. It should be noted that an `ItemReader` or `ItemWriter` can implement a listener interface as well, if appropriate.

11.1. Logging Item Processing and Failures

A common use case is the need for special handling of errors in a step, item by item, perhaps logging to a special channel, or inserting a record into a database. A chunk-oriented `Step` (created from the step factory beans) allows users to implement this use case with a simple `ItemReadListener`, for errors on read, and an `ItemWriteListener`, for errors on write. The below code snippets illustrate a listener that logs both read and write failures:

```
public class ItemFailureLoggerListener extends ItemListenerSupport {

    private static Log logger = LoggerFactory.getLog("item.error");

    public void onReadError(Exception ex) {
        logger.error("Encountered error on read", e);
    }

    public void onWriteError(Exception ex, Object item) {
        logger.error("Encountered error on write", e);
    }

}
```

Having implemented this listener it must be registered with the step:

```
<step id="simpleStep">
    ...
    <listeners>
        <listener class="org.example...ItemFailureLoggerListener"/>
    </listeners>
</step>
```

Remember that if your listener does anything in an `onError()` method, it will be inside a transaction that is going to be rolled back. If you need to use a transactional resource such as a database inside an `onError()` method, consider adding a declarative transaction to that method (see Spring Core Reference Guide for details), and giving its propagation attribute the value `REQUIRES_NEW`.

11.2. Stopping a Job Manually for Business Reasons

Spring Batch provides a `stop()` method through the `JobLauncher` interface, but this is really for use by the operator rather than the application programmer. Sometimes it is more convenient or makes more sense to stop a job execution from within the business logic.

The simplest thing to do is to throw a `RuntimeException` (one that isn't retried indefinitely or skipped). For example, a custom exception type could be used, as in the example below:

```
public class PoisonPillItemWriter implements ItemWriter<T> {

    public void write(T item) throws Exception {
        if (isPoisonPill(item)) {
            throw new PoisonPillException("Posion pill detected: " + item);
        }
    }

}
```

Another simple way to stop a step from executing is to simply return `null` from the `ItemReader`:

```
public class EarlyCompletionItemReader implements ItemReader<T> {

    private ItemReader<T> delegate;

    public void setDelegate(ItemReader<T> delegate) { ... }

    public T read() throws Exception {
        T item = delegate.read();
        if (isEndItem(item)) {
            return null; // end the step here
        }
        return item;
    }

}
```

The previous example actually relies on the fact that there is a default implementation of the `CompletionPolicy` strategy which signals a complete batch when the item to be processed is `null`. A more sophisticated completion policy could be implemented and injected into the `Step` through the `SimpleStepFactoryBean`:

```
<step id="simpleStep">
  <tasklet>
    <chunk reader="reader" writer="writer" commit-interval="10"
      chunk-completion-policy="completionPolicy"/>
  </tasklet>
</step>

<bean id="completionPolicy" class="org.example...SpecialCompletionPolicy"/>
```

An alternative is to set a flag in the `StepExecution`, which is checked by the `Step` implementations in the framework in between item processing. To implement this alternative, we need access to the current `StepExecution`, and this can be achieved by implementing a `StepListener` and registering it with the `Step`. Here is an example of a listener that sets the flag:

```
public class CustomItemWriter extends ItemListenerSupport implements StepListener {

    private StepExecution stepExecution;

    public void beforeStep(StepExecution stepExecution) {
        this.stepExecution = stepExecution;
    }

    public void afterRead(Object item) {
        if (isPoisonPill(item)) {
            stepExecution.setTerminateOnly(true);
        }
    }

}
```

```

    }
}

```

The default behavior here when the flag is set is for the step to throw a `JobInterruptedException`. This can be controlled through the `StepInterruptionPolicy`, but the only choice is to throw or not throw an exception, so this is always an abnormal ending to a job.

11.3. Adding a Footer Record

Often when writing to flat files, a "footer" record must be appended to the end of the file, after all processing has been completed. This can also be achieved using the `FlatFileFooterCallback` interface provided by Spring Batch. The `FlatFileFooterCallback` (and its counterpart, the `FlatFileHeaderCallback`) are optional properties of the `FlatFileItemWriter`:

```

<bean id="itemWriter" class="org.spr...FlatFileItemWriter">
  <property name="resource" ref="outputResource" />
  <property name="lineAggregator" ref="lineAggregator"/>
  <property name="headerCallback" ref="headerCallback" />
  <property name="footerCallback" ref="footerCallback" />
</bean>

```

The footer callback interface is very simple. It has just one method that is called when the footer must be written:

```

public interface FlatFileFooterCallback {

    void writeFooter(Writer writer) throws IOException;

}

```

11.3.1. Writing a Summary Footer

A very common requirement involving footer records is to aggregate information during the output process and to append this information to the end of the file. This footer serves as a summarization of the file or provides a checksum.

For example, if a batch job is writing `Trade` records to a flat file, and there is a requirement that the total amount from all the `Trades` is placed in a footer, then the following `ItemWriter` implementation can be used:

```

public class TradeItemWriter implements ItemWriter<Trade>,
                                       FlatFileFooterCallback {

    private ItemWriter<Trade> delegate;

    private BigDecimal totalAmount = BigDecimal.ZERO;

    public void write(List<? extends Trade> items) {
        BigDecimal chunkTotal = BigDecimal.ZERO;
        for (Trade trade : items) {
            chunkTotal = chunkTotal.add(trade.getAmount());
        }

        delegate.write(items);

        // After successfully writing all items
        totalAmount = totalAmount.add(chunkTotal);
    }
}

```

```

    }

    public void writeFooter(Writer writer) throws IOException {
        writer.write("Total Amount Processed: " + totalAmount);
    }

    public void setDelegate(ItemWriter delegate) {...}
}

```

This `TradeItemWriter` stores a `totalAmount` value that is increased with the amount from each `Trade` item written. After the last `Trade` is processed, the framework will call `writeFooter`, which will put that `totalAmount` into the file. Note that the `write` method makes use of a temporary variable, `chunkTotalAmount`, that stores the total of the trades in the chunk. This is done to ensure that if a skip occurs in the `write` method, that the `totalAmount` will be left unchanged. It is only at the end of the `write` method, once we are guaranteed that no exceptions will be thrown, that we update the `totalAmount`.

In order for the `writeFooter` method to be called, the `TradeItemWriter` (which implements `FlatFileFooterCallback`) must be wired into the `FlatFileItemWriter` as the `footerCallback`:

```

<bean id="tradeItemWriter" class="..TradeItemWriter">
    <property name="delegate" ref="flatFileItemWriter" />
</bean>

<bean id="flatFileItemWriter" class="org.spr...FlatFileItemWriter">
    <property name="resource" ref="outputResource" />
    <property name="lineAggregator" ref="lineAggregator"/>
    <property name="footerCallback" ref="tradeItemWriter" />
</bean>

```

The way that the `TradeItemWriter` has been so far will only function correctly if the `Step` is not restartable. This is because the class is stateful (since it stores the `totalAmount`), but the `totalAmount` is not persisted to the database, and therefore, it cannot be retrieved in the event of a restart. In order to make this class restartable, the `ItemStream` interface should be implemented along with the methods `open` and `update`:

```

public void open(ExecutionContext executionContext) {
    if (executionContext.containsKey("total.amount") {
        totalAmount = (BigDecimal) executionContext.get("total.amount");
    }
}

public void update(ExecutionContext executionContext) {
    executionContext.put("total.amount", totalAmount);
}

```

The `update` method will store the most current version of `totalAmount` to the `ExecutionContext` just before that object is persisted to the database. The `open` method will retrieve any existing `totalAmount` from the `ExecutionContext` and use it as the starting point for processing, allowing the `TradeItemWriter` to pick up on restart where it left off the previous time the `Step` was executed.

11.4. Driving Query Based ItemReaders

In the chapter on readers and writers, database input using paging was discussed. Many database vendors, such as DB2, have extremely pessimistic locking strategies that can cause issues if the table being read also needs to be used by other portions of the online application. Furthermore, opening cursors over extremely large datasets can cause issues on certain vendors. Therefore, many projects

prefer to use a 'Driving Query' approach to reading in data. This approach works by iterating over keys, rather than the entire object that needs to be returned, as the following example illustrates:

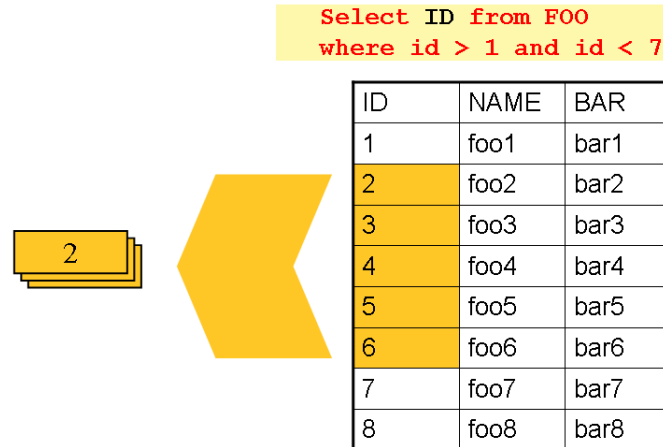

As you can see, this example uses the same 'FOO' table as was used in the cursor based example. However, rather than selecting the entire row, only the ID's were selected in the SQL statement. So, rather than a FOO object being returned from `read`, an Integer will be returned. This number can then be used to query for the 'details', which is a complete Foo object:

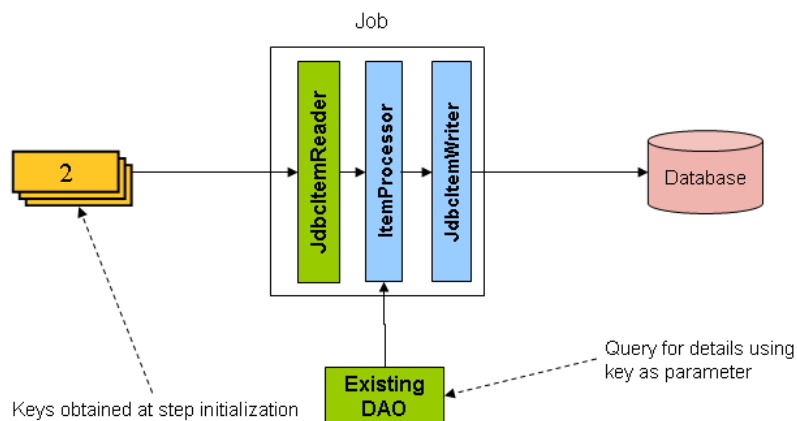

An ItemProcessor should be used to transform the key obtained from the driving query into a full 'Foo' object. An existing DAO can be used to query for the full object based on the key.

11.5. Multi-Line Records

While it is usually the case with flat files that one each record is confined to a single line, it is common that a file might have records spanning multiple lines with multiple formats. The following excerpt from a file illustrates this:

```
HEA;0013100345;2007-02-15
NCU;Smith;Peter;;T;20014539;F
BAD;;Oak Street 31/A;;Small Town;00235;IL;US
FOT;2;2;267.34
```

Everything between the line starting with 'HEA' and the line starting with 'FOT' is considered one record. There are a few considerations that must be made in order to handle this situation correctly:

- Instead of reading one record at a time, the `ItemReader` must read every line of the multi-line record as a group, so that it can be passed to the `ItemWriter` intact.
- Each line type may need to be tokenized differently.

Because a single record spans multiple lines, and we may not know how many lines there are, the `ItemReader` must be careful to always read an entire record. In order to do this, a custom `ItemReader` should be implemented as a wrapper for the `FlatFileItemReader`.

```
<bean id="itemReader" class="org.spr...MultiLineTradeItemReader">
  <property name="delegate">
    <bean class="org.springframework.batch.item.file.FlatFileItemReader">
      <property name="resource" value="data/iosample/input/multiLine.txt" />
      <property name="lineMapper">
        <bean class="org.spr...DefaultLineMapper">
          <property name="lineTokenizer" ref="orderFileTokenizer"/>
          <property name="fieldSetMapper">
            <bean class="org.spr...PassThroughFieldSetMapper" />
          </property>
        </bean>
      </property>
    </bean>
  </property>
</bean>
```

To ensure that each line is tokenized properly, which is especially important for fixed length input, the `PatternMatchingCompositeLineTokenizer` can be used on the delegate `FlatFileItemReader`. See Section 6.6.2.9, “Multiple Record Types within a Single File” for more details. The delegate reader will then use a `PassThroughFieldSetMapper` to deliver a `FieldSet` for each line back to the wrapping `ItemReader`.

```
<bean id="orderFileTokenizer" class="org.spr...PatternMatchingCompositeLineTokenizer">
  <property name="tokenizers">
    <map>
      <entry key="HEA*" value-ref="headerRecordTokenizer" />
      <entry key="FOT*" value-ref="footerRecordTokenizer" />
      <entry key="NCU*" value-ref="customerLineTokenizer" />
      <entry key="BAD*" value-ref="billingAddressLineTokenizer" />
    </map>
  </property>
</bean>
```

This wrapper will have to be able recognize the end of a record so that it can continually call `read()` on its delegate until the end is reached. For each line that is read, the wrapper should build up the item to be returned. Once the footer is reached, the item can be returned for delivery to the `ItemProcessor` and `ItemWriter`.

```
private FlatFileItemReader<FieldSet> delegate;

public Trade read() throws Exception {
    Trade t = null;

    for (FieldSet line = null; (line = this.delegate.read()) != null;) {
        String prefix = line.readString(0);
        if (prefix.equals("HEA")) {
            t = new Trade(); // Record must start with header
        }
    }
}
```

```

else if (prefix.equals("NCU")) {
    Assert.notNull(t, "No header was found.");
    t.setLast(line.readString(1));
    t.setFirst(line.readString(2));
    ...
}
else if (prefix.equals("BAD")) {
    Assert.notNull(t, "No header was found.");
    t.setCity(line.readString(4));
    t.setState(line.readString(6));
    ...
}
else if (prefix.equals("FOT")) {
    return t; // Record must end with footer
}
}
Assert.isNull(t, "No 'END' was found.");
return null;
}

```

11.6. Executing System Commands

Many batch jobs may require that an external command be called from within the batch job. Such a process could be kicked off separately by the scheduler, but the advantage of common meta-data about the run would be lost. Furthermore, a multi-step job would also need to be split up into multiple jobs as well.

Because the need is so common, Spring Batch provides a `Tasklet` implementation for calling system commands:

```

<bean class="org.springframework.batch.core.step.tasklet.SystemCommandTasklet">
  <property name="command" value="echo hello" />
  <!-- 5 second timeout for the command to complete -->
  <property name="timeout" value="5000" />
</bean>

```

11.7. Handling Step Completion When No Input is Found

In many batch scenarios, finding no rows in a database or file to process is not exceptional. The `Step` is simply considered to have found no work and completes with 0 items read. All of the `ItemReader` implementations provided out of the box in Spring Batch default to this approach. This can lead to some confusion if nothing is written out even when input is present. (which usually happens if a file was misnamed, etc) For this reason, the meta data itself should be inspected to determine how much work the framework found to be processed. However, what if finding no input is considered exceptional? In this case, programmatically checking the meta data for no items processed and causing failure is the best solution. Because this is a common use case, a listener is provided with just this functionality:

```

public class NoWorkFoundStepExecutionListener extends StepExecutionListenerSupport {

    public ExitStatus afterStep(StepExecution stepExecution) {
        if (stepExecution.getReadCount() == 0) {
            return ExitStatus.FAILED;
        }
        return null;
    }
}

```

The above `StepExecutionListener` inspects the `readCount` property of the `StepExecution` during the 'afterStep' phase to determine if no items were read. If that is the case, an exit code of `FAILED` is returned, indicating that the `Step` should fail. Otherwise, `null` is returned, which will not affect the status of the `Step`.

11.8. Passing Data to Future Steps

It is often useful to pass information from one step to another. This can be done using the `ExecutionContext`. The catch is that there are two `ExecutionContexts`: one at the `Step` level and one at the `Job` level. The `Step ExecutionContext` lives only as long as the step while the `Job ExecutionContext` lives through the whole `Job`. On the other hand, the `Step ExecutionContext` is updated every time the `Step` commits a chunk while the `Job ExecutionContext` is updated only at the end of each `Step`.

The consequence of this separation is that all data must be placed in the `Step ExecutionContext` while the `Step` is executing. This will ensure that the data will be stored properly while the `Step` is on-going. If data is stored to the `Job ExecutionContext`, then it will not be persisted during `Step` execution and if the `Step` fails, that data will be lost.

```
public void SavingItemWriter implements ItemWriter<Object> {
    private StepExecution stepExecution;

    public void write(List<? extends Object> items) throws Exception {
        // ...

        ExecutionContext stepContext = this.stepExecution.getExecutionContext();
        stepContext.put("someKey", someObject);
    }

    @BeforeStep
    public void saveStepExecution(StepExecution stepExecution) {
        this.stepExecution = stepExecution;
    }
}
```

To make the data available to future `Steps`, it will have to be "promoted" to the `Job ExecutionContext` after the step has finished. Spring Batch provides the `ExecutionContextPromotionListener` for this purpose. The listener must be configured with the keys related to the data in the `ExecutionContext` that must be promoted. It can also, optionally, be configured with a list of exit code patterns for which the promotion should occur ("`COMPLETED`" is the default). As with all listeners, it must be registered on the `Step`.

```
<job id="job1">
  <step id="step1">
    <tasklet>
      <chunk reader="reader" writer="savingWriter" commit-interval="10"/>
      <listeners>
        <listener ref="promotionListener"/>
      </listeners>
    </tasklet>
  </step>

  <step id="step2">
    ...
  </step>
</job>

<beans:bean id="promotionListener" class="org.spr....ExecutionContextPromotionListener">
```

```
<beans:property name="keys" value="someKey"/>
</beans:bean>
```

Finally, the saved values must be retrieved from the `Job ExecutionContext`:

```
public void RetrievingItemWriter implements ItemWriter<Object> {
    private Object someObject;

    public void write(List<? extends Object> items) throws Exception {
        // ...
    }

    @BeforeStep
    public void saveStepExecution(StepExecution stepExecution) {
        JobExecution jobExecution = stepExecution.getJobExecution();
        ExecutionContext jobContext = jobExecution.getExecutionContext();
        this.someObject = jobContext.get("someKey");
    }
}
```

Table A.1. Available Item Readers

		Full ItemReader that delivers a list as its item, storing up objects from the injected ItemReader until they are ready to be packed out as a collection. This ItemReader should mark the beginning and end of records with the constants <code>AggregateItemReader#BEGIN_RECORD</code> and <code>AggregateItemReader#END_RECORD</code> .
	FlatFileItemReader	Reads from a flat file. Includes <code>ItemStream</code> and <code>Skippable</code> functionality. See section on <code>Read from a File</code> .
	StaxEventItemReader	Reads via StAX. See <code>HOWTO - Read from a File</code> .
	JdbcCursorItemReader	Reads from a database cursor via JDBC. See <code>HOWTO - Read from a Database</code> .
	HibernateCursorItemReader	Reads from a cursor based on an HQL query. See section on <code>Reading from a Database</code> .

Appendix A. List of ItemReaders and ItemWriters

A.1. Item Readers

	Item Reader	Description
	IbatisPagingItemReader	Reads via iBATIS based on a query. Pages through the rows so that large datasets can be read without running out of memory. See <code>HOWTO - Read from a Database</code> .
	AbstractItemStreamItemWriter	Abstract base class that combines the <code>ItemStream</code> and <code>ItemWriter</code> interfaces.
	CompositeItemWriter	Passes an item to the <code>process</code> method of each in an injected <code>List of ItemWriter</code> objects.
	JmsItemReader	Given a <code>Spring.JmsOperations</code> object and a JMS Destination or destination name to send errors, adapts any class to the interface.
	ItemWriterAdapter	Adapts any class to the interface.
	PropertyExtractingDelegatingItemWriter	<code>JmsOperations.receive()</code> method. Extends <code>AbstractMethodInvokingDelegator</code> creating arguments on the fly. Arguments are created by retrieving the values from the fields within the item to be processed (via a <code>SpringBeanWrapper</code>) based on an injected array of field name.
	JpaPagingItemReader	Given a SQL statement, pages through the rows, such as <code>UPDATE</code> statements.
	JdbcPagingItemReader	Writes to a flat file. Includes <code>ItemStream</code> and <code>Skippable</code> functionality. See section on <code>Writing to a File</code> .
	FlatFileItemWriter	Writes to a flat file. Includes <code>ItemStream</code> and <code>Skippable</code> functionality. See section on <code>Writing to a File</code> .

A.2. Item Writers

	HibernateItemWriter	This item writer is hibernate session aware and handles some transaction-related work that a non-"hibernate aware" item writer would not need to know about and then delegates to another item writer to do the actual writing.
	JdbcBatchItemWriter	Uses batching features from a <code>PreparedStatement</code> , if available, and can take rudimentary steps to locate a failure during a <code>flush</code> .
	JpaItemWriter	This item writer is JPA <code>EntityManager</code> aware and handles some transaction-related work that a non-"jpa aware" <code>ItemWriter</code> would not need to know about and then delegates to another writer to do the actual writing.
	StaxEventItemWriter	Uses an <code>ObjectToXmlSerializer</code> implementation to convert each item to XML and then writes it to an XML file using StAX.

Appendix B. Meta-Data Schema

B.1. Overview

The Spring Batch Meta-Data tables very closely match the Domain objects that represent them in Java. For example, `JobInstance`, `JobExecution`, `JobParameters`, and `StepExecution` map to `BATCH_JOB_INSTANCE`, `BATCH_JOB_EXECUTION`, `BATCH_JOB_PARAMS`, and `BATCH_STEP_EXECUTION`, respectively. `ExecutionContext` maps to both `BATCH_JOB_EXECUTION_CONTEXT` and `BATCH_STEP_EXECUTION_CONTEXT`. The `JobRepository` is responsible for saving and storing each Java object into its correct table. The following appendix describes the meta-data tables in detail, along with many of the design decisions that were made when creating them. When viewing the various table creation statements below, it is important to realize that the data types used are as generic as possible. Spring Batch provides many schemas as examples, which all have varying data types due to variations in individual database vendors' handling of data types. Below is an ERD model of all 6 tables and their relationships to one another:

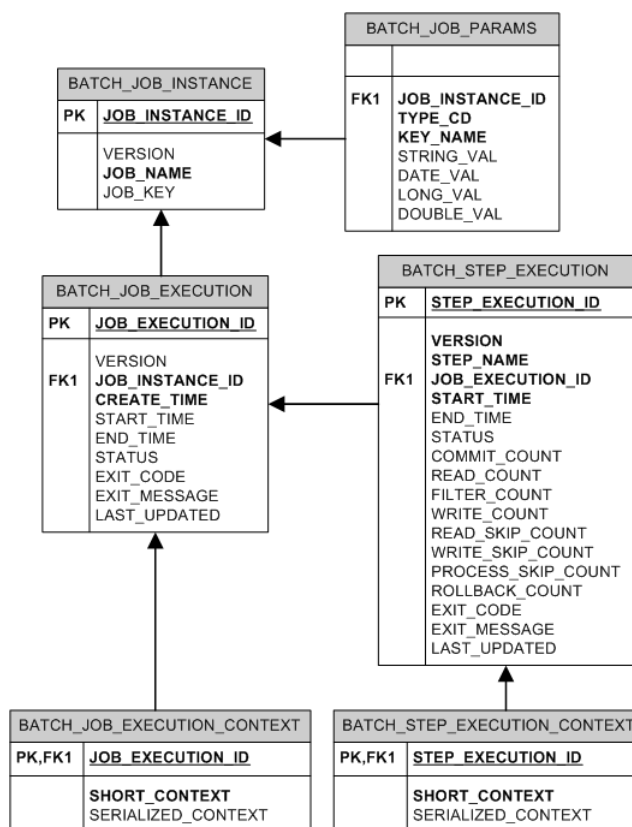

B.1.1. Example DDL Scripts

The root of the Spring Batch Core JAR file contains example scripts to create the relational tables for a number of database platforms (which are in turn auto-detected by the job repository factory bean or namespace equivalent). These scripts can be used as is, or modified with additional indexes and constraints as desired. The file names are in the form `schema-*.sql`, where "*" is the short name of the target database platform.

B.1.2. Version

Many of the database tables discussed in this appendix contain a version column. This column is important because Spring Batch employs an optimistic locking strategy when dealing with updates to the database. This means that each time a record is 'touched' (updated) the value in the version column is incremented by one. When the repository goes back to try and save the value, if the version number has change it will throw `OptimisticLockingFailureException`, indicating there has been an error with concurrent access. This check is necessary since, even though different batch jobs may be running in different machines, they are all using the same database tables.

B.1.3. Identity

`BATCH_JOB_INSTANCE`, `BATCH_JOB_EXECUTION`, and `BATCH_STEP_EXECUTION` each contain columns ending in `_ID`. These fields act as primary keys for their respective tables. However, they are not database generated keys, but rather they are generated by separate sequences. This is necessary because after inserting one of the domain objects into the database, the key it is given needs to be set on the actual object so that they can be uniquely identified in Java. Newer database drivers (Jdbc 3.0 and up) support this feature with database generated keys, but rather than requiring it, sequences were used. Each variation of the schema will contain some form of the following:

```
CREATE SEQUENCE BATCH_STEP_EXECUTION_SEQ;
CREATE SEQUENCE BATCH_JOB_EXECUTION_SEQ;
CREATE SEQUENCE BATCH_JOB_SEQ;
```

Many database vendors don't support sequences. In these cases, work-arounds are used, such as the following for mySQL:

```
CREATE TABLE BATCH_STEP_EXECUTION_SEQ (ID BIGINT NOT NULL) type=MYISAM;
INSERT INTO BATCH_STEP_EXECUTION_SEQ values(0);
CREATE TABLE BATCH_JOB_EXECUTION_SEQ (ID BIGINT NOT NULL) type=MYISAM;
INSERT INTO BATCH_JOB_EXECUTION_SEQ values(0);
CREATE TABLE BATCH_JOB_SEQ (ID BIGINT NOT NULL) type=MYISAM;
INSERT INTO BATCH_JOB_SEQ values(0);
```

In the above case, a table is used in place of each sequence. The Spring core class `MySQLMaxValueIncrementer` will then increment the one column in this sequence in order to give similar functionality.

B.2. BATCH_JOB_INSTANCE

The `BATCH_JOB_INSTANCE` table holds all information relevant to a `JobInstance`, and serves as the top of the overall hierarchy. The following generic DDL statement is used to create it:

```
CREATE TABLE BATCH_JOB_INSTANCE (
  JOB_INSTANCE_ID BIGINT PRIMARY KEY ,
  VERSION BIGINT,
  JOB_NAME VARCHAR(100) NOT NULL ,
  JOB_KEY VARCHAR(2500)
);
```

Below are descriptions of each column in the table:

- `JOB_INSTANCE_ID`: The unique id that will identify the instance, which is also the primary key. The value of this column should be obtainable by calling the `getId` method on `JobInstance`.

- **VERSION:** See above section.
- **JOB_NAME:** Name of the job obtained from the `Job` object. Because it is required to identify the instance, it must not be null.
- **JOB_KEY:** A serialization of the `JobParameters` that uniquely identifies separate instances of the same job from one another. (`JobInstances` with the same job name must have different `JobParameters`, and thus, different `JOB_KEY` values).

B.3. BATCH_JOB_PARAMS

The `BATCH_JOB_PARAMS` table holds all information relevant to the `JobParameters` object. It contains 0 or more key/value pairs that together uniquely identify a `JobInstance` and serve as a record of the parameters a job was run with. It should be noted that the table has been denormalized. Rather than creating a separate table for each type, there is one table with a column indicating the type:

```
CREATE TABLE BATCH_JOB_PARAMS (
  JOB_INSTANCE_ID BIGINT NOT NULL ,
  TYPE_CD VARCHAR(6) NOT NULL ,
  KEY_NAME VARCHAR(100) NOT NULL ,
  STRING_VAL VARCHAR(250) ,
  DATE_VAL TIMESTAMP DEFAULT NULL,
  LONG_VAL BIGINT ,
  DOUBLE_VAL DOUBLE PRECISION,
  constraint JOB_INSTANCE_PARAMS_FK foreign key (JOB_INSTANCE_ID)
  references BATCH_JOB_INSTANCE(JOB_INSTANCE_ID)
);
```

Below are descriptions for each column:

- **JOB_INSTANCE_ID:** Foreign Key from the `BATCH_JOB_INSTANCE` table that indicates the job instance the parameter entry belongs to. It should be noted that multiple rows (i.e key/value pairs) may exist for each instance.
- **TYPE_CD:** String representation of the type of value stored, which can be either a string, date, long, or double. Because the type must be known, it cannot be null.
- **KEY_NAME:** The parameter key.
- **STRING_VAL:** Parameter value, if the type is string.
- **DATE_VAL:** Parameter value, if the type is date.
- **LONG_VAL:** Parameter value, if the type is a long.
- **DOUBLE_VAL:** Parameter value, if the type is double.

It is worth noting that there is no primary key for this table. This is simply because the framework has no use for one, and thus doesn't require it. If a user so chooses, one may be added with a database generated key, without causing any issues to the framework itself.

B.4. BATCH_JOB_EXECUTION

The `BATCH_JOB_EXECUTION` table holds all information relevant to the `JobExecution` object. Every time a `Job` is run there will always be a new `JobExecution`, and a new row in this table:

```

CREATE TABLE BATCH_JOB_EXECUTION (
  JOB_EXECUTION_ID BIGINT PRIMARY KEY ,
  VERSION BIGINT,
  JOB_INSTANCE_ID BIGINT NOT NULL,
  CREATE_TIME TIMESTAMP NOT NULL,
  START_TIME TIMESTAMP DEFAULT NULL,
  END_TIME TIMESTAMP DEFAULT NULL,
  STATUS VARCHAR(10),
  EXIT_CODE VARCHAR(20),
  EXIT_MESSAGE VARCHAR(2500),
  LAST_UPDATED TIMESTAMP,
  constraint JOB_INSTANCE_EXECUTION_FK foreign key (JOB_INSTANCE_ID)
  references BATCH_JOB_INSTANCE(JOB_INSTANCE_ID)
) ;

```

Below are descriptions for each column:

- **JOB_EXECUTION_ID**: Primary key that uniquely identifies this execution. The value of this column is obtainable by calling the `getId` method of the `JobExecution` object.
- **VERSION**: See above section.
- **JOB_INSTANCE_ID**: Foreign key from the `BATCH_JOB_INSTANCE` table indicating the instance to which this execution belongs. There may be more than one execution per instance.
- **CREATE_TIME**: Timestamp representing the time that the execution was created.
- **START_TIME**: Timestamp representing the time the execution was started.
- **END_TIME**: Timestamp representing the time the execution was finished, regardless of success or failure. An empty value in this column even though the job is not currently running indicates that there has been some type of error and the framework was unable to perform a last save before failing.
- **STATUS**: Character string representing the status of the execution. This may be `COMPLETED`, `STARTED`, etc. The object representation of this column is the `BatchStatus` enumeration.
- **EXIT_CODE**: Character string representing the exit code of the execution. In the case of a command line job, this may be converted into a number.
- **EXIT_MESSAGE**: Character string representing a more detailed description of how the job exited. In the case of failure, this might include as much of the stack trace as is possible.
- **LAST_UPDATED**: Timestamp representing the last time this execution was persisted.

B.5. BATCH_STEP_EXECUTION

The `BATCH_STEP_EXECUTION` table holds all information relevant to the `StepExecution` object. This table is very similar in many ways to the `BATCH_JOB_EXECUTION` table and there will always be at least one entry per `Step` for each `JobExecution` created:

```

CREATE TABLE BATCH_STEP_EXECUTION (
  STEP_EXECUTION_ID BIGINT PRIMARY KEY ,
  VERSION BIGINT NOT NULL,
  STEP_NAME VARCHAR(100) NOT NULL,
  JOB_EXECUTION_ID BIGINT NOT NULL,
  START_TIME TIMESTAMP NOT NULL ,
  END_TIME TIMESTAMP DEFAULT NULL,
  STATUS VARCHAR(10),
  COMMIT_COUNT BIGINT ,

```

```

    READ_COUNT BIGINT ,
    FILTER_COUNT BIGINT ,
    WRITE_COUNT BIGINT ,
    READ_SKIP_COUNT BIGINT ,
    WRITE_SKIP_COUNT BIGINT ,
    PROCESS_SKIP_COUNT BIGINT ,
    ROLLBACK_COUNT BIGINT ,
    EXIT_CODE VARCHAR(20) ,
    EXIT_MESSAGE VARCHAR(2500) ,
    LAST_UPDATED TIMESTAMP,
    constraint JOB_EXECUTION_STEP_FK foreign key (JOB_EXECUTION_ID)
    references BATCH_JOB_EXECUTION(JOB_EXECUTION_ID)
) ;

```

Below are descriptions for each column:

- **STEP_EXECUTION_ID**: Primary key that uniquely identifies this execution. The value of this column should be obtainable by calling the `getId` method of the `StepExecution` object.
- **VERSION**: See above section.
- **STEP_NAME**: The name of the step to which this execution belongs.
- **JOB_EXECUTION_ID**: Foreign key from the `BATCH_JOB_EXECUTION` table indicating the `JobExecution` to which this `StepExecution` belongs. There may be only one `StepExecution` for a given `JobExecution` for a given `Step` name.
- **START_TIME**: Timestamp representing the time the execution was started.
- **END_TIME**: Timestamp representing the time the execution was finished, regardless of success or failure. An empty value in this column even though the job is not currently running indicates that there has been some type of error and the framework was unable to perform a last save before failing.
- **STATUS**: Character string representing the status of the execution. This may be `COMPLETED`, `STARTED`, etc. The object representation of this column is the `BatchStatus` enumeration.
- **COMMIT_COUNT**: The number of times in which the step has committed a transaction during this execution.
- **READ_COUNT**: The number of items read during this execution.
- **FILTER_COUNT**: The number of items filtered out of this execution.
- **WRITE_COUNT**: The number of items written and committed during this execution.
- **READ_SKIP_COUNT**: The number of items skipped on read during this execution.
- **WRITE_SKIP_COUNT**: The number of items skipped on write during this execution.
- **PROCESS_SKIP_COUNT**: The number of items skipped during processing during this execution.
- **ROLLBACK_COUNT**: The number of rollbacks during this execution. Note that this count includes each time rollback occurs, including rollbacks for retry and those in the skip recovery procedure.
- **EXIT_CODE**: Character string representing the exit code of the execution. In the case of a command line job, this may be converted into a number.
- **EXIT_MESSAGE**: Character string representing a more detailed description of how the job exited. In the case of failure, this might include as much of the stack trace as is possible.

- `LAST_UPDATED`: Timestamp representing the last time this execution was persisted.

B.6. BATCH_JOB_EXECUTION_CONTEXT

The `BATCH_JOB_EXECUTION_CONTEXT` table holds all information relevant to an `Job`'s `ExecutionContext`. There is exactly one `Job ExecutionContext` per `JobExecution`, and it contains all of the job-level data that is needed for a particular job execution. This data typically represents the state that must be retrieved after a failure so that a `JobInstance` can 'start from where it left off'.

```
CREATE TABLE BATCH_JOB_EXECUTION_CONTEXT (
  JOB_EXECUTION_ID BIGINT PRIMARY KEY,
  SHORT_CONTEXT VARCHAR(2500) NOT NULL,
  SERIALIZED_CONTEXT CLOB,
  constraint JOB_EXEC_CTX_FK foreign key (JOB_EXECUTION_ID)
  references BATCH_JOB_EXECUTION(JOB_EXECUTION_ID)
) ;
```

Below are descriptions for each column:

- `JOB_EXECUTION_ID`: Foreign key representing the `JobExecution` to which the context belongs. There may be more than one row associated to a given execution.
- `SHORT_CONTEXT`: A string version of the `SERIALIZED_CONTEXT`.
- `SERIALIZED_CONTEXT`: The entire context, serialized.

B.7. BATCH_STEP_EXECUTION_CONTEXT

The `BATCH_STEP_EXECUTION_CONTEXT` table holds all information relevant to an `Step`'s `ExecutionContext`. There is exactly one `ExecutionContext` per `StepExecution`, and it contains all of the data that needs to be persisted for a particular step execution. This data typically represents the state that must be retrieved after a failure so that a `JobInstance` can 'start from where it left off'.

```
CREATE TABLE BATCH_STEP_EXECUTION_CONTEXT (
  STEP_EXECUTION_ID BIGINT PRIMARY KEY,
  SHORT_CONTEXT VARCHAR(2500) NOT NULL,
  SERIALIZED_CONTEXT CLOB,
  constraint STEP_EXEC_CTX_FK foreign key (STEP_EXECUTION_ID)
  references BATCH_STEP_EXECUTION(STEP_EXECUTION_ID)
) ;
```

Below are descriptions for each column:

- `STEP_EXECUTION_ID`: Foreign key representing the `StepExecution` to which the context belongs. There may be more than one row associated to a given execution.
- `SHORT_CONTEXT`: A string version of the `SERIALIZED_CONTEXT`.
- `SERIALIZED_CONTEXT`: The entire context, serialized.

B.8. Archiving

Because there are entries in multiple tables every time a batch job is run, it is common to create an archive strategy for the meta-data tables. The tables themselves are designed to show a record of what

happened in the past, and generally won't affect the run of any job, with a couple of notable exceptions pertaining to restart:

- The framework will use the meta-data tables to determine if a particular JobInstance has been run before. If it has been run, and the job is not restartable, then an exception will be thrown.
- If an entry for a JobInstance is removed without having completed successfully, the framework will think that the job is new, rather than a restart.
- If a job is restarted, the framework will use any data that has been persisted to the ExecutionContext to restore the Job's state. Therefore, removing any entries from this table for jobs that haven't completed successfully will prevent them from starting at the correct point if run again.

B.9. Recommendations for Indexing Meta Data Tables

Spring Batch provides DDL samples for the meta-data tables in the Core jar file for several common database platforms. Index declarations are not included in that DDL because there are too many variations in how users may want to index depending on their precise platform, local conventions and also the business requirements of how the jobs will be operated. The table below provides some indication as to which columns are going to be used in a WHERE clause by the Dao implementations provided by Spring Batch, and how frequently they might be used, so that individual projects can make up their own minds about indexing.

Table B.1. Where clauses in SQL statements (excluding primary keys) and their approximate frequency of use.

Default Table Name	Where Clause	Frequency
BATCH_JOB_INSTANCE	JOB_NAME = ? and JOB_KEY = ?	Every time a job is launched
BATCH_JOB_EXECUTION	JOB_INSTANCE_ID = ?	Every time a job is restarted
BATCH_EXECUTION_CONTEXT	EXECUTION_ID = ? and KEY_NAME = ?	On commit interval, a.k.a. chunk
BATCH_STEP_EXECUTION	VERSION = ?	On commit interval, a.k.a. chunk (and at start and end of step)
BATCH_STEP_EXECUTION	STEP_NAME = ? and JOB_EXECUTION_ID = ?	Before each step execution

Glossary

Spring Batch Glossary

Batch	An accumulation of business transactions over time.
Batch Application Style	Term used to designate batch as an application style in its own right similar to online, Web or SOA. It has standard elements of input, validation, transformation of information to business model, business processing and output. In addition, it requires monitoring at a macro level.
Batch Processing	The handling of a batch of many business transactions that have accumulated over a period of time (e.g. an hour, day, week, month, or year). It is the application of a process, or set of processes, to many data entities or objects in a repetitive and predictable fashion with either no manual element, or a separate manual element for error processing.
Batch Window	The time frame within which a batch job must complete. This can be constrained by other systems coming online, other dependent jobs needing to execute or other factors specific to the batch environment.
Step	It is the main batch task or unit of work controller. It initializes the business logic, and controls the transaction environment based on commit interval setting, etc.
Tasklet	A component created by application developer to process the business logic for a Step.
Batch Job Type	Job Types describe application of jobs for particular type of processing. Common areas are interface processing (typically flat files), forms processing (either for online pdf generation or print formats), report processing.
Driving Query	A driving query identifies the set of work for a job to do; the job then breaks that work into individual units of work. For instance, identify all financial transactions that have a status of "pending transmission" and send them to our partner system. The driving query returns a set of record IDs to process; each record ID then becomes a unit of work. A driving query may involve a join (if the criteria for selection falls across two or more tables) or it may work with a single table.
Item	An item represents the smallest amount of complete data for processing. In the simplest terms, this might mean a line in a file, a row in a database table, or a particular element in an XML file.
Logical Unit of Work (LUW)	A batch job iterates through a driving query (or another input source such as a file) to perform the set of work that the job must accomplish. Each iteration of work performed is a unit of work.
Commit Interval	A set of LUWs processed within a single transaction.
Partitioning	Splitting a job into multiple threads where each thread is responsible for a subset of the overall data to be processed. The threads of execution may be within the

same JVM or they may span JVMs in a clustered environment that supports workload balancing.

Staging Table	A table that holds temporary data while it is being processed.
Restartable	A job that can be executed again and will assume the same identity as when run initially. In othewords, it is has the same job instance id.
Rerunnable	A job that is restartable and manages its own state in terms of previous run's record processing. An example of a rerunnable step is one based on a driving query. If the driving query can be formed so that it will limit the processed rows when the job is restarted than it is re-runnable. This is managed by the application logic. Often times a condition is added to the where statement to limit the rows returned by the driving query with something like "and processedFlag != true".
Repeat	One of the most basic units of batch processing, that defines repeatability calling a portion of code until it is finished, and while there is no error. Typically a batch process would be repeatable as long as there is input.
Retry	Simplifies the execution of operations with retry semantics most frequently associated with handling transactional output exceptions. Retry is slightly different from repeat, rather than continually calling a block of code, retry is stateful, and continually calls the same block of code with the same input, until it either succeeds, or some type of retry limit has been exceeded. It is only generally useful if a subsequent invocation of the operation might succeed because something in the environment has improved.
Recover	Recover operations handle an exception in such a way that a repeat process is able to continue.
Skip	Skip is a recovery strategy often used on file input sources as the strategy for ignoring bad input records that failed validation.