



Spring Batch - Reference Documentation

3.0.8.RELEASE

Lucas Ward , Dave Syer , Thomas Risberg , Robert Kasanicky , Dan
Garrette , Wayne Lund , Michael Minella , Chris Schaefer , Gunnar Hillert

Copyright © 2009 2010 2011 2012 2013 2014 GoPivotal, Inc. All Rights Reserved.

Copies of this document may be made for your own use and for distribution to others, provided that you do not charge any fee for such copies and further provided that each copy contains this Copyright Notice, whether distributed in print or electronically.

Table of Contents

1. Spring Batch Introduction	1
1.1. Background	1
1.2. Usage Scenarios	2
1.3. Spring Batch Architecture	2
1.4. General Batch Principles and Guidelines	3
1.5. Batch Processing Strategies	4
2. What's New in Spring Batch 3.0	11
2.1. JSR-352 Support	11
2.2. Promote Spring Batch Integration to Spring Batch	11
2.3. Upgrade to Support Spring 4 and Java 8	11
2.4. JobScope Support	12
2.5. SQLite Support	12
3. The Domain Language of Batch	13
3.1. Job	13
JobInstance	14
JobParameters	15
JobExecution	15
3.2. Step	17
StepExecution	18
3.3. ExecutionContext	19
3.4. JobRepository	21
3.5. JobLauncher	21
3.6. Item Reader	21
3.7. Item Writer	21
3.8. Item Processor	21
3.9. Batch Namespace	21
4. Configuring and Running a Job	23
4.1. Configuring a Job	23
Restartability	23
Intercepting Job Execution	24
Inheriting from a Parent Job	25
JobParametersValidator	25
4.2. Java Config	26
4.3. Configuring a JobRepository	27
Transaction Configuration for the JobRepository	27
Changing the Table Prefix	28
In-Memory Repository	28
Non-standard Database Types in a Repository	29
4.4. Configuring a JobLauncher	29
4.5. Running a Job	30
Running Jobs from the Command Line	30
The CommandLineJobRunner	31
ExitCodes	32
Running Jobs from within a Web Container	32
4.6. Advanced Meta-Data Usage	33
Querying the Repository	34
JobRegistry	34

JobRegistryBeanPostProcessor	35
AutomaticJobRegistrar	35
JobOperator	36
JobParametersIncrementer	37
Stopping a Job	37
Aborting a Job	38
5. Configuring a Step	39
5.1. Chunk-Oriented Processing	39
Configuring a Step	40
Inheriting from a Parent Step	40
Abstract Step	41
Merging Lists	41
The Commit Interval	41
Configuring a Step for Restart	42
Setting a StartLimit	42
Restarting a completed step	42
Step Restart Configuration Example	43
Configuring Skip Logic	44
Configuring Retry Logic	45
Controlling Rollback	45
Transactional Readers	46
Transaction Attributes	46
Registering ItemStreams with the Step	46
Intercepting Step Execution	47
StepExecutionListener	48
ChunkListener	48
ItemReadListener	48
ItemProcessListener	49
ItemWriteListener	49
SkipListener	50
5.2. TaskletStep	50
TaskletAdapter	51
Example Tasklet Implementation	51
5.3. Controlling Step Flow	52
Sequential Flow	52
Conditional Flow	53
Batch Status vs. Exit Status	54
Configuring for Stop	55
The 'End' Element	56
The 'Fail' Element	56
The 'Stop' Element	56
Programmatic Flow Decisions	57
Split Flows	57
Externalizing Flow Definitions and Dependencies Between Jobs	57
5.4. Late Binding of Job and Step Attributes	58
Step Scope	59
Job Scope	60
6. ItemReaders and ItemWriters	61
6.1. ItemReader	61
6.2. ItemWriter	61

6.3. ItemProcessor	62
Chaining ItemProcessors	63
Filtering Records	64
Fault Tolerance	65
6.4. ItemStream	65
6.5. The Delegate Pattern and Registering with the Step	65
6.6. Flat Files	66
The FieldSet	66
FlatFileItemReader	66
LineMapper	68
LineTokenizer	68
FieldSetMapper	68
DefaultLineMapper	69
Simple Delimited File Reading Example	69
Mapping Fields by Name	70
Automapping FieldSets to Domain Objects	71
Fixed Length File Formats	71
Multiple Record Types within a Single File	72
Exception Handling in Flat Files	73
FlatFileItemWriter	74
LineAggregator	74
Simplified File Writing Example	75
FieldExtractor	75
Delimited File Writing Example	76
Fixed Width File Writing Example	77
Handling File Creation	77
6.7. XML Item Readers and Writers	78
StaxEventItemReader	79
StaxEventItemWriter	80
6.8. Multi-File Input	81
6.9. Database	82
Cursor Based ItemReaders	82
JdbcCursorItemReader	82
HibernateCursorItemReader	85
StoredProcedureItemReader	86
Paging ItemReaders	87
JdbcPagingItemReader	87
JpaPagingItemReader	88
IbatisPagingItemReader	89
Database ItemWriters	89
6.10. Reusing Existing Services	91
6.11. Validating Input	92
6.12. Preventing State Persistence	93
6.13. Creating Custom ItemReaders and ItemWriters	93
Custom ItemReader Example	93
Making the ItemReader Restartable	94
Custom ItemWriter Example	96
Making the ItemWriter Restartable	96
7. Scaling and Parallel Processing	97
7.1. Multi-threaded Step	97

7.2. Parallel Steps	98
7.3. Remote Chunking	98
7.4. Partitioning	99
PartitionHandler	101
Partitioner	102
Binding Input Data to Steps	103
8. Repeat	104
8.1. RepeatTemplate	104
RepeatContext	104
RepeatStatus	105
8.2. Completion Policies	105
8.3. Exception Handling	105
8.4. Listeners	106
8.5. Parallel Processing	106
8.6. Declarative Iteration	106
9. Retry	108
9.1. RetryTemplate	108
RetryContext	109
RecoveryCallback	109
Stateless Retry	109
Stateful Retry	109
9.2. Retry Policies	110
9.3. Backoff Policies	111
9.4. Listeners	112
9.5. Declarative Retry	112
10. Unit Testing	113
10.1. Creating a Unit Test Class	113
10.2. End-To-End Testing of Batch Jobs	113
10.3. Testing Individual Steps	114
10.4. Testing Step-Scoped Components	114
10.5. Validating Output Files	115
10.6. Mocking Domain Objects	116
11. Common Batch Patterns	118
11.1. Logging Item Processing and Failures	118
11.2. Stopping a Job Manually for Business Reasons	118
11.3. Adding a Footer Record	120
Writing a Summary Footer	120
11.4. Driving Query Based ItemReaders	121
11.5. Multi-Line Records	122
11.6. Executing System Commands	124
11.7. Handling Step Completion When No Input is Found	124
11.8. Passing Data to Future Steps	125
12. JSR-352 Support	127
12.1. General Notes Spring Batch and JSR-352	127
12.2. Setup	127
Application Contexts	127
Launching a JSR-352 based job	127
12.3. Dependency Injection	129
12.4. Batch Properties	130
Property Support	130

@BatchProperty annotation	130
Property Substitution	130
12.5. Processing Models	131
Item based processing	131
Custom checkpointing	131
12.6. Running a job	132
12.7. Contexts	132
12.8. Step Flow	133
12.9. Scaling a JSR-352 batch job	133
Partitioning	133
12.10. Testing	134
13. Spring Batch Integration	135
13.1. Spring Batch Integration Introduction	135
Namespace Support	135
Launching Batch Jobs through Messages	136
Transforming a file into a JobLaunchRequest	137
The JobExecution Response	137
Spring Batch Integration Configuration	138
Example ItemReader Configuration	138
Providing Feedback with Informational Messages	139
Asynchronous Processors	140
Externalizing Batch Process Execution	141
Remote Chunking	141
Remote Partitioning	144
A. List of ItemReaders and ItemWriters	146
A.1. Item Readers	146
A.2. Item Writers	147
B. Meta-Data Schema	150
B.1. Overview	150
Example DDL Scripts	150
Version	151
Identity	151
B.2. BATCH_JOB_INSTANCE	151
B.3. BATCH_JOB_EXECUTION_PARAMS	152
B.4. BATCH_JOB_EXECUTION	152
B.5. BATCH_STEP_EXECUTION	153
B.6. BATCH_JOB_EXECUTION_CONTEXT	155
B.7. BATCH_STEP_EXECUTION_CONTEXT	155
B.8. Archiving	156
B.9. International and Multi-byte Characters	156
B.10. Recommendations for Indexing Meta Data Tables	156
C. Batch Processing and Transactions	158
C.1. Simple Batching with No Retry	158
C.2. Simple Stateless Retry	158
C.3. Typical Repeat-Retry Pattern	158
C.4. Asynchronous Chunk Processing	160
C.5. Asynchronous Item Processing	160
C.6. Interactions Between Batching and Transaction Propagation	161
C.7. Special Case: Transactions with Orthogonal Resources	162
C.8. Stateless Retry Cannot Recover	162

Glossary 164

1. Spring Batch Introduction

Many applications within the enterprise domain require bulk processing to perform business operations in mission critical environments. These business operations include automated, complex processing of large volumes of information that is most efficiently processed without user interaction. These operations typically include time based events (e.g. month-end calculations, notices or correspondence), periodic application of complex business rules processed repetitively across very large data sets (e.g. Insurance benefit determination or rate adjustments), or the integration of information that is received from internal and external systems that typically requires formatting, validation and processing in a transactional manner into the system of record. Batch processing is used to process billions of transactions every day for enterprises.

Spring Batch is a lightweight, comprehensive batch framework designed to enable the development of robust batch applications vital for the daily operations of enterprise systems. Spring Batch builds upon the productivity, POJO-based development approach, and general ease of use capabilities people have come to know from the Spring Framework, while making it easy for developers to access and leverage more advance enterprise services when necessary. Spring Batch is not a scheduling framework. There are many good enterprise schedulers available in both the commercial and open source spaces such as Quartz, Tivoli, Control-M, etc. It is intended to work in conjunction with a scheduler, not replace a scheduler.

Spring Batch provides reusable functions that are essential in processing large volumes of records, including logging/tracing, transaction management, job processing statistics, job restart, skip, and resource management. It also provides more advance technical services and features that will enable extremely high-volume and high performance batch jobs through optimization and partitioning techniques. Simple as well as complex, high-volume batch jobs can leverage the framework in a highly scalable manner to process significant volumes of information.

1.1 Background

While open source software projects and associated communities have focused greater attention on web-based and SOA messaging-based architecture frameworks, there has been a notable lack of focus on reusable architecture frameworks to accommodate Java-based batch processing needs, despite continued needs to handle such processing within enterprise IT environments. The lack of a standard, reusable batch architecture has resulted in the proliferation of many one-off, in-house solutions developed within client enterprise IT functions.

SpringSource and Accenture have collaborated to change this. Accenture's hands-on industry and technical experience in implementing batch architectures, SpringSource's depth of technical experience, and Spring's proven programming model together mark a natural and powerful partnership to create high-quality, market relevant software aimed at filling an important gap in enterprise Java. Both companies are also currently working with a number of clients solving similar problems developing Spring-based batch architecture solutions. This has provided some useful additional detail and real-life constraints helping to ensure the solution can be applied to the real-world problems posed by clients. For these reasons and many more, SpringSource and Accenture have teamed to collaborate on the development of Spring Batch.

Accenture has contributed previously proprietary batch processing architecture frameworks, based upon decades worth of experience in building batch architectures with the last several generations of platforms, (i.e., COBOL/Mainframe, C++/Unix, and now Java/anywhere) to the Spring Batch project along with committer resources to drive support, enhancements, and the future roadmap.

The collaborative effort between Accenture and SpringSource aims to promote the standardization of software processing approaches, frameworks, and tools that can be consistently leveraged by enterprise users when creating batch applications. Companies and government agencies desiring to deliver standard, proven solutions to their enterprise IT environments will benefit from Spring Batch.

1.2 Usage Scenarios

A typical batch program generally reads a large number of records from a database, file, or queue, processes the data in some fashion, and then writes back data in a modified form. Spring Batch automates this basic batch iteration, providing the capability to process similar transactions as a set, typically in an offline environment without any user interaction. Batch jobs are part of most IT projects and Spring Batch is the only open source framework that provides a robust, enterprise-scale solution.

Business Scenarios

- Commit batch process periodically
- Concurrent batch processing: parallel processing of a job
- Staged, enterprise message-driven processing
- Massively parallel batch processing
- Manual or scheduled restart after failure
- Sequential processing of dependent steps (with extensions to workflow-driven batches)
- Partial processing: skip records (e.g. on rollback)
- Whole-batch transaction: for cases with a small batch size or existing stored procedures/scripts

Technical Objectives

- Batch developers use the Spring programming model: concentrate on business logic; let the framework take care of infrastructure.
- Clear separation of concerns between the infrastructure, the batch execution environment, and the batch application.
- Provide common, core execution services as interfaces that all projects can implement.
- Provide simple and default implementations of the core execution interfaces that can be used 'out of the box'.
- Easy to configure, customize, and extend services, by leveraging the spring framework in all layers.
- All existing core services should be easy to replace or extend, without any impact to the infrastructure layer.
- Provide a simple deployment model, with the architecture JARs completely separate from the application, built using Maven.

1.3 Spring Batch Architecture

Spring Batch is designed with extensibility and a diverse group of end users in mind. The figure below shows a sketch of the layered architecture that supports the extensibility and ease of use for end-user developers.

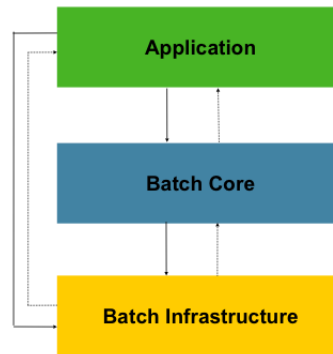

Figure 1.1: Spring Batch Layered Architecture

This layered architecture highlights three major high level components: Application, Core, and Infrastructure. The application contains all batch jobs and custom code written by developers using Spring Batch. The Batch Core contains the core runtime classes necessary to launch and control a batch job. It includes things such as a `JobLauncher`, `Job`, and `Step` implementations. Both Application and Core are built on top of a common infrastructure. This infrastructure contains common readers and writers, and services such as the `RetryTemplate`, which are used both by application developers (`ItemReader` and `ItemWriter`) and the core framework itself. (`retry`)

1.4 General Batch Principles and Guidelines

The following are a number of key principles, guidelines, and general considerations to take into consideration when building a batch solution.

- A batch architecture typically affects on-line architecture and vice versa. Design with both architectures and environments in mind using common building blocks when possible.
- Simplify as much as possible and avoid building complex logical structures in single batch applications.
- Process data as close to where the data physically resides as possible or vice versa (i.e., keep your data where your processing occurs).
- Minimize system resource use, especially I/O. Perform as many operations as possible in internal memory.
- Review application I/O (analyze SQL statements) to ensure that unnecessary physical I/O is avoided. In particular, the following four common flaws need to be looked for:
 - Reading data for every transaction when the data could be read once and kept cached or in the working storage;
 - Rereading data for a transaction where the data was read earlier in the same transaction;
 - Causing unnecessary table or index scans;
 - Not specifying key values in the WHERE clause of an SQL statement.

- Do not do things twice in a batch run. For instance, if you need data summarization for reporting purposes, increment stored totals if possible when data is being initially processed, so your reporting application does not have to reprocess the same data.
- Allocate enough memory at the beginning of a batch application to avoid time-consuming reallocation during the process.
- Always assume the worst with regard to data integrity. Insert adequate checks and record validation to maintain data integrity.
- Implement checksums for internal validation where possible. For example, flat files should have a trailer record telling the total of records in the file and an aggregate of the key fields.
- Plan and execute stress tests as early as possible in a production-like environment with realistic data volumes.
- In large batch systems backups can be challenging, especially if the system is running concurrent with on-line on a 24-7 basis. Database backups are typically well taken care of in the on-line design, but file backups should be considered to be just as important. If the system depends on flat files, file backup procedures should not only be in place and documented, but regularly tested as well.

1.5 Batch Processing Strategies

To help design and implement batch systems, basic batch application building blocks and patterns should be provided to the designers and programmers in form of sample structure charts and code shells. When starting to design a batch job, the business logic should be decomposed into a series of steps which can be implemented using the following standard building blocks:

- *Conversion Applications:* For each type of file supplied by or generated to an external system, a conversion application will need to be created to convert the transaction records supplied into a standard format required for processing. This type of batch application can partly or entirely consist of translation utility modules (see Basic Batch Services).
- *Validation Applications:* Validation applications ensure that all input/output records are correct and consistent. Validation is typically based on file headers and trailers, checksums and validation algorithms as well as record level cross-checks.
- *Extract Applications:* An application that reads a set of records from a database or input file, selects records based on predefined rules, and writes the records to an output file.
- *Extract/Update Applications:* An application that reads records from a database or an input file, and makes changes to a database or an output file driven by the data found in each input record.
- *Processing and Updating Applications:* An application that performs processing on input transactions from an extract or a validation application. The processing will usually involve reading a database to obtain data required for processing, potentially updating the database and creating records for output processing.
- *Output/Format Applications:* Applications reading an input file, restructures data from this record according to a standard format, and produces an output file for printing or transmission to another program or system.

Additionally a basic application shell should be provided for business logic that cannot be built using the previously mentioned building blocks.

In addition to the main building blocks, each application may use one or more of standard utility steps, such as:

- **Sort** - A Program that reads an input file and produces an output file where records have been re-sequenced according to a sort key field in the records. Sorts are usually performed by standard system utilities.
- **Split** - A program that reads a single input file, and writes each record to one of several output files based on a field value. Splits can be tailored or performed by parameter-driven standard system utilities.
- **Merge** - A program that reads records from multiple input files and produces one output file with combined data from the input files. Merges can be tailored or performed by parameter-driven standard system utilities.

Batch applications can additionally be categorized by their input source:

- Database-driven applications are driven by rows or values retrieved from the database.
- File-driven applications are driven by records or values retrieved from a file.
- Message-driven applications are driven by messages retrieved from a message queue.

The foundation of any batch system is the processing strategy. Factors affecting the selection of the strategy include: estimated batch system volume, concurrency with on-line or with another batch systems, available batch windows (and with more enterprises wanting to be up and running 24x7, this leaves no obvious batch windows).

Typical processing options for batch are:

- Normal processing in a batch window during off-line
- Concurrent batch / on-line processing
- Parallel processing of many different batch runs or jobs at the same time
- Partitioning (i.e. processing of many instances of the same job at the same time)
- A combination of these

The order in the list above reflects the implementation complexity, processing in a batch window being the easiest and partitioning the most complex to implement.

Some or all of these options may be supported by a commercial scheduler.

In the following section these processing options are discussed in more detail. It is important to notice that the commit and locking strategy adopted by batch processes will be dependent on the type of processing performed, and as a rule of thumb and the on-line locking strategy should also use the same principles. Therefore, the batch architecture cannot be simply an afterthought when designing an overall architecture.

The locking strategy can use only normal database locks, or an additional custom locking service can be implemented in the architecture. The locking service would track database locking (for example by storing the necessary information in a dedicated db-table) and give or deny permissions to the

application programs requesting a db operation. Retry logic could also be implemented by this architecture to avoid aborting a batch job in case of a lock situation.

1. Normal processing in a batch window For simple batch processes running in a separate batch window, where the data being updated is not required by on-line users or other batch processes, concurrency is not an issue and a single commit can be done at the end of the batch run.

In most cases a more robust approach is more appropriate. A thing to keep in mind is that batch systems have a tendency to grow as time goes by, both in terms of complexity and the data volumes they will handle. If no locking strategy is in place and the system still relies on a single commit point, modifying the batch programs can be painful. Therefore, even with the simplest batch systems, consider the need for commit logic for restart-recovery options as well as the information concerning the more complex cases below.

2. Concurrent batch / on-line processing Batch applications processing data that can simultaneously be updated by on-line users, should not lock any data (either in the database or in files) which could be required by on-line users for more than a few seconds. Also updates should be committed to the database at the end of every few transaction. This minimizes the portion of data that is unavailable to other processes and the elapsed time the data is unavailable.

Another option to minimize physical locking is to have a logical row-level locking implemented using either an Optimistic Locking Pattern or a Pessimistic Locking Pattern.

- Optimistic locking assumes a low likelihood of record contention. It typically means inserting a timestamp column in each database table used concurrently by both batch and on-line processing. When an application fetches a row for processing, it also fetches the timestamp. As the application then tries to update the processed row, the update uses the original timestamp in the WHERE clause. If the timestamp matches, the data and the timestamp will be updated successfully. If the timestamp does not match, this indicates that another application has updated the same row between the fetch and the update attempt and therefore the update cannot be performed.
- Pessimistic locking is any locking strategy that assumes there is a high likelihood of record contention and therefore either a physical or logical lock needs to be obtained at retrieval time. One type of pessimistic logical locking uses a dedicated lock-column in the database table. When an application retrieves the row for update, it sets a flag in the lock column. With the flag in place, other applications attempting to retrieve the same row will logically fail. When the application that set the flag updates the row, it also clears the flag, enabling the row to be retrieved by other applications. Please note, that the integrity of data must be maintained also between the initial fetch and the setting of the flag, for example by using db locks (e.g., SELECT FOR UPDATE). Note also that this method suffers from the same downside as physical locking except that it is somewhat easier to manage building a time-out mechanism that will get the lock released if the user goes to lunch while the record is locked.

These patterns are not necessarily suitable for batch processing, but they might be used for concurrent batch and on-line processing (e.g. in cases where the database doesn't support row-level locking). As a general rule, optimistic locking is more suitable for on-line applications, while pessimistic locking is more suitable for batch applications. Whenever logical locking is used, the same scheme must be used for all applications accessing data entities protected by logical locks.

Note that both of these solutions only address locking a single record. Often we may need to lock a logically related group of records. With physical locks, you have to manage these very carefully in order to avoid potential deadlocks. With logical locks, it is usually best to build a logical lock manager that understands the logical record groups you want to protect and can ensure that locks are coherent and

non-deadlocking. This logical lock manager usually uses its own tables for lock management, contention reporting, time-out mechanism, etc.

3. Parallel Processing Parallel processing allows multiple batch runs / jobs to run in parallel to minimize the total elapsed batch processing time. This is not a problem as long as the jobs are not sharing the same files, db-tables or index spaces. If they do, this service should be implemented using partitioned data. Another option is to build an architecture module for maintaining interdependencies using a control table. A control table should contain a row for each shared resource and whether it is in use by an application or not. The batch architecture or the application in a parallel job would then retrieve information from that table to determine if it can get access to the resource it needs or not.

If the data access is not a problem, parallel processing can be implemented through the use of additional threads to process in parallel. In the mainframe environment, parallel job classes have traditionally been used, in order to ensure adequate CPU time for all the processes. Regardless, the solution has to be robust enough to ensure time slices for all the running processes.

Other key issues in parallel processing include load balancing and the availability of general system resources such as files, database buffer pools etc. Also note that the control table itself can easily become a critical resource.

4. Partitioning Using partitioning allows multiple versions of large batch applications to run concurrently. The purpose of this is to reduce the elapsed time required to process long batch jobs. Processes which can be successfully partitioned are those where the input file can be split and/or the main database tables partitioned to allow the application to run against different sets of data.

In addition, processes which are partitioned must be designed to only process their assigned data set. A partitioning architecture has to be closely tied to the database design and the database partitioning strategy. Please note, that the database partitioning doesn't necessarily mean physical partitioning of the database, although in most cases this is advisable. The following picture illustrates the partitioning approach:

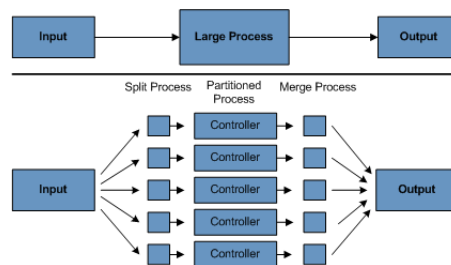

Figure 1.2: Partitioned Process

The architecture should be flexible enough to allow dynamic configuration of the number of partitions. Both automatic and user controlled configuration should be considered. Automatic configuration may be based on parameters such as the input file size and/or the number of input records.

4.1 Partitioning Approaches The following lists some of the possible partitioning approaches. Selecting a partitioning approach has to be done on a case-by-case basis.

1. Fixed and Even Break-Up of Record Set

This involves breaking the input record set into an even number of portions (e.g. 10, where each portion will have exactly 1/10th of the entire record set). Each portion is then processed by one instance of the batch/extract application.

In order to use this approach, preprocessing will be required to split the recordset up. The result of this split will be a lower and upper bound placement number which can be used as input to the batch/extract application in order to restrict its processing to its portion alone.

Preprocessing could be a large overhead as it has to calculate and determine the bounds of each portion of the record set.

2. Breakup by a Key Column

This involves breaking up the input record set by a key column such as a location code, and assigning data from each key to a batch instance. In order to achieve this, column values can either be

3. Assigned to a batch instance via a partitioning table (see below for details).

4. Assigned to a batch instance by a portion of the value (e.g. values 0000-0999, 1000 - 1999, etc.)

Under option 1, addition of new values will mean a manual reconfiguration of the batch/extract to ensure that the new value is added to a particular instance.

Under option 2, this will ensure that all values are covered via an instance of the batch job. However, the number of values processed by one instance is dependent on the distribution of column values (i.e. there may be a large number of locations in the 0000-0999 range, and few in the 1000-1999 range). Under this option, the data range should be designed with partitioning in mind.

Under both options, the optimal even distribution of records to batch instances cannot be realized. There is no dynamic configuration of the number of batch instances used.

5. Breakup by Views

This approach is basically breakup by a key column, but on the database level. It involves breaking up the recordset into views. These views will be used by each instance of the batch application during its processing. The breakup will be done by grouping the data.

With this option, each instance of a batch application will have to be configured to hit a particular view (instead of the master table). Also, with the addition of new data values, this new group of data will have to be included into a view. There is no dynamic configuration capability, as a change in the number of instances will result in a change to the views.

6. Addition of a Processing Indicator

This involves the addition of a new column to the input table, which acts as an indicator. As a preprocessing step, all indicators would be marked to non-processed. During the record fetch stage of the batch application, records are read on the condition that that record is marked non-processed, and once they are read (with lock), they are marked processing. When that record is completed, the indicator is updated to either complete or error. Many instances of a batch application can be started without a change, as the additional column ensures that a record is only processed once.

With this option, I/O on the table increases dynamically. In the case of an updating batch application, this impact is reduced, as a write will have to occur anyway.

7. Extract Table to a Flat File

This involves the extraction of the table into a file. This file can then be split into multiple segments and used as input to the batch instances.

With this option, the additional overhead of extracting the table into a file, and splitting it, may cancel out the effect of multi-partitioning. Dynamic configuration can be achieved via changing the file splitting script.

8. Use of a Hashing Column

This scheme involves the addition of a hash column (key/index) to the database tables used to retrieve the driver record. This hash column will have an indicator to determine which instance of the batch application will process this particular row. For example, if there are three batch instances to be started, then an indicator of 'A' will mark that row for processing by instance 1, an indicator of 'B' will mark that row for processing by instance 2, etc.

The procedure used to retrieve the records would then have an additional WHERE clause to select all rows marked by a particular indicator. The inserts in this table would involve the addition of the marker field, which would be defaulted to one of the instances (e.g. 'A').

A simple batch application would be used to update the indicators such as to redistribute the load between the different instances. When a sufficiently large number of new rows have been added, this batch can be run (anytime, except in the batch window) to redistribute the new rows to other instances.

Additional instances of the batch application only require the running of the batch application as above to redistribute the indicators to cater for a new number of instances.

4.2 Database and Application design Principles

An architecture that supports multi-partitioned applications which run against partitioned database tables using the key column approach, should include a central partition repository for storing partition parameters. This provides flexibility and ensures maintainability. The repository will generally consist of a single table known as the partition table.

Information stored in the partition table will be static and in general should be maintained by the DBA. The table should consist of one row of information for each partition of a multi-partitioned application. The table should have columns for: Program ID Code, Partition Number (Logical ID of the partition), Low Value of the db key column for this partition, High Value of the db key column for this partition.

On program start-up the program id and partition number should be passed to the application from the architecture (Control Processing Tasklet). These variables are used to read the partition table, to determine what range of data the application is to process (if a key column approach is used). In addition the partition number must be used throughout the processing to:

- Add to the output files/database updates in order for the merge process to work properly
- Report normal processing to the batch log and any errors that occur during execution to the architecture error handler

4.3 Minimizing Deadlocks

When applications run in parallel or partitioned, contention in database resources and deadlocks may occur. It is critical that the database design team eliminates potential contention situations as far as possible as part of the database design.

Also ensure that the database index tables are designed with deadlock prevention and performance in mind.

Deadlocks or hot spots often occur in administration or architecture tables such as log tables, control tables, and lock tables. The implications of these should be taken into account as well. A realistic stress test is crucial for identifying the possible bottlenecks in the architecture.

To minimize the impact of conflicts on data, the architecture should provide services such as wait-and-retry intervals when attaching to a database or when encountering a deadlock. This means a built-in mechanism to react to certain database return codes and instead of issuing an immediate error handling, waiting a predetermined amount of time and retrying the database operation.

4.4 Parameter Passing and Validation

The partition architecture should be relatively transparent to application developers. The architecture should perform all tasks associated with running the application in a partitioned mode including:

- Retrieve partition parameters before application start-up
- Validate partition parameters before application start-up
- Pass parameters to application at start-up

The validation should include checks to ensure that:

- the application has sufficient partitions to cover the whole data range
- there are no gaps between partitions

If the database is partitioned, some additional validation may be necessary to ensure that a single partition does not span database partitions.

Also the architecture should take into consideration the consolidation of partitions. Key questions include:

- Must all the partitions be finished before going into the next job step?
- What happens if one of the partitions aborts?

2. What's New in Spring Batch 3.0

The Spring Batch 3.0 release has five major themes:

- JSR-352 Support
- Upgrade to Support Spring 4 and Java 8
- Promote Spring Batch Integration to Spring Batch
- JobScope Support
- SQLite Support

2.1 JSR-352 Support

JSR-352 is the new java specification for batch processing. Heavily inspired by Spring Batch, this specification provides similar functionality to what Spring Batch already supports. However, Spring Batch 3.0 has implemented the specification and now supports the definition of batch jobs in compliance with the standard. An example of a batch job configured using JSR-352's Job Specification Language (JSL) would look like below:

```
<?xml version="1.0" encoding="UTF-8"?>
<job id="myJob3" xmlns="http://xmlns.jcp.org/xml/ns/javaee" version="1.0">
  <step id="step1" >
    <batchlet ref="testBatchlet" />
  </step>
</job>
```

See section JSR-352 Support for more details.

2.2 Promote Spring Batch Integration to Spring Batch

Spring Batch Integration has been a sub module of the Spring Batch Admin project now for a few years. It provides functionality to better integrate the capabilities provided in Spring Integration with Spring Batch. Specific functionality includes:

- Launching jobs via messages
- Asynchronous `ItemProcessors`
- Providing feedback with information messages
- Externalizing batch process execution via remote partitioning and remote chunking

See section Spring Batch Integration for details.

2.3 Upgrade to Support Spring 4 and Java 8

With the promotion of Spring Batch Integration to be a module of the Spring Batch project, it has been updated to use Spring Integration 4. Spring Integration 4 moves the core messaging APIs to Spring core. Because of this, Spring Batch 3 will now require Spring 4 or greater.

As part of the dependency updates that have occurred with this major release, Spring Batch now supports being run on Java 8. It will still execute on Java 6 or higher as well.

2.4 JobScope Support

The Spring scope "step" used in Spring Batch has had a pivotal role in batch applications, providing late binding functionality for a long time now. With the 3.0 release Spring Batch now supports a "job" scope. This new scope allows for the delayed construction of objects until a Job is actually launched as well as providing a facility for new instances for each execution of a job. You can read the details about this new bean scope in the section the section called "Job Scope".

2.5 SQLite Support

SQLite has been added as a newly supported database option for the `JobRepository` by adding job repository ddl for SQLite. This provides a useful, file based, data store for testing purposes.

3. The Domain Language of Batch

To any experienced batch architect, the overall concepts of batch processing used in Spring Batch should be familiar and comfortable. There are "Jobs" and "Steps" and developer supplied processing units called ItemReaders and ItemWriters. However, because of the Spring patterns, operations, templates, callbacks, and idioms, there are opportunities for the following:

- significant improvement in adherence to a clear separation of concerns
- clearly delineated architectural layers and services provided as interfaces
- simple and default implementations that allow for quick adoption and ease of use out-of-the-box
- significantly enhanced extensibility

The diagram below is simplified version of the batch reference architecture that has been used for decades. It provides an overview of the components that make up the domain language of batch processing. This architecture framework is a blueprint that has been proven through decades of implementations on the last several generations of platforms (COBOL/Mainframe, C++/Unix, and now Java/anywhere). JCL and COBOL developers are likely to be as comfortable with the concepts as C++, C# and Java developers. Spring Batch provides a physical implementation of the layers, components and technical services commonly found in robust, maintainable systems used to address the creation of simple to complex batch applications, with the infrastructure and extensions to address very complex processing needs.

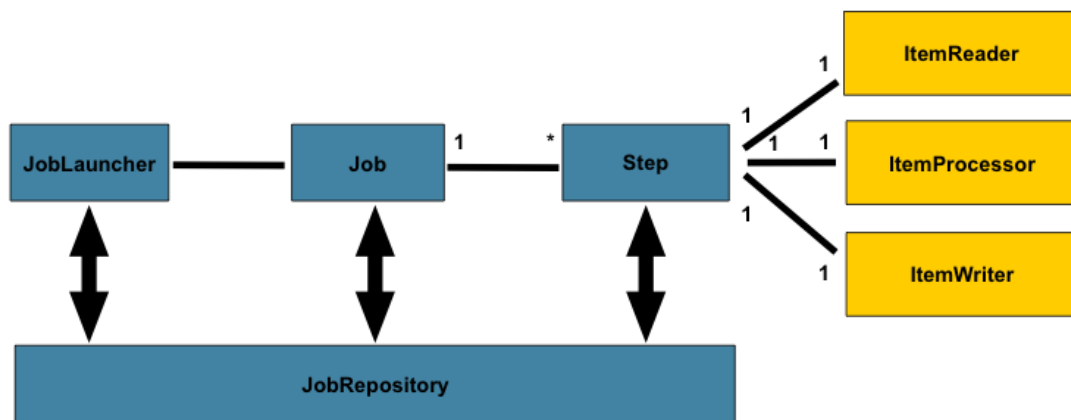
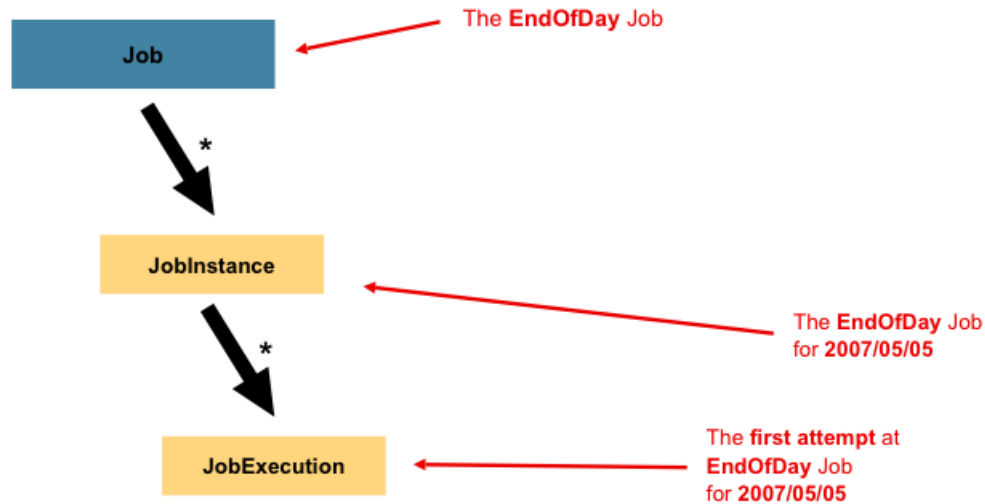

Figure 2.1: Batch Stereotypes

The diagram above highlights the key concepts that make up the domain language of batch. A Job has one to many steps, which has exactly one ItemReader, ItemProcessor, and ItemWriter. A job needs to be launched (JobLauncher), and meta data about the currently running process needs to be stored (JobRepository).

3.1 Job

This section describes stereotypes relating to the concept of a batch job. A Job is an entity that encapsulates an entire batch process. As is common with other Spring projects, a Job will be wired together via an XML configuration file or Java based configuration. This configuration may be referred to as the "job configuration". However, Job is just the top of an overall hierarchy:



In Spring Batch, a Job is simply a container for Steps. It combines multiple steps that belong logically together in a flow and allows for configuration of properties global to all steps, such as restartability. The job configuration contains:

- The simple name of the job
- Definition and ordering of Steps
- Whether or not the job is restartable

A default simple implementation of the `Job` interface is provided by Spring Batch in the form of the `SimpleJob` class which creates some standard functionality on top of `Job`, however the batch namespace abstracts away the need to instantiate it directly. Instead, the `<job>` tag can be used:

```

<job id="footballJob">
  <step id="playerload" next="gameLoad"/>
  <step id="gameLoad" next="playerSummarization"/>
  <step id="playerSummarization"/>
</job>
  
```

JobInstance

A `JobInstance` refers to the concept of a logical job run. Let's consider a batch job that should be run once at the end of the day, such as the 'EndOfDay' job from the diagram above. There is one 'EndOfDay' `Job`, but each individual run of the `Job` must be tracked separately. In the case of this job, there will be one logical `JobInstance` per day. For example, there will be a January 1st run, and a January 2nd run. If the January 1st run fails the first time and is run again the next day, it is still the January 1st run. (Usually this corresponds with the data it is processing as well, meaning the January 1st run processes data for January 1st, etc). Therefore, each `JobInstance` can have multiple executions (`JobExecution` is discussed in more detail below) and only one `JobInstance` corresponding to a particular `Job` and identifying `JobParameters` can be running at a given time.

The definition of a `JobInstance` has absolutely no bearing on the data that will be loaded. It is entirely up to the `ItemReader` implementation used to determine how data will be loaded. For example, in the EndOfDay scenario, there may be a column on the data that indicates the 'effective date' or 'schedule date' to which the data belongs. So, the January 1st run would only load data from the 1st, and the January 2nd run would only use data from the 2nd. Because this determination will likely be a business

decision, it is left up to the `ItemReader` to decide. What using the same `JobInstance` will determine, however, is whether or not the 'state' (i.e. the `ExecutionContext`, which is discussed below) from previous executions will be used. Using a new `JobInstance` will mean 'start from the beginning' and using an existing instance will generally mean 'start from where you left off'.

JobParameters

Having discussed `JobInstance` and how it differs from `Job`, the natural question to ask is: "how is one `JobInstance` distinguished from another?" The answer is: `JobParameters`. `JobParameters` is a set of parameters used to start a batch job. They can be used for identification or even as reference data during the run:

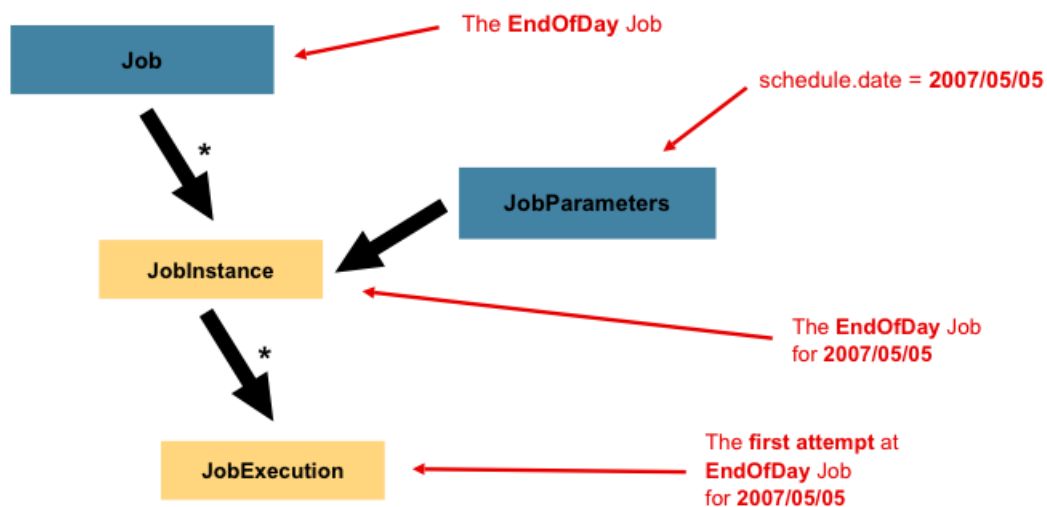

In the example above, where there are two instances, one for January 1st, and another for January 2nd, there is really only one `Job`, one that was started with a job parameter of 01-01-2008 and another that was started with a parameter of 01-02-2008. Thus, the contract can be defined as: `JobInstance = Job + identifying JobParameters`. This allows a developer to effectively control how a `JobInstance` is defined, since they control what parameters are passed in.

Note

Not all job parameters are required to contribute to the identification of a `JobInstance`. By default they do, however the framework allows the submission of a `Job` with parameters that do not contribute to the identity of a `JobInstance` as well.

JobExecution

A `JobExecution` refers to the technical concept of a single attempt to run a `Job`. An execution may end in failure or success, but the `JobInstance` corresponding to a given execution will not be considered complete unless the execution completes successfully. Using the `EndOfDay Job` described above as an example, consider a `JobInstance` for 01-01-2008 that failed the first time it was run. If it is run again with the same identifying job parameters as the first run (01-01-2008), a new `JobExecution` will be created. However, there will still be only one `JobInstance`.

A `Job` defines what a job is and how it is to be executed, and `JobInstance` is a purely organizational object to group executions together, primarily to enable correct restart semantics. A `JobExecution`,

however, is the primary storage mechanism for what actually happened during a run, and as such contains many more properties that must be controlled and persisted:

Table 3.1. JobExecution Properties

status	A <code>BatchStatus</code> object that indicates the status of the execution. While running, it's <code>BatchStatus.STARTED</code> , if it fails, it's <code>BatchStatus.FAILED</code> , and if it finishes successfully, it's <code>BatchStatus.COMPLETED</code>
startTime	A <code>java.util.Date</code> representing the current system time when the execution was started.
endTime	A <code>java.util.Date</code> representing the current system time when the execution finished, regardless of whether or not it was successful.
exitStatus	The <code>ExitStatus</code> indicating the result of the run. It is most important because it contains an exit code that will be returned to the caller. See chapter 5 for more details.
createTime	A <code>java.util.Date</code> representing the current system time when the <code>JobExecution</code> was first persisted. The job may not have been started yet (and thus has no start time), but it will always have a <code>createTime</code> , which is required by the framework for managing job level <code>ExecutionContexts</code> .
lastUpdated	A <code>java.util.Date</code> representing the last time a <code>JobExecution</code> was persisted.
executionContext	The 'property bag' containing any user data that needs to be persisted between executions.
failureExceptions	The list of exceptions encountered during the execution of a <code>Job</code> . These can be useful if more than one exception is encountered during the failure of a <code>Job</code> .

These properties are important because they will be persisted and can be used to completely determine the status of an execution. For example, if the `EndOfDay` job for 01-01 is executed at 9:00 PM, and fails at 9:30, the following entries will be made in the batch meta data tables:

Table 3.2. BATCH_JOB_INSTANCE

JOB_INST_ID	JOB_NAME
1	EndOfDayJob

Table 3.3. BATCH_JOB_EXECUTION_PARAMS

JOB_EXECUTION_ID	IDTYPE_CD	KEY_NAME	DATE_VAL	IDENTIFYING
1	DATE	schedule.Date	2008-01-01	TRUE

Table 3.4. BATCH_JOB_EXECUTION

JOB_EXEC_ID	JOB_INST_ID	START_TIME	END_TIME	STATUS
1	1	2008-01-01 21:00	2008-01-01 21:30	FAILED

Note

column names may have been abbreviated or removed for clarity and formatting

Now that the job has failed, let's assume that it took the entire course of the night for the problem to be determined, so that the 'batch window' is now closed. Assuming the window starts at 9:00 PM, the job will be kicked off again for 01-01, starting where it left off and completing successfully at 9:30. Because it's now the next day, the 01-02 job must be run as well, which is kicked off just afterwards at 9:31, and completes in its normal one hour time at 10:30. There is no requirement that one `JobInstance` be kicked off after another, unless there is potential for the two jobs to attempt to access the same data, causing issues with locking at the database level. It is entirely up to the scheduler to determine when a `Job` should be run. Since they're separate `JobInstances`, Spring Batch will make no attempt to stop them from being run concurrently. (Attempting to run the same `JobInstance` while another is already running will result in a `JobExecutionAlreadyRunningException` being thrown). There should now be an extra entry in both the `JobInstance` and `JobParameters` tables, and two extra entries in the `JobExecution` table:

Table 3.5. `BATCH_JOB_INSTANCE`

JOB_INST_ID	JOB_NAME
1	EndOfDayJob
2	EndOfDayJob

Table 3.6. `BATCH_JOB_EXECUTION_PARAMS`

JOB_EXECUTION_ID	IDTYPE_CD	KEY_NAME	DATE_VAL	IDENTIFYING
1	DATE	schedule.Date	2008-01-01 00:00:00	TRUE
2	DATE	schedule.Date	2008-01-01 00:00:00	TRUE
3	DATE	schedule.Date	2008-01-02 00:00:00	TRUE

Table 3.7. `BATCH_JOB_EXECUTION`

JOB_EXEC_ID	JOB_INST_ID	START_TIME	END_TIME	STATUS
1	1	2008-01-01 21:00	2008-01-01 21:30	FAILED
2	1	2008-01-02 21:00	2008-01-02 21:30	COMPLETED
3	2	2008-01-02 21:31	2008-01-02 22:29	COMPLETED

Note

column names may have been abbreviated or removed for clarity and formatting

3.2 Step

A `Step` is a domain object that encapsulates an independent, sequential phase of a batch job. Therefore, every `Job` is composed entirely of one or more steps. A `Step` contains all of the information necessary to define and control the actual batch processing. This is a necessarily vague description because the contents of any given `Step` are at the discretion of the developer writing a `Job`. A `Step` can be as simple or complex as the developer desires. A simple `Step` might load data from a file into the database,

requiring little or no code. (depending upon the implementations used) A more complex `Step` may have complicated business rules that are applied as part of the processing. As with `Job`, a `Step` has an individual `StepExecution` that corresponds with a unique `JobExecution`:

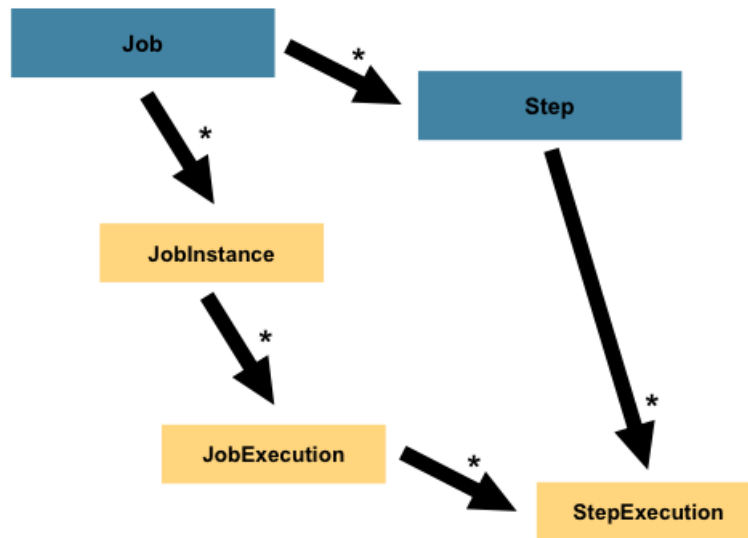

StepExecution

A `StepExecution` represents a single attempt to execute a `Step`. A new `StepExecution` will be created each time a `Step` is run, similar to `JobExecution`. However, if a step fails to execute because the step before it fails, there will be no execution persisted for it. A `StepExecution` will only be created when its `Step` is actually started.

Step executions are represented by objects of the `StepExecution` class. Each execution contains a reference to its corresponding step and `JobExecution`, and transaction related data such as commit and rollback count and start and end times. Additionally, each step execution will contain an `ExecutionContext`, which contains any data a developer needs persisted across batch runs, such as statistics or state information needed to restart. The following is a listing of the properties for `StepExecution`:

Table 3.8. *StepExecution Properties*

status	A <code>BatchStatus</code> object that indicates the status of the execution. While it's running, the status is <code>BatchStatus.STARTED</code> , if it fails, the status is <code>BatchStatus.FAILED</code> , and if it finishes successfully, the status is <code>BatchStatus.COMPLETED</code>
startTime	A <code>java.util.Date</code> representing the current system time when the execution was started.
endTime	A <code>java.util.Date</code> representing the current system time when the execution finished, regardless of whether or not it was successful.
exitStatus	The <code>ExitStatus</code> indicating the result of the execution. It is most important because it contains an exit code that will be returned to the caller. See chapter 5 for more details.
executionContext	The 'property bag' containing any user data that needs to be persisted between executions.

readCount	The number of items that have been successfully read
writeCount	The number of items that have been successfully written
commitCount	The number transactions that have been committed for this execution
rollbackCount	The number of times the business transaction controlled by the <code>Step</code> has been rolled back.
readSkipCount	The number of times <code>read</code> has failed, resulting in a skipped item.
processSkipCount	The number of times <code>process</code> has failed, resulting in a skipped item.
filterCount	The number of items that have been 'filtered' by the <code>ItemProcessor</code> .
writeSkipCount	The number of times <code>write</code> has failed, resulting in a skipped item.

3.3 ExecutionContext

An `ExecutionContext` represents a collection of key/value pairs that are persisted and controlled by the framework in order to allow developers a place to store persistent state that is scoped to a `StepExecution` or `JobExecution`. For those familiar with Quartz, it is very similar to `JobDataMap`. The best usage example is to facilitate restart. Using flat file input as an example, while processing individual lines, the framework periodically persists the `ExecutionContext` at commit points. This allows the `ItemReader` to store its state in case a fatal error occurs during the run, or even if the power goes out. All that is needed is to put the current number of lines read into the context, and the framework will do the rest:

```
executionContext.putLong(getKey(LINES_READ_COUNT), reader.getPosition());
```

Using the `EndOfDay` example from the Job Stereotypes section as an example, assume there's one step: 'loadData', that loads a file into the database. After the first failed run, the meta data tables would look like the following:

Table 3.9. BATCH_JOB_INSTANCE

JOB_INST_ID	JOB_NAME
1	EndOfDayJob

Table 3.10. BATCH_JOB_PARAMS

JOB_INST_ID	TYPE_CD	KEY_NAME	DATE_VAL
1	DATE	schedule.Date	2008-01-01

Table 3.11. BATCH_JOB_EXECUTION

JOB_EXEC_ID	JOB_INST_ID	START_TIME	END_TIME	STATUS
1	1	2008-01-01 21:00	2008-01-01 21:30	FAILED

Table 3.12. BATCH_STEP_EXECUTION

STEP_EXEC_ID	JOB_EXEC_ID	STEP_NAME	START_TIME	END_TIME	STATUS
--------------	-------------	-----------	------------	----------	--------

1	1	loadDate	2008-01-01 21:00	2008-01-01 21:30	FAILED
---	---	----------	---------------------	---------------------	--------

Table 3.13. BATCH_STEP_EXECUTION_CONTEXT

STEP_EXEC_ID	SHORT_CONTEXT
1	{piece.count=40321}

In this case, the `Step` ran for 30 minutes and processed 40,321 'pieces', which would represent lines in a file in this scenario. This value will be updated just before each commit by the framework, and can contain multiple rows corresponding to entries within the `ExecutionContext`. Being notified before a commit requires one of the various `StepListeners`, or an `ItemStream`, which are discussed in more detail later in this guide. As with the previous example, it is assumed that the `Job` is restarted the next day. When it is restarted, the values from the `ExecutionContext` of the last run are reconstituted from the database, and when the `ItemReader` is opened, it can check to see if it has any stored state in the context, and initialize itself from there:

```
if (executionContext.containsKey(getKey(LINES_READ_COUNT))) {
    log.debug("Initializing for restart. Restart data is: " + executionContext);

    long lineCount = executionContext.getLong(getKey(LINES_READ_COUNT));

    LineReader reader = getReader();

    Object record = "";
    while (reader.getPosition() < lineCount && record != null) {
        record = readLine();
    }
}
```

In this case, after the above code is executed, the current line will be 40,322, allowing the `Step` to start again from where it left off. The `ExecutionContext` can also be used for statistics that need to be persisted about the run itself. For example, if a flat file contains orders for processing that exist across multiple lines, it may be necessary to store how many orders have been processed (which is much different from than the number of lines read) so that an email can be sent at the end of the `Step` with the total orders processed in the body. The framework handles storing this for the developer, in order to correctly scope it with an individual `JobInstance`. It can be very difficult to know whether an existing `ExecutionContext` should be used or not. For example, using the 'EndOfDay' example from above, when the 01-01 run starts again for the second time, the framework recognizes that it is the same `JobInstance` and on an individual `Step` basis, pulls the `ExecutionContext` out of the database and hands it as part of the `StepExecution` to the `Step` itself. Conversely, for the 01-02 run the framework recognizes that it is a different instance, so an empty context must be handed to the `Step`. There are many of these types of determinations that the framework makes for the developer to ensure the state is given to them at the correct time. It is also important to note that exactly one `ExecutionContext` exists per `StepExecution` at any given time. Clients of the `ExecutionContext` should be careful because this creates a shared key space, so care should be taken when putting values in to ensure no data is overwritten. However, the `Step` stores absolutely no data in the context, so there is no way to adversely affect the framework.

It is also important to note that there is at least one `ExecutionContext` per `JobExecution`, and one for every `StepExecution`. For example, consider the following code snippet:

```
ExecutionContext ecStep = stepExecution.getExecutionContext();
ExecutionContext ecJob = jobExecution.getExecutionContext();
//ecStep does not equal ecJob
```

As noted in the comment, `ecStep` will not equal `ecJob`; they are two different `ExecutionContexts`. The one scoped to the `Step` will be saved at every commit point in the `Step`, whereas the one scoped to the `Job` will be saved in between every `Step` execution.

3.4 JobRepository

`JobRepository` is the persistence mechanism for all of the Stereotypes mentioned above. It provides CRUD operations for `JobLauncher`, `Job`, and `Step` implementations. When a `Job` is first launched, a `JobExecution` is obtained from the repository, and during the course of execution `StepExecution` and `JobExecution` implementations are persisted by passing them to the repository:

```
<job-repository id="jobRepository"/>
```

3.5 JobLauncher

`JobLauncher` represents a simple interface for launching a `Job` with a given set of `JobParameters`:

```
public interface JobLauncher {
    public JobExecution run(Job job, JobParameters jobParameters)
        throws JobExecutionAlreadyRunningException, JobRestartException;
}
```

It is expected that implementations will obtain a valid `JobExecution` from the `JobRepository` and execute the `Job`.

3.6 Item Reader

`ItemReader` is an abstraction that represents the retrieval of input for a `Step`, one item at a time. When the `ItemReader` has exhausted the items it can provide, it will indicate this by returning null. More details about the `ItemReader` interface and its various implementations can be found in Chapter 6, *ItemReaders and ItemWriters*.

3.7 Item Writer

`ItemWriter` is an abstraction that represents the output of a `Step`, one batch or chunk of items at a time. Generally, an item writer has no knowledge of the input it will receive next, only the item that was passed in its current invocation. More details about the `ItemWriter` interface and its various implementations can be found in Chapter 6, *ItemReaders and ItemWriters*.

3.8 Item Processor

`ItemProcessor` is an abstraction that represents the business processing of an item. While the `ItemReader` reads one item, and the `ItemWriter` writes them, the `ItemProcessor` provides access to transform or apply other business processing. If, while processing the item, it is determined that the item is not valid, returning null indicates that the item should not be written out. More details about the `ItemProcessor` interface can be found in Chapter 6, *ItemReaders and ItemWriters*.

3.9 Batch Namespace

Many of the domain concepts listed above need to be configured in a Spring `ApplicationContext`. While there are implementations of the interfaces above that can be used in a standard bean definition, a namespace has been provided for ease of configuration:

```
<beans:beans xmlns="http://www.springframework.org/schema/batch"
  xmlns:beans="http://www.springframework.org/schema/beans"
  xmlns:xsi="http://www.w3.org/2001/XMLSchema-instance"
  xsi:schemaLocation="
    http://www.springframework.org/schema/beans
    http://www.springframework.org/schema/beans/spring-beans.xsd
    http://www.springframework.org/schema/batch
    http://www.springframework.org/schema/batch/spring-batch-2.2.xsd">

  <job id="ioSampleJob">
    <step id="step1">
      <tasklet>
        <chunk reader="itemReader" writer="itemWriter" commit-interval="2"/>
      </tasklet>
    </step>
  </job>

</beans:beans>
```

As long as the batch namespace has been declared, any of its elements can be used. More information on configuring a `Job` can be found in Chapter 4, *Configuring and Running a Job*. More information on configuring a `Step` can be found in Chapter 5, *Configuring a Step*.

4. Configuring and Running a Job

In the [domain section](#), the overall architecture design was discussed, using the following diagram as a guide:

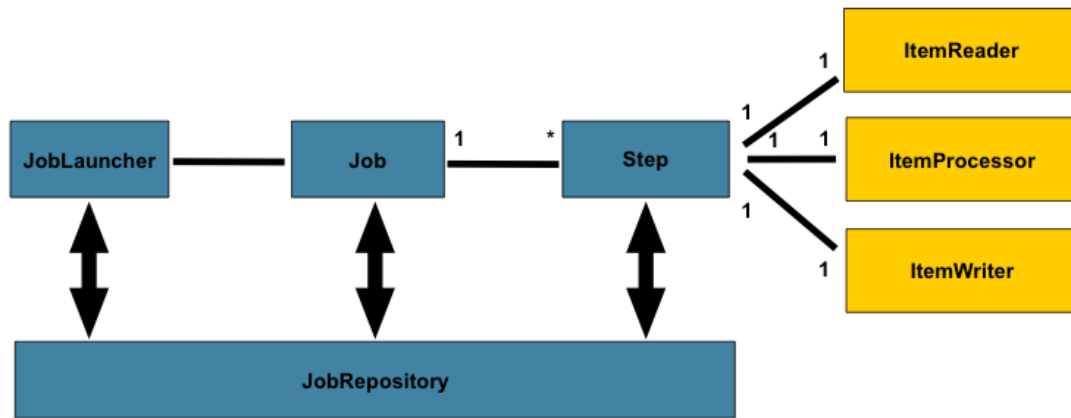

While the `Job` object may seem like a simple container for steps, there are many configuration options of which a developers must be aware. Furthermore, there are many considerations for how a `Job` will be run and how its meta-data will be stored during that run. This chapter will explain the various configuration options and runtime concerns of a `Job`.

4.1 Configuring a Job

There are multiple implementations of the `Job` interface, however, the namespace abstracts away the differences in configuration. It has only three required dependencies: a name, `JobRepository`, and a list of `Steps`.

```

<job id="footballJob">
  <step id="playerload" parent="s1" next="gameLoad"/>
  <step id="gameLoad" parent="s2" next="playerSummarization"/>
  <step id="playerSummarization" parent="s3"/>
</job>
  
```

The examples here use a parent bean definition to create the steps; see the section on [step configuration](#) for more options declaring specific step details inline. The XML namespace defaults to referencing a repository with an id of 'jobRepository', which is a sensible default. However, this can be overridden explicitly:

```

<job id="footballJob" job-repository="specialRepository">
  <step id="playerload" parent="s1" next="gameLoad"/>
  <step id="gameLoad" parent="s3" next="playerSummarization"/>
  <step id="playerSummarization" parent="s3"/>
</job>
  
```

In addition to steps a job configuration can contain other elements that help with parallelisation (`<split/>`), declarative flow control (`<decision/>`) and externalization of flow definitions (`<flow/>`).

Restartability

One key issue when executing a batch job concerns the behavior of a `Job` when it is restarted. The launching of a `Job` is considered to be a 'restart' if a `JobExecution` already exists for the particular `JobInstance`. Ideally, all jobs should be able to start up where they left off, but there are scenarios

where this is not possible. **It is entirely up to the developer to ensure that a new `JobInstance` is created in this scenario.** However, Spring Batch does provide some help. If a `Job` should never be restarted, but should always be run as part of a new `JobInstance`, then the `restartable` property may be set to 'false':

```
<job id="footballJob" restartable="false">
  ...
</job>
```

To phrase it another way, setting `restartable` to false means "this `Job` does not support being started again". Restarting a `Job` that is not restartable will cause a `JobRestartException` to be thrown:

```
Job job = new SimpleJob();
job.setRestartable(false);

JobParameters jobParameters = new JobParameters();

JobExecution firstExecution = jobRepository.createJobExecution(job, jobParameters);
jobRepository.saveOrUpdate(firstExecution);

try {
    jobRepository.createJobExecution(job, jobParameters);
    fail();
}
catch (JobRestartException e) {
    // expected
}
```

This snippet of JUnit code shows how attempting to create a `JobExecution` the first time for a non restartable `job` will cause no issues. However, the second attempt will throw a `JobRestartException`.

Intercepting Job Execution

During the course of the execution of a `Job`, it may be useful to be notified of various events in its lifecycle so that custom code may be executed. The `SimpleJob` allows for this by calling a `JobListener` at the appropriate time:

```
public interface JobExecutionListener {

    void beforeJob(JobExecution jobExecution);

    void afterJob(JobExecution jobExecution);

}
```

`JobListeners` can be added to a `SimpleJob` via the `listeners` element on the `job`:

```
<job id="footballJob">
  <step id="playerload"          parent="s1" next="gameLoad"/>
  <step id="gameLoad"           parent="s2" next="playerSummarization"/>
  <step id="playerSummarization" parent="s3"/>
  <listeners>
    <listener ref="sampleListener"/>
  </listeners>
</job>
```

It should be noted that `afterJob` will be called regardless of the success or failure of the `Job`. If success or failure needs to be determined it can be obtained from the `JobExecution`:

```

public void afterJob(JobExecution jobExecution){
    if( jobExecution.getStatus() == BatchStatus.COMPLETED ){
        //job success
    }
    else if(jobExecution.getStatus() == BatchStatus.FAILED){
        //job failure
    }
}

```

The annotations corresponding to this interface are:

- @BeforeJob
- @AfterJob

Inheriting from a Parent Job

If a group of `Jobs` share similar, but not identical, configurations, then it may be helpful to define a "parent" `Job` from which the concrete `Jobs` may inherit properties. Similar to class inheritance in Java, the "child" `Job` will combine its elements and attributes with the parent's.

In the following example, "baseJob" is an abstract `Job` definition that defines only a list of listeners. The `Job` "job1" is a concrete definition that inherits the list of listeners from "baseJob" and merges it with its own list of listeners to produce a `Job` with two listeners and one `Step`, "step1".

```

<job id="baseJob" abstract="true">
  <listeners>
    <listener ref="listenerOne"/>
  </listeners>
</job>

<job id="job1" parent="baseJob">
  <step id="step1" parent="standaloneStep"/>

  <listeners merge="true">
    <listener ref="listenerTwo"/>
  </listeners>
</job>

```

Please see the section on [Inheriting from a Parent Step](#) for more detailed information.

JobParametersValidator

A job declared in the XML namespace or using any subclass of `AbstractJob` can optionally declare a validator for the job parameters at runtime. This is useful when for instance you need to assert that a job is started with all its mandatory parameters. There is a `DefaultJobParametersValidator` that can be used to constrain combinations of simple mandatory and optional parameters, and for more complex constraints you can implement the interface yourself. The configuration of a validator is supported through the XML namespace through a child element of the job, e.g:

```

<job id="job1" parent="baseJob3">
  <step id="step1" parent="standaloneStep"/>
  <validator ref="parametersValidator"/>
</job>

```

The validator can be specified as a reference (as above) or as a nested bean definition in the beans namespace.

4.2 Java Config

Spring 3 brought the ability to configure applications via java instead of XML. As of Spring Batch 2.2.0, batch jobs can be configured using the same java config. There are two components for the java based configuration: the `@EnableBatchConfiguration` annotation and two builders.

The `@EnableBatchProcessing` works similarly to the other `@Enable*` annotations in the Spring family. In this case, `@EnableBatchProcessing` provides a base configuration for building batch jobs. Within this base configuration, an instance of `StepScope` is created in addition to a number of beans made available to be autowired:

- `JobRepository` - bean name "jobRepository"
- `JobLauncher` - bean name "jobLauncher"
- `JobRegistry` - bean name "jobRegistry"
- `PlatformTransactionManager` - bean name "transactionManager"
- `JobBuilderFactory` - bean name "jobBuilders"
- `StepBuilderFactory` - bean name "stepBuilders"

The core interface for this configuration is the `BatchConfigurer`. The default implementation provides the beans mentioned above and requires a `DataSource` as a bean within the context to be provided. This data source will be used by the `JobRepository`.

Note

Only one configuration class needs to have the `@EnableBatchProcessing` annotation. Once you have a class annotated with it, you will have all of the above available.

With the base configuration in place, a user can use the provided builder factories to configure a job. Below is an example of a two step job configured via the `JobBuilderFactory` and the `StepBuilderFactory`.

```

@Configuration
@EnableBatchProcessing
@Import(DataSourceConfiguration.class)
public class AppConfig {

    @Autowired
    private JobBuilderFactory jobs;

    @Autowired
    private StepBuilderFactory steps;

    @Bean
    public Job job(@Qualifier("step1") Step step1, @Qualifier("step2") Step step2) {
        return jobs.get("myJob").start(step1).next(step2).build();
    }

    @Bean
    protected Step step1(ItemReader<Person> reader, ItemProcessor<Person, Person> processor,
ItemWriter<Person> writer) {
        return steps.get("step1")
            .<Person, Person> chunk(10)
            .reader(reader)
            .processor(processor)
            .writer(writer)
            .build();
    }

    @Bean
    protected Step step2(Tasklet tasklet) {
        return steps.get("step2")
            .tasklet(tasklet)
            .build();
    }
}

```

4.3 Configuring a JobRepository

As described in earlier, the [JobRepository](#) is used for basic CRUD operations of the various persisted domain objects within Spring Batch, such as `JobExecution` and `StepExecution`. It is required by many of the major framework features, such as the `JobLauncher`, `Job`, and `Step`. The batch namespace abstracts away many of the implementation details of the `JobRepository` implementations and their collaborators. However, there are still a few configuration options available:

```

<job-repository id="jobRepository"
    data-source="dataSource"
    transaction-manager="transactionManager"
    isolation-level-for-create="SERIALIZABLE"
    table-prefix="BATCH_"
    max-varchar-length="1000"/>

```

None of the configuration options listed above are required except the id. If they are not set, the defaults shown above will be used. They are shown above for awareness purposes. The `max-varchar-length` defaults to 2500, which is the length of the long `VARCHAR` columns in the [sample schema scripts](#) used to store things like exit code descriptions. If you don't modify the schema and you don't use multi-byte characters you shouldn't need to change it.

Transaction Configuration for the JobRepository

If the namespace is used, transactional advice will be automatically created around the repository. This is to ensure that the batch meta data, including state that is necessary for restarts after a failure, is persisted correctly. The behavior of the framework is not well defined if the repository methods are not transactional. The isolation level in the `create*` method attributes is specified separately to ensure that

when jobs are launched, if two processes are trying to launch the same job at the same time, only one will succeed. The default isolation level for that method is `SERIALIZABLE`, which is quite aggressive: `READ_COMMITTED` would work just as well; `READ_UNCOMMITTED` would be fine if two processes are not likely to collide in this way. However, since a call to the `create*` method is quite short, it is unlikely that the `SERIALIZED` will cause problems, as long as the database platform supports it. However, this can be overridden:

```
<job-repository id="jobRepository"
    isolation-level-for-create="REPEATABLE_READ" />
```

If the namespace or factory beans aren't used then it is also essential to configure the transactional behavior of the repository using AOP:

```
<aop:config>
  <aop:advisor
    pointcut="execution(* org.springframework.batch.core.*Repository+.*(..))"/>
    <advice-ref="txAdvice" />
  </aop:advisor>
</aop:config>

<tx:advice id="txAdvice" transaction-manager="transactionManager">
  <tx:attributes>
    <tx:method name="*" />
  </tx:attributes>
</tx:advice>
```

This fragment can be used as is, with almost no changes. Remember also to include the appropriate namespace declarations and to make sure `spring-tx` and `spring-aop` (or the whole of `spring`) are on the classpath.

Changing the Table Prefix

Another modifiable property of the `JobRepository` is the table prefix of the meta-data tables. By default they are all prefaced with `BATCH_`. `BATCH_JOB_EXECUTION` and `BATCH_STEP_EXECUTION` are two examples. However, there are potential reasons to modify this prefix. If the schema names needs to be prepended to the table names, or if more than one set of meta data tables is needed within the same schema, then the table prefix will need to be changed:

```
<job-repository id="jobRepository"
    table-prefix="SYSTEM.TEST_" />
```

Given the above changes, every query to the meta data tables will be prefixed with `"SYSTEM.TEST_"`. `BATCH_JOB_EXECUTION` will be referred to as `SYSTEM.TEST_JOB_EXECUTION`.

Note

Only the table prefix is configurable. The table and column names are not.

In-Memory Repository

There are scenarios in which you may not want to persist your domain objects to the database. One reason may be speed; storing domain objects at each commit point takes extra time. Another reason may be that you just don't need to persist status for a particular job. For this reason, Spring batch provides an in-memory `Map` version of the job repository:

```
<bean id="jobRepository"
  class="org.springframework.batch.core.repository.support.MapJobRepositoryFactoryBean">
  <property name="transactionManager" ref="transactionManager"/>
</bean>
```

Note that the in-memory repository is volatile and so does not allow restart between JVM instances. It also cannot guarantee that two job instances with the same parameters are launched simultaneously, and is not suitable for use in a multi-threaded Job, or a locally partitioned Step. So use the database version of the repository wherever you need those features.

However it does require a transaction manager to be defined because there are rollback semantics within the repository, and because the business logic might still be transactional (e.g. RDBMS access). For testing purposes many people find the `ResourcelessTransactionManager` useful.

Non-standard Database Types in a Repository

If you are using a database platform that is not in the list of supported platforms, you may be able to use one of the supported types, if the SQL variant is close enough. To do this you can use the raw `JobRepositoryFactoryBean` instead of the namespace shortcut and use it to set the database type to the closest match:

```
<bean id="jobRepository" class="org...JobRepositoryFactoryBean">
  <property name="databaseType" value="db2"/>
  <property name="dataSource" ref="dataSource"/>
</bean>
```

(The `JobRepositoryFactoryBean` tries to auto-detect the database type from the `DataSource` if it is not specified.) The major differences between platforms are mainly accounted for by the strategy for incrementing primary keys, so often it might be necessary to override the `incrementerFactory` as well (using one of the standard implementations from the Spring Framework).

If even that doesn't work, or you are not using an RDBMS, then the only option may be to implement the various `Dao` interfaces that the `SimpleJobRepository` depends on and wire one up manually in the normal Spring way.

4.4 Configuring a JobLauncher

The most basic implementation of the `JobLauncher` interface is the `SimpleJobLauncher`. Its only required dependency is a `JobRepository`, in order to obtain an execution:

```
<bean id="jobLauncher"
  class="org.springframework.batch.core.launch.support.SimpleJobLauncher">
  <property name="jobRepository" ref="jobRepository" />
</bean>
```

Once a `JobExecution` is obtained, it is passed to the `execute` method of `Job`, ultimately returning the `JobExecution` to the caller:

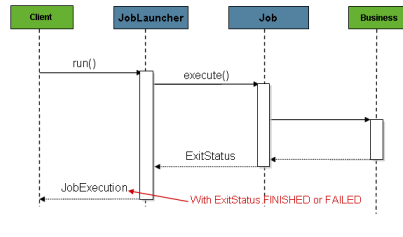

The sequence is straightforward and works well when launched from a scheduler. However, issues arise when trying to launch from an HTTP request. In this scenario, the launching needs to be done asynchronously so that the `SimpleJobLauncher` returns immediately to its caller. This is because it is not good practice to keep an HTTP request open for the amount of time needed by long running processes such as batch. An example sequence is below:

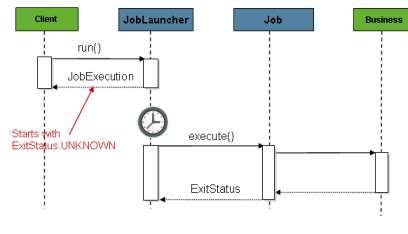

The `SimpleJobLauncher` can easily be configured to allow for this scenario by configuring a `TaskExecutor`:

```

<bean id="jobLauncher"
    class="org.springframework.batch.core.launch.support.SimpleJobLauncher">
    <property name="jobRepository" ref="jobRepository" />
    <property name="taskExecutor">
        <bean class="org.springframework.core.task.SimpleAsyncTaskExecutor" />
    </property>
</bean>
  
```

Any implementation of the spring `TaskExecutor` interface can be used to control how jobs are asynchronously executed.

4.5 Running a Job

At a minimum, launching a batch job requires two things: the `Job` to be launched and a `JobLauncher`. Both can be contained within the same context or different contexts. For example, if launching a job from the command line, a new JVM will be instantiated for each `Job`, and thus every job will have its own `JobLauncher`. However, if running from within a web container within the scope of an `HttpRequest`, there will usually be one `JobLauncher`, configured for asynchronous job launching, that multiple requests will invoke to launch their jobs.

Running Jobs from the Command Line

For users that want to run their jobs from an enterprise scheduler, the command line is the primary interface. This is because most schedulers (with the exception of Quartz unless using the `NativeJob`)

work directly with operating system processes, primarily kicked off with shell scripts. There are many ways to launch a Java process besides a shell script, such as Perl, Ruby, or even 'build tools' such as ant or maven. However, because most people are familiar with shell scripts, this example will focus on them.

The CommandLineJobRunner

Because the script launching the job must kick off a Java Virtual Machine, there needs to be a class with a main method to act as the primary entry point. Spring Batch provides an implementation that serves just this purpose: `CommandLineJobRunner`. It's important to note that this is just one way to bootstrap your application, but there are many ways to launch a Java process, and this class should in no way be viewed as definitive. The `CommandLineJobRunner` performs four tasks:

- Load the appropriate `ApplicationContext`
- Parse command line arguments into `JobParameters`
- Locate the appropriate job based on arguments
- Use the `JobLauncher` provided in the application context to launch the job.

All of these tasks are accomplished using only the arguments passed in. The following are required arguments:

Table 4.1. `CommandLineJobRunner` arguments

jobPath	The location of the XML file that will be used to create an <code>ApplicationContext</code> . This file should contain everything needed to run the complete <code>Job</code>
jobName	The name of the job to be run.

These arguments must be passed in with the path first and the name second. All arguments after these are considered to be `JobParameters` and must be in the format of 'name=value':

```
bash$ java CommandLineJobRunner endOfDayJob.xml endOfDay schedule.date(date)=2007/05/05
```

In most cases you would want to use a manifest to declare your main class in a jar, but for simplicity, the class was used directly. This example is using the same 'EndOfDay' example from the [domain section](#). The first argument is 'endOfDayJob.xml', which is the Spring `ApplicationContext` containing the `Job`. The second argument, 'endOfDay' represents the job name. The final argument, 'schedule.date(date)=2007/05/05' will be converted into `JobParameters`. An example of the XML configuration is below:

```
<job id="endOfDay">
  <step id="step1" parent="simpleStep" />
</job>

<!-- Launcher details removed for clarity -->
<beans:bean id="jobLauncher"
  class="org.springframework.batch.core.launch.support.SimpleJobLauncher" />
```

This example is overly simplistic, since there are many more requirements to run a batch job in Spring Batch in general, but it serves to show the two main requirements of the `CommandLineJobRunner`: `Job` and `JobLauncher`

ExitCodes

When launching a batch job from the command-line, an enterprise scheduler is often used. Most schedulers are fairly dumb and work only at the process level. This means that they only know about some operating system process such as a shell script that they're invoking. In this scenario, the only way to communicate back to the scheduler about the success or failure of a job is through return codes. A return code is a number that is returned to a scheduler by the process that indicates the result of the run. In the simplest case: 0 is success and 1 is failure. However, there may be more complex scenarios: If job A returns 4 kick off job B, and if it returns 5 kick off job C. This type of behavior is configured at the scheduler level, but it is important that a processing framework such as Spring Batch provide a way to return a numeric representation of the 'Exit Code' for a particular batch job. In Spring Batch this is encapsulated within an `ExitStatus`, which is covered in more detail in Chapter 5. For the purposes of discussing exit codes, the only important thing to know is that an `ExitStatus` has an exit code property that is set by the framework (or the developer) and is returned as part of the `JobExecution` returned from the `JobLauncher`. The `CommandLineJobRunner` converts this string value to a number using the `ExitCodeMapper` interface:

```
public interface ExitCodeMapper {

    public int intValue(String exitCode);

}
```

The essential contract of an `ExitCodeMapper` is that, given a string exit code, a number representation will be returned. The default implementation used by the job runner is the `SimpleJvmExitCodeMapper` that returns 0 for completion, 1 for generic errors, and 2 for any job runner errors such as not being able to find a `Job` in the provided context. If anything more complex than the 3 values above is needed, then a custom implementation of the `ExitCodeMapper` interface must be supplied. Because the `CommandLineJobRunner` is the class that creates an `ApplicationContext`, and thus cannot be 'wired together', any values that need to be overwritten must be autowired. This means that if an implementation of `ExitCodeMapper` is found within the `BeanFactory`, it will be injected into the runner after the context is created. All that needs to be done to provide your own `ExitCodeMapper` is to declare the implementation as a root level bean and ensure that it is part of the `ApplicationContext` that is loaded by the runner.

Running Jobs from within a Web Container

Historically, offline processing such as batch jobs have been launched from the command-line, as described above. However, there are many cases where launching from an `HttpRequest` is a better option. Many such use cases include reporting, ad-hoc job running, and web application support. Because a batch job by definition is long running, the most important concern is ensuring to launch the job asynchronously:

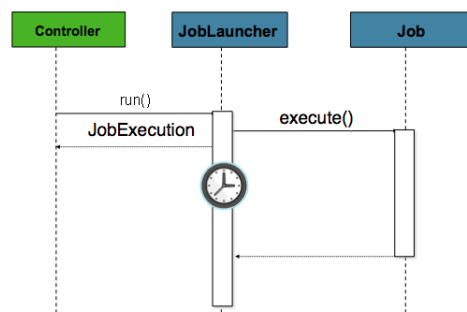

The controller in this case is a Spring MVC controller. More information on Spring MVC can be found here: <http://docs.spring.io/spring/docs/3.2.x/spring-framework-reference/html/mvc.html>. The controller launches a `Job` using a `JobLauncher` that has been configured to launch *asynchronously*, which immediately returns a `JobExecution`. The `Job` will likely still be running, however, this nonblocking behaviour allows the controller to return immediately, which is required when handling an `HttpRequest`. An example is below:

```
@Controller
public class JobLauncherController {

    @Autowired
    JobLauncher jobLauncher;

    @Autowired
    Job job;

    @RequestMapping("/jobLauncher.html")
    public void handle() throws Exception{
        jobLauncher.run(job, new JobParameters());
    }
}
```

4.6 Advanced Meta-Data Usage

So far, both the `JobLauncher` and `JobRepository` interfaces have been discussed. Together, they represent simple launching of a job, and basic CRUD operations of batch domain objects:

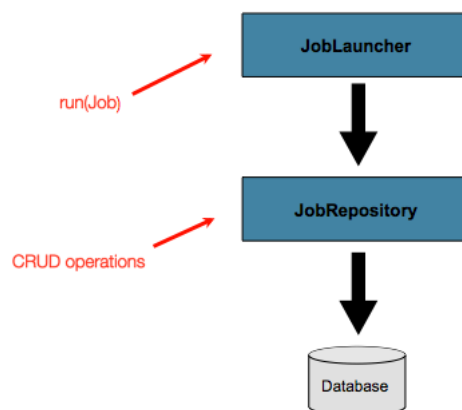

A `JobLauncher` uses the `JobRepository` to create new `JobExecution` objects and run them. `Job` and `Step` implementations later use the same `JobRepository` for basic updates of the same executions during the running of a `Job`. The basic operations suffice for simple scenarios, but in a large batch environment with hundreds of batch jobs and complex scheduling requirements, more advanced access of the meta data is required:

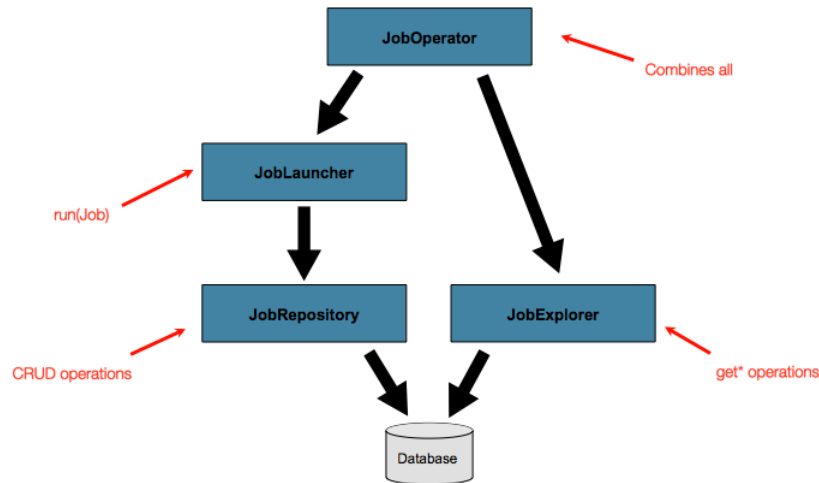

The `JobExplorer` and `JobOperator` interfaces, which will be discussed below, add additional functionality for querying and controlling the meta data.

Querying the Repository

The most basic need before any advanced features is the ability to query the repository for existing executions. This functionality is provided by the `JobExplorer` interface:

```

public interface JobExplorer {

    List<JobInstance> getJobInstances(String jobName, int start, int count);

    JobExecution getJobExecution(Long executionId);

    StepExecution getStepExecution(Long jobExecutionId, Long stepExecutionId);

    JobInstance getJobInstance(Long instanceId);

    List<JobExecution> getJobExecutions(JobInstance jobInstance);

    Set<JobExecution> findRunningJobExecutions(String jobName);
}
  
```

As is evident from the method signatures above, `JobExplorer` is a read-only version of the `JobRepository`, and like the `JobRepository`, it can be easily configured via a factory bean:

```

<bean id="jobExplorer" class="org.spr...JobExplorerFactoryBean"
      p:dataSource-ref="dataSource" />
  
```

[Earlier in this chapter](#), it was mentioned that the table prefix of the `JobRepository` can be modified to allow for different versions or schemas. Because the `JobExplorer` is working with the same tables, it too needs the ability to set a prefix:

```

<bean id="jobExplorer" class="org.spr...JobExplorerFactoryBean"
      p:dataSource-ref="dataSource" p:tablePrefix="BATCH_" />
  
```

JobRegistry

A `JobRegistry` (and its parent interface `JobLocator`) is not mandatory, but it can be useful if you want to keep track of which jobs are available in the context. It is also useful for collecting jobs centrally in an application context when they have been created elsewhere (e.g. in child contexts). Custom `JobRegistry`

implementations can also be used to manipulate the names and other properties of the jobs that are registered. There is only one implementation provided by the framework and this is based on a simple map from job name to job instance. It is configured simply like this:

```
<bean id="jobRegistry" class="org.spr...MapJobRegistry" />
```

There are two ways to populate a `JobRegistry` automatically: using a bean post processor and using a registrar lifecycle component. These two mechanisms are described in the following sections.

JobRegistryBeanPostProcessor

This is a bean post-processor that can register all jobs as they are created:

```
<bean id="jobRegistryBeanPostProcessor" class="org.spr...JobRegistryBeanPostProcessor">
  <property name="jobRegistry" ref="jobRegistry"/>
</bean>
```

Although it is not strictly necessary the post-processor in the example has been given an id so that it can be included in child contexts (e.g. as a parent bean definition) and cause all jobs created there to also be registered automatically.

AutomaticJobRegistrar

This is a lifecycle component that creates child contexts and registers jobs from those contexts as they are created. One advantage of doing this is that, while the job names in the child contexts still have to be globally unique in the registry, their dependencies can have "natural" names. So for example, you can create a set of XML configuration files each having only one `Job`, but all having different definitions of an `ItemReader` with the same bean name, e.g. "reader". If all those files were imported into the same context, the reader definitions would clash and override one another, but with the automatic registrar this is avoided. This makes it easier to integrate jobs contributed from separate modules of an application.

```
<bean class="org.spr...AutomaticJobRegistrar">
  <property name="applicationContextFactories">
    <bean class="org.spr...ClasspathXmlApplicationContextFactoryBean">
      <property name="resources" value="classpath*:/config/job*.xml" />
    </bean>
  </property>
  <property name="jobLoader">
    <bean class="org.spr...DefaultJobLoader">
      <property name="jobRegistry" ref="jobRegistry" />
    </bean>
  </property>
</bean>
```

The registrar has two mandatory properties, one is an array of `ApplicationContextFactory` (here created from a convenient factory bean), and the other is a `JobLoader`. The `JobLoader` is responsible for managing the lifecycle of the child contexts and registering jobs in the `JobRegistry`.

The `ApplicationContextFactory` is responsible for creating the child context and the most common usage would be as above using a `ClasspathXmlApplicationContextFactory`. One of the features of this factory is that by default it copies some of the configuration down from the parent context to the child. So for instance you don't have to re-define the `PropertyPlaceholderConfigurer` or AOP configuration in the child, if it should be the same as the parent.

The `AutomaticJobRegistrar` can be used in conjunction with a `JobRegistryBeanPostProcessor` if desired (as long as the `DefaultJobLoader` is used as well).

For instance this might be desirable if there are jobs defined in the main parent context as well as in the child locations.

JobOperator

As previously discussed, the `JobRepository` provides CRUD operations on the meta-data, and the `JobExplorer` provides read-only operations on the meta-data. However, those operations are most useful when used together to perform common monitoring tasks such as stopping, restarting, or summarizing a Job, as is commonly done by batch operators. Spring Batch provides for these types of operations via the `JobOperator` interface:

```
public interface JobOperator {

    List<Long> getExecutions(long instanceId) throws NoSuchJobInstanceException;

    List<Long> getJobInstances(String jobName, int start, int count)
        throws NoSuchJobException;

    Set<Long> getRunningExecutions(String jobName) throws NoSuchJobException;

    String getParameters(long executionId) throws NoSuchJobExecutionException;

    Long start(String jobName, String parameters)
        throws NoSuchJobException, JobInstanceAlreadyExistsException;

    Long restart(long executionId)
        throws JobInstanceAlreadyCompleteException, NoSuchJobExecutionException,
            NoSuchJobException, JobRestartException;

    Long startNextInstance(String jobName)
        throws NoSuchJobException, JobParametersNotFoundException, JobRestartException,
            JobExecutionAlreadyRunningException, JobInstanceAlreadyCompleteException;

    boolean stop(long executionId)
        throws NoSuchJobExecutionException, JobExecutionNotRunningException;

    String getSummary(long executionId) throws NoSuchJobExecutionException;

    Map<Long, String> getStepExecutionSummaries(long executionId)
        throws NoSuchJobExecutionException;

    Set<String> getJobNames();

}
```

The above operations represent methods from many different interfaces, such as `JobLauncher`, `JobRepository`, `JobExplorer`, and `JobRegistry`. For this reason, the provided implementation of `JobOperator`, `SimpleJobOperator`, has many dependencies:

```
<bean id="jobOperator" class="org.spr...SimpleJobOperator">
  <property name="jobExplorer">
    <bean class="org.spr...JobExplorerFactoryBean">
      <property name="dataSource" ref="dataSource" />
    </bean>
  </property>
  <property name="jobRepository" ref="jobRepository" />
  <property name="jobRegistry" ref="jobRegistry" />
  <property name="jobLauncher" ref="jobLauncher" />
</bean>
```

Note

If you set the table prefix on the job repository, don't forget to set it on the job explorer as well.

JobParametersIncrementer

Most of the methods on `JobOperator` are self-explanatory, and more detailed explanations can be found on the [javadoc of the interface](#). However, the `startNextInstance` method is worth noting. This method will always start a new instance of a `Job`. This can be extremely useful if there are serious issues in a `JobExecution` and the `Job` needs to be started over again from the beginning. Unlike `JobLauncher` though, which requires a new `JobParameters` object that will trigger a new `JobInstance` if the parameters are different from any previous set of parameters, the `startNextInstance` method will use the `JobParametersIncrementer` tied to the `Job` to force the `Job` to a new instance:

```
public interface JobParametersIncrementer {

    JobParameters getNext(JobParameters parameters);

}
```

The contract of `JobParametersIncrementer` is that, given a `JobParameters` object, it will return the 'next' `JobParameters` object by incrementing any necessary values it may contain. This strategy is useful because the framework has no way of knowing what changes to the `JobParameters` make it the 'next' instance. For example, if the only value in `JobParameters` is a date, and the next instance should be created, should that value be incremented by one day? Or one week (if the job is weekly for instance)? The same can be said for any numerical values that help to identify the `Job`, as shown below:

```
public class SampleIncrementer implements JobParametersIncrementer {

    public JobParameters getNext(JobParameters parameters) {
        if (parameters==null || parameters.isEmpty()) {
            return new JobParametersBuilder().addLong("run.id", 1L).toJobParameters();
        }
        long id = parameters.getLong("run.id",1L) + 1;
        return new JobParametersBuilder().addLong("run.id", id).toJobParameters();
    }

}
```

In this example, the value with a key of 'run.id' is used to discriminate between `JobInstances`. If the `JobParameters` passed in is null, it can be assumed that the `Job` has never been run before and thus its initial state can be returned. However, if not, the old value is obtained, incremented by one, and returned. An incrementer can be associated with `Job` via the 'incrementer' attribute in the namespace:

```
<job id="footballJob" incrementer="sampleIncrementer">
    ...
</job>
```

Stopping a Job

One of the most common use cases of `JobOperator` is gracefully stopping a `Job`:

```
Set<Long> executions = jobOperator.getRunningExecutions("sampleJob");
jobOperator.stop(executions.iterator().next());
```

The shutdown is not immediate, since there is no way to force immediate shutdown, especially if the execution is currently in developer code that the framework has no control over, such as a business service. However, as soon as control is returned back to the framework, it will set the status of the current `StepExecution` to `BatchStatus.STOPPED`, save it, then do the same for the `JobExecution` before finishing.

Aborting a Job

A job execution which is `FAILED` can be restarted (if the Job is restartable). A job execution whose status is `ABANDONED` will not be restarted by the framework. The `ABANDONED` status is also used in step executions to mark them as skippable in a restarted job execution: if a job is executing and encounters a step that has been marked `ABANDONED` in the previous failed job execution, it will move on to the next step (as determined by the job flow definition and the step execution exit status).

If the process died ("`kill -9`" or server failure) the job is, of course, not running, but the `JobRepository` has no way of knowing because no-one told it before the process died. You have to tell it manually that you know that the execution either failed or should be considered aborted (change its status to `FAILED` or `ABANDONED`) - it's a business decision and there is no way to automate it. Only change the status to `FAILED` if it is not restartable, or if you know the restart data is valid. There is a utility in Spring Batch Admin `JobService` to abort a job execution.

5. Configuring a Step

As discussed in Batch Domain Language, a `Step` is a domain object that encapsulates an independent, sequential phase of a batch job and contains all of the information necessary to define and control the actual batch processing. This is a necessarily vague description because the contents of any given `Step` are at the discretion of the developer writing a `Job`. A `Step` can be as simple or complex as the developer desires. A simple `Step` might load data from a file into the database, requiring little or no code. (depending upon the implementations used) A more complex `Step` may have complicated business rules that are applied as part of the processing.

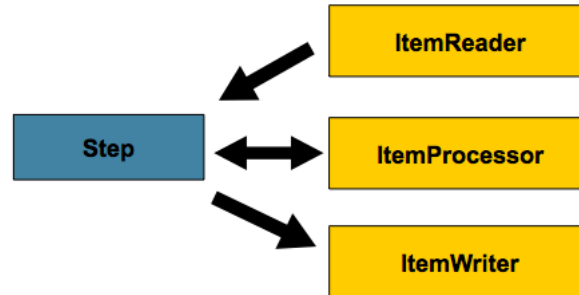

5.1 Chunk-Oriented Processing

Spring Batch uses a 'Chunk Oriented' processing style within its most common implementation. Chunk oriented processing refers to reading the data one at a time, and creating 'chunks' that will be written out, within a transaction boundary. One item is read in from an `ItemReader`, handed to an `ItemProcessor`, and aggregated. Once the number of items read equals the commit interval, the entire chunk is written out via the `ItemWriter`, and then the transaction is committed.

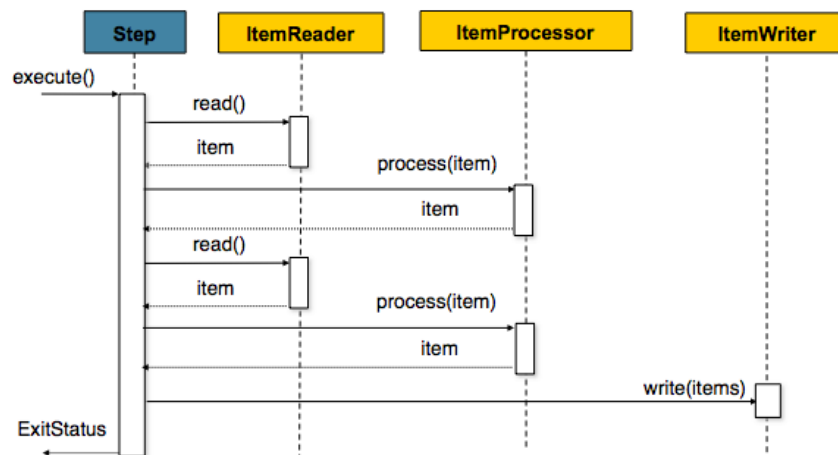

Below is a code representation of the same concepts shown above:

```

List items = new ArrayList();
for(int i = 0; i < commitInterval; i++){
    Object item = itemReader.read()
    Object processedItem = itemProcessor.process(item);
    items.add(processedItem);
}
itemWriter.write(items);
  
```

Configuring a Step

Despite the relatively short list of required dependencies for a `Step`, it is an extremely complex class that can potentially contain many collaborators. In order to ease configuration, the Spring Batch namespace can be used:

```
<job id="sampleJob" job-repository="jobRepository">
  <step id="step1">
    <tasklet transaction-manager="transactionManager">
      <chunk reader="itemReader" writer="itemWriter" commit-interval="10"/>
    </tasklet>
  </step>
</job>
```

The configuration above represents the only required dependencies to create a item-oriented step:

- `reader` - The `ItemReader` that provides items for processing.
- `writer` - The `ItemWriter` that processes the items provided by the `ItemReader`.
- `transaction-manager` - Spring's `PlatformTransactionManager` that will be used to begin and commit transactions during processing.
- `job-repository` - The `JobRepository` that will be used to periodically store the `StepExecution` and `ExecutionContext` during processing (just before committing). For an in-line `<step/>` (one defined within a `<job/>`) it is an attribute on the `<job/>` element; for a standalone step, it is defined as an attribute of the `<tasklet/>`.
- `commit-interval` - The number of items that will be processed before the transaction is committed.

It should be noted that, `job-repository` defaults to "jobRepository" and `transaction-manager` defaults to "transactionManger". Furthermore, the `ItemProcessor` is optional, not required, since the item could be directly passed from the reader to the writer.

Inheriting from a Parent Step

If a group of `Steps` share similar configurations, then it may be helpful to define a "parent" `Step` from which the concrete `Steps` may inherit properties. Similar to class inheritance in Java, the "child" `Step` will combine its elements and attributes with the parent's. The child will also override any of the parent's `Steps`.

In the following example, the `Step` "concreteStep1" will inherit from "parentStep". It will be instantiated with 'itemReader', 'itemProcessor', 'itemWriter', `startLimit=5`, and `allowStartIfComplete=true`. Additionally, the `commitInterval` will be '5' since it is overridden by the "concreteStep1":

```
<step id="parentStep">
  <tasklet allow-start-if-complete="true">
    <chunk reader="itemReader" writer="itemWriter" commit-interval="10"/>
  </tasklet>
</step>

<step id="concreteStep1" parent="parentStep">
  <tasklet start-limit="5">
    <chunk processor="itemProcessor" commit-interval="5"/>
  </tasklet>
</step>
```

The `id` attribute is still required on the step within the job element. This is for two reasons:

1. The id will be used as the step name when persisting the `StepExecution`. If the same standalone step is referenced in more than one step in the job, an error will occur.
2. When creating job flows, as described later in this chapter, the next attribute should be referring to the step in the flow, not the standalone step.

Abstract Step

Sometimes it may be necessary to define a parent `Step` that is not a complete `Step` configuration. If, for instance, the reader, writer, and tasklet attributes are left off of a `Step` configuration, then initialization will fail. If a parent must be defined without these properties, then the "abstract" attribute should be used. An "abstract" `Step` will not be instantiated; it is used only for extending.

In the following example, the `Step` "abstractParentStep" would not instantiate if it were not declared to be abstract. The `Step` "concreteStep2" will have 'itemReader', 'itemWriter', and `commitInterval=10`.

```
<step id="abstractParentStep" abstract="true">
  <tasklet>
    <chunk commit-interval="10"/>
  </tasklet>
</step>

<step id="concreteStep2" parent="abstractParentStep">
  <tasklet>
    <chunk reader="itemReader" writer="itemWriter"/>
  </tasklet>
</step>
```

Merging Lists

Some of the configurable elements on `Steps` are lists; the `<listeners/>` element, for instance. If both the parent and child `Steps` declare a `<listeners/>` element, then the child's list will override the parent's. In order to allow a child to add additional listeners to the list defined by the parent, every list element has a "merge" attribute. If the element specifies that `merge="true"`, then the child's list will be combined with the parent's instead of overriding it.

In the following example, the `Step` "concreteStep3" will be created will two listeners: `listenerOne` and `listenerTwo`:

```
<step id="listenersParentStep" abstract="true">
  <listeners>
    <listener ref="listenerOne"/>
  </listeners>
</step>

<step id="concreteStep3" parent="listenersParentStep">
  <tasklet>
    <chunk reader="itemReader" writer="itemWriter" commit-interval="5"/>
  </tasklet>
  <listeners merge="true">
    <listener ref="listenerTwo"/>
  </listeners>
</step>
```

The Commit Interval

As mentioned above, a step reads in and writes out items, periodically committing using the supplied `PlatformTransactionManager`. With a `commit-interval` of 1, it will commit after writing each individual item. This is less than ideal in many situations, since beginning and committing a transaction

is expensive. Ideally, it is preferable to process as many items as possible in each transaction, which is completely dependent upon the type of data being processed and the resources with which the step is interacting. For this reason, the number of items that are processed within a commit can be configured.

```
<job id="sampleJob">
  <step id="step1">
    <tasklet>
      <chunk reader="itemReader" writer="itemWriter" commit-interval="10"/>
    </tasklet>
  </step>
</job>
```

In the example above, 10 items will be processed within each transaction. At the beginning of processing a transaction is begun, and each time read is called on the `ItemReader`, a counter is incremented. When it reaches 10, the list of aggregated items is passed to the `ItemWriter`, and the transaction will be committed.

Configuring a Step for Restart

In Chapter 4, *Configuring and Running a Job*, restarting a `Job` was discussed. Restart has numerous impacts on steps, and as such may require some specific configuration.

Setting a StartLimit

There are many scenarios where you may want to control the number of times a `Step` may be started. For example, a particular `Step` might need to be configured so that it only runs once because it invalidates some resource that must be fixed manually before it can be run again. This is configurable on the step level, since different steps may have different requirements. A `Step` that may only be executed once can exist as part of the same `Job` as a `Step` that can be run infinitely. Below is an example start limit configuration:

```
<step id="step1">
  <tasklet start-limit="1">
    <chunk reader="itemReader" writer="itemWriter" commit-interval="10"/>
  </tasklet>
</step>
```

The simple step above can be run only once. Attempting to run it again will cause an exception to be thrown. It should be noted that the default value for the `start-limit` is `Integer.MAX_VALUE`.

Restarting a completed step

In the case of a restartable job, there may be one or more steps that should always be run, regardless of whether or not they were successful the first time. An example might be a validation step, or a `Step` that cleans up resources before processing. During normal processing of a restarted job, any step with a status of 'COMPLETED', meaning it has already been completed successfully, will be skipped. Setting `allow-start-if-complete` to "true" overrides this so that the step will always run:

```
<step id="step1">
  <tasklet allow-start-if-complete="true">
    <chunk reader="itemReader" writer="itemWriter" commit-interval="10"/>
  </tasklet>
</step>
```

Step Restart Configuration Example

```

<job id="footballJob" restartable="true">
  <step id="playerLoad" next="gameLoad">
    <tasklet>
      <chunk reader="playerFileItemReader" writer="playerWriter"
            commit-interval="10" />
    </tasklet>
  </step>
  <step id="gameLoad" next="playerSummarization">
    <tasklet allow-start-if-complete="true">
      <chunk reader="gameFileItemReader" writer="gameWriter"
            commit-interval="10"/>
    </tasklet>
  </step>
  <step id="playerSummarization">
    <tasklet start-limit="3">
      <chunk reader="playerSummarizationSource" writer="summaryWriter"
            commit-interval="10"/>
    </tasklet>
  </step>
</job>

```

The above example configuration is for a job that loads in information about football games and summarizes them. It contains three steps: `playerLoad`, `gameLoad`, and `playerSummarization`. The `playerLoad` Step loads player information from a flat file, while the `gameLoad` Step does the same for games. The final Step, `playerSummarization`, then summarizes the statistics for each player based upon the provided games. It is assumed that the file loaded by 'playerLoad' must be loaded only once, but that 'gameLoad' will load any games found within a particular directory, deleting them after they have been successfully loaded into the database. As a result, the `playerLoad` Step contains no additional configuration. It can be started almost limitlessly, and if complete will be skipped. The 'gameLoad' Step, however, needs to be run every time in case extra files have been dropped since it last executed. It has 'allow-start-if-complete' set to 'true' in order to always be started. (It is assumed that the database tables games are loaded into has a process indicator on it, to ensure new games can be properly found by the summarization step). The summarization Step, which is the most important in the Job, is configured to have a start limit of 3. This is useful because if the step continually fails, a new exit code will be returned to the operators that control job execution, and it won't be allowed to start again until manual intervention has taken place.

Note

This job is purely for example purposes and is not the same as the `footballJob` found in the samples project.

Run 1:

1. `playerLoad` is executed and completes successfully, adding 400 players to the 'PLAYERS' table.
2. `gameLoad` is executed and processes 11 files worth of game data, loading their contents into the 'GAMES' table.
3. `playerSummarization` begins processing and fails after 5 minutes.

Run 2:

1. `playerLoad` is not run, since it has already completed successfully, and `allow-start-if-complete` is 'false' (the default).

2. gameLoad is executed again and processes another 2 files, loading their contents into the 'GAMES' table as well (with a process indicator indicating they have yet to be processed)
3. playerSummarization begins processing of all remaining game data (filtering using the process indicator) and fails again after 30 minutes.

Run 3:

1. playerLoad is not run, since it has already completed successfully, and allow-start-if-complete is 'false' (the default).
2. gameLoad is executed again and processes another 2 files, loading their contents into the 'GAMES' table as well (with a process indicator indicating they have yet to be processed)
3. playerSummarization is not start, and the job is immediately killed, since this is the third execution of playerSummarization, and its limit is only 2. The limit must either be raised, or the Job must be executed as a new JobInstance.

Configuring Skip Logic

There are many scenarios where errors encountered while processing should not result in Step failure, but should be skipped instead. This is usually a decision that must be made by someone who understands the data itself and what meaning it has. Financial data, for example, may not be skippable because it results in money being transferred, which needs to be completely accurate. Loading a list of vendors, on the other hand, might allow for skips. If a vendor is not loaded because it was formatted incorrectly or was missing necessary information, then there probably won't be issues. Usually these bad records are logged as well, which will be covered later when discussing listeners.

```
<step id="step1">
  <tasklet>
    <chunk reader="flatFileItemReader" writer="itemWriter"
      commit-interval="10" skip-limit="10">
      <skippable-exception-classes>
        <include class="org.springframework.batch.item.file.FlatFileParseException"/>
      </skippable-exception-classes>
    </chunk>
  </tasklet>
</step>
```

In this example, a FlatFileItemReader is used, and if at any point a FlatFileParseException is thrown, it will be skipped and counted against the total skip limit of 10. Separate counts are made of skips on read, process and write inside the step execution, and the limit applies across all. Once the skip limit is reached, the next exception found will cause the step to fail.

One problem with the example above is that any other exception besides a FlatFileParseException will cause the Job to fail. In certain scenarios this may be the correct behavior. However, in other scenarios it may be easier to identify which exceptions should cause failure and skip everything else:

```

<step id="step1">
  <tasklet>
    <chunk reader="flatFileItemReader" writer="itemWriter"
      commit-interval="10" skip-limit="10">
      <skippable-exception-classes>
        <include class="java.lang.Exception"/>
        <exclude class="java.io.FileNotFoundException"/>
      </skippable-exception-classes>
    </chunk>
  </tasklet>
</step>

```

By 'including' `java.lang.Exception` as a skippable exception class, the configuration indicates that all Exceptions are skippable. However, by 'excluding' `java.io.FileNotFoundException`, the configuration refines the list of skippable exception classes to be all Exceptions *except* `FileNotFoundException`. Any excluded exception classes will be fatal if encountered (i.e. not skipped).

For any exception encountered, the skippability will be determined by the nearest superclass in the class hierarchy. Any unclassified exception will be treated as 'fatal'. The order of the `<include/>` and `<exclude/>` elements does not matter.

Configuring Retry Logic

In most cases you want an exception to cause either a skip or `Step` failure. However, not all exceptions are deterministic. If a `FlatFileParseException` is encountered while reading, it will always be thrown for that record; resetting the `ItemReader` will not help. However, for other exceptions, such as a `DeadlockLoserDataAccessException`, which indicates that the current process has attempted to update a record that another process holds a lock on, waiting and trying again might result in success. In this case, retry should be configured:

```

<step id="step1">
  <tasklet>
    <chunk reader="itemReader" writer="itemWriter"
      commit-interval="2" retry-limit="3">
      <retryable-exception-classes>
        <include class="org.springframework.dao.DeadlockLoserDataAccessException"/>
      </retryable-exception-classes>
    </chunk>
  </tasklet>
</step>

```

The `Step` allows a limit for the number of times an individual item can be retried, and a list of exceptions that are 'retryable'. More details on how retry works can be found in Chapter 9, *Retry*.

Controlling Rollback

By default, regardless of retry or skip, any exceptions thrown from the `ItemWriter` will cause the transaction controlled by the `Step` to rollback. If skip is configured as described above, exceptions thrown from the `ItemReader` will not cause a rollback. However, there are many scenarios in which exceptions thrown from the `ItemWriter` should not cause a rollback because no action has taken place to invalidate the transaction. For this reason, the `Step` can be configured with a list of exceptions that should not cause rollback.

```

<step id="step1">
  <tasklet>
    <chunk reader="itemReader" writer="itemWriter" commit-interval="2"/>
    <no-rollback-exception-classes>
      <include class="org.springframework.batch.item.validator.ValidationException"/>
    </no-rollback-exception-classes>
  </tasklet>
</step>

```

Transactional Readers

The basic contract of the `ItemReader` is that it is forward only. The step buffers reader input, so that in the case of a rollback the items don't need to be re-read from the reader. However, there are certain scenarios in which the reader is built on top of a transactional resource, such as a JMS queue. In this case, since the queue is tied to the transaction that is rolled back, the messages that have been pulled from the queue will be put back on. For this reason, the step can be configured to not buffer the items:

```

<step id="step1">
  <tasklet>
    <chunk reader="itemReader" writer="itemWriter" commit-interval="2"
      is-reader-transactional-queue="true"/>
  </tasklet>
</step>

```

Transaction Attributes

Transaction attributes can be used to control the isolation, propagation, and timeout settings. More information on setting transaction attributes can be found in the spring core documentation.

```

<step id="step1">
  <tasklet>
    <chunk reader="itemReader" writer="itemWriter" commit-interval="2"/>
    <transaction-attributes isolation="DEFAULT"
      propagation="REQUIRED"
      timeout="30"/>
  </tasklet>
</step>

```

Registering ItemStreams with the Step

The step has to take care of `ItemStream` callbacks at the necessary points in its lifecycle. (for more information on the `ItemStream` interface, please refer to Section 6.4, "ItemStream") This is vital if a step fails, and might need to be restarted, because the `ItemStream` interface is where the step gets the information it needs about persistent state between executions.

If the `ItemReader`, `ItemProcessor`, or `ItemWriter` itself implements the `ItemStream` interface, then these will be registered automatically. Any other streams need to be registered separately. This is often the case where there are indirect dependencies such as delegates being injected into the reader and writer. A stream can be registered on the `Step` through the 'streams' element, as illustrated below:

```

<step id="step1">
  <tasklet>
    <chunk reader="itemReader" writer="compositeWriter" commit-interval="2">
      <streams>
        <stream ref="fileItemWriter1"/>
        <stream ref="fileItemWriter2"/>
      </streams>
    </chunk>
  </tasklet>
</step>

<beans:bean id="compositeWriter"
  class="org.springframework.batch.item.support.CompositeItemWriter">
  <beans:property name="delegates">
    <beans:list>
      <beans:ref bean="fileItemWriter1" />
      <beans:ref bean="fileItemWriter2" />
    </beans:list>
  </beans:property>
</beans:bean>

```

In the example above, the `CompositeItemWriter` is not an `ItemStream`, but both of its delegates are. Therefore, both delegate writers must be explicitly registered as streams in order for the framework to handle them correctly. The `ItemReader` does not need to be explicitly registered as a stream because it is a direct property of the `Step`. The step will now be restartable and the state of the reader and writer will be correctly persisted in the event of a failure.

Intercepting Step Execution

Just as with the `Job`, there are many events during the execution of a `Step` where a user may need to perform some functionality. For example, in order to write out to a flat file that requires a footer, the `ItemWriter` needs to be notified when the `Step` has been completed, so that the footer can be written. This can be accomplished with one of many `Step` scoped listeners.

Any class that implements one of the extensions of `StepListener` (but not that interface itself since it is empty) can be applied to a step via the `listeners` element. The `listeners` element is valid inside a step, tasklet or chunk declaration. It is recommended that you declare the listeners at the level which its function applies, or if it is multi-featured (e.g. `StepExecutionListener` and `ItemReadListener`) then declare it at the most granular level that it applies (chunk in the example given).

```

<step id="step1">
  <tasklet>
    <chunk reader="reader" writer="writer" commit-interval="10"/>
    <listeners>
      <listener ref="chunkListener"/>
    </listeners>
  </tasklet>
</step>

```

An `ItemReader`, `ItemWriter` or `ItemProcessor` that itself implements one of the `StepListener` interfaces will be registered automatically with the `Step` if using the namespace `<step>` element, or one of the `*StepFactoryBean` factories. This only applies to components directly injected into the `Step`: if the listener is nested inside another component, it needs to be explicitly registered (as described above).

In addition to the `StepListener` interfaces, annotations are provided to address the same concerns. Plain old Java objects can have methods with these annotations that are then converted into the corresponding `StepListener` type. It is also common to annotate custom implementations of chunk components like `ItemReader` or `ItemWriter` or `Tasklet`. The annotations are analysed by the XML

parser for the `<listener/>` elements, so all you need to do is use the XML namespace to register the listeners with a step.

StepExecutionListener

`StepExecutionListener` represents the most generic listener for `Step` execution. It allows for notification before a `Step` is started and after it has ends, whether it ended normally or failed:

```
public interface StepExecutionListener extends StepListener {  
  
    void beforeStep(StepExecution stepExecution);  
  
    ExitStatus afterStep(StepExecution stepExecution);  
  
}
```

`ExitStatus` is the return type of `afterStep` in order to allow listeners the chance to modify the exit code that is returned upon completion of a `Step`.

The annotations corresponding to this interface are:

- `@BeforeStep`
- `@AfterStep`

ChunkListener

A chunk is defined as the items processed within the scope of a transaction. Committing a transaction, at each commit interval, commits a 'chunk'. A `ChunkListener` can be useful to perform logic before a chunk begins processing or after a chunk has completed successfully:

```
public interface ChunkListener extends StepListener {  
  
    void beforeChunk();  
    void afterChunk();  
  
}
```

The `beforeChunk` method is called after the transaction is started, but before `read` is called on the `ItemReader`. Conversely, `afterChunk` is called after the chunk has been committed (and not at all if there is a rollback).

The annotations corresponding to this interface are:

- `@BeforeChunk`
- `@AfterChunk`

A `ChunkListener` can be applied when there is no chunk declaration: it is the `TaskletStep` that is responsible for calling the `ChunkListener` so it applies to a non-item-oriented tasklet as well (called before and after the tasklet).

ItemReadListener

When discussing skip logic above, it was mentioned that it may be beneficial to log the skipped records, so that they can be deal with later. In the case of read errors, this can be done with an `ItemReaderListener`:

```
public interface ItemReadListener<T> extends StepListener {

    void beforeRead();
    void afterRead(T item);
    void onError(Exception ex);

}
```

The `beforeRead` method will be called before each call to `read` on the `ItemReader`. The `afterRead` method will be called after each successful call to `read`, and will be passed the item that was read. If there was an error while reading, the `onReadError` method will be called. The exception encountered will be provided so that it can be logged.

The annotations corresponding to this interface are:

- `@BeforeRead`
- `@AfterRead`
- `@OnReadError`

ItemProcessListener

Just as with the `ItemReadListener`, the processing of an item can be 'listened' to:

```
public interface ItemProcessListener<T, S> extends StepListener {

    void beforeProcess(T item);
    void afterProcess(T item, S result);
    void onError(T item, Exception e);

}
```

The `beforeProcess` method will be called before `process` on the `ItemProcessor`, and is handed the item that will be processed. The `afterProcess` method will be called after the item has been successfully processed. If there was an error while processing, the `onProcessError` method will be called. The exception encountered and the item that was attempted to be processed will be provided, so that they can be logged.

The annotations corresponding to this interface are:

- `@BeforeProcess`
- `@AfterProcess`
- `@OnProcessError`

ItemWriteListener

The writing of an item can be 'listened' to with the `ItemWriteListener`:

```
public interface ItemWriteListener<S> extends StepListener {

    void beforeWrite(List<? extends S> items);
    void afterWrite(List<? extends S> items);
    void onError(Exception exception, List<? extends S> items);

}
```

The `beforeWrite` method will be called before `write` on the `ItemWriter`, and is handed the item that will be written. The `afterWrite` method will be called after the item has been successfully written.

If there was an error while writing, the `onWriteError` method will be called. The exception encountered and the item that was attempted to be written will be provided, so that they can be logged.

The annotations corresponding to this interface are:

- `@BeforeWrite`
- `@AfterWrite`
- `@OnWriteError`

SkipListener

`ItemReadListener`, `ItemProcessListener`, and `ItemWriteListener` all provide mechanisms for being notified of errors, but none will inform you that a record has actually been skipped. `onWriteError`, for example, will be called even if an item is retried and successful. For this reason, there is a separate interface for tracking skipped items:

```
public interface SkipListener<T,S> extends StepListener {

    void onSkipInRead(Throwable t);
    void onSkipInProcess(T item, Throwable t);
    void onSkipInWrite(S item, Throwable t);

}
```

`onSkipInRead` will be called whenever an item is skipped while reading. It should be noted that rollbacks may cause the same item to be registered as skipped more than once. `onSkipInWrite` will be called when an item is skipped while writing. Because the item has been read successfully (and not skipped), it is also provided the item itself as an argument.

The annotations corresponding to this interface are:

- `@OnSkipInRead`
- `@OnSkipInWrite`
- `@OnSkipInProcess`

SkipListeners and Transactions

One of the most common use cases for a `SkipListener` is to log out a skipped item, so that another batch process or even human process can be used to evaluate and fix the issue leading to the skip. Because there are many cases in which the original transaction may be rolled back, Spring Batch makes two guarantees:

1. The appropriate skip method (depending on when the error happened) will only be called once per item.
2. The `SkipListener` will always be called just before the transaction is committed. This is to ensure that any transactional resources call by the listener are not rolled back by a failure within the `ItemWriter`.

5.2 TaskletStep

Chunk-oriented processing is not the only way to process in a `Step`. What if a `Step` must consist as a simple stored procedure call? You could implement the call as an `ItemReader` and return null after the

procedure finishes, but it is a bit unnatural since there would need to be a no-op `ItemWriter`. Spring Batch provides the `TaskletStep` for this scenario.

The `Tasklet` is a simple interface that has one method, `execute`, which will be called repeatedly by the `TaskletStep` until it either returns `RepeatStatus.FINISHED` or throws an exception to signal a failure. Each call to the `Tasklet` is wrapped in a transaction. `Tasklet` implementors might call a stored procedure, a script, or a simple SQL update statement. To create a `TaskletStep`, the `ref` attribute of the `<tasklet/>` element should reference a bean defining a `Tasklet` object; no `<chunk/>` element should be used within the `<tasklet/>`:

```
<step id="step1">
  <tasklet ref="myTasklet"/>
</step>
```

Note

`TaskletStep` will automatically register the tasklet as `StepListener` if it implements this interface

TaskletAdapter

As with other adapters for the `ItemReader` and `ItemWriter` interfaces, the `Tasklet` interface contains an implementation that allows for adapting itself to any pre-existing class: `TaskletAdapter`. An example where this may be useful is an existing DAO that is used to update a flag on a set of records. The `TaskletAdapter` can be used to call this class without having to write an adapter for the `Tasklet` interface:

```
<bean id="myTasklet" class="o.s.b.core.step.tasklet.MethodInvokingTaskletAdapter">
  <property name="targetObject">
    <bean class="org.mycompany.FooDao"/>
  </property>
  <property name="targetMethod" value="updateFoo" />
</bean>
```

Example Tasklet Implementation

Many batch jobs contain steps that must be done before the main processing begins in order to set up various resources or after processing has completed to cleanup those resources. In the case of a job that works heavily with files, it is often necessary to delete certain files locally after they have been uploaded successfully to another location. The example below taken from the Spring Batch samples project, is a `Tasklet` implementation with just such a responsibility:

```

public class FileDeletingTasklet implements Tasklet, InitializingBean {

    private Resource directory;

    public RepeatStatus execute(StepContribution contribution,
                               ChunkContext chunkContext) throws Exception {
        File dir = directory.getFile();
        Assert.state(dir.isDirectory());

        File[] files = dir.listFiles();
        for (int i = 0; i < files.length; i++) {
            boolean deleted = files[i].delete();
            if (!deleted) {
                throw new UnexpectedJobExecutionException("Could not delete file " +
                                                         files[i].getPath());
            }
        }
        return RepeatStatus.FINISHED;
    }

    public void setDirectoryResource(Resource directory) {
        this.directory = directory;
    }

    public void afterPropertiesSet() throws Exception {
        Assert.notNull(directory, "directory must be set");
    }
}

```

The above Tasklet implementation will delete all files within a given directory. It should be noted that the execute method will only be called once. All that is left is to reference the Tasklet from the Step:

```

<job id="taskletJob">
  <step id="deleteFilesInDir">
    <tasklet ref="fileDeletingTasklet"/>
  </step>
</job>

<beans:bean id="fileDeletingTasklet"
            class="org.springframework.batch.sample.tasklet.FileDeletingTasklet">
  <beans:property name="directoryResource">
    <beans:bean id="directory"
                class="org.springframework.core.io.FileSystemResource">
      <beans:constructor-arg value="target/test-outputs/test-dir" />
    </beans:bean>
  </beans:property>
</beans:bean>

```

5.3 Controlling Step Flow

With the ability to group steps together within an owning job comes the need to be able to control how the job 'flows' from one step to another. The failure of a Step doesn't necessarily mean that the Job should fail. Furthermore, there may be more than one type of 'success' which determines which Step should be executed next. Depending upon how a group of Steps is configured, certain steps may not even be processed at all.

Sequential Flow

The simplest flow scenario is a job where all of the steps execute sequentially:

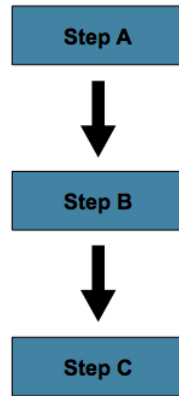

This can be achieved using the 'next' attribute of the step element:

```
<job id="job">
  <step id="stepA" parent="s1" next="stepB" />
  <step id="stepB" parent="s2" next="stepC"/>
  <step id="stepC" parent="s3" />
</job>
```

In the scenario above, 'step A' will execute first because it is the first `Step` listed. If 'step A' completes normally, then 'step B' will execute, and so on. However, if 'step A' fails, then the entire `Job` will fail and 'step B' will not execute.

Note

With the Spring Batch namespace, the first step listed in the configuration will *always* be the first step executed by the `Job`. The order of the other step elements does not matter, but the first step must always appear first in the xml.

Conditional Flow

In the example above, there are only two possibilities:

1. The `Step` is successful and the next `Step` should be executed.
2. The `Step` failed and thus the `Job` should fail.

In many cases, this may be sufficient. However, what about a scenario in which the failure of a `Step` should trigger a different `Step`, rather than causing failure?

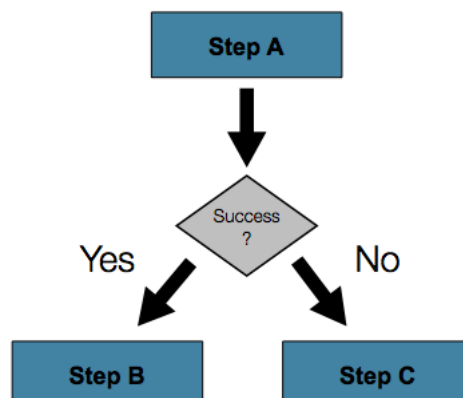

In order to handle more complex scenarios, the Spring Batch namespace allows transition elements to be defined within the step element. One such transition is the "next" element. Like the "next" attribute, the "next" element will tell the `Job` which `Step` to execute next. However, unlike the attribute, any number of "next" elements are allowed on a given `Step`, and there is no default behavior the case of failure. This means that if transition elements are used, then all of the behavior for the `Step`'s transitions must be defined explicitly. Note also that a single step cannot have both a "next" attribute and a transition element.

The next element specifies a pattern to match and the step to execute next:

```
<job id="job">
  <step id="stepA" parent="s1">
    <next on="*" to="stepB" />
    <next on="FAILED" to="stepC" />
  </step>
  <step id="stepB" parent="s2" next="stepC" />
  <step id="stepC" parent="s3" />
</job>
```

The "on" attribute of a transition element uses a simple pattern-matching scheme to match the `ExitStatus` that results from the execution of the `Step`. Only two special characters are allowed in the pattern:

- "*" will zero or more characters
- "?" will match exactly one character

For example, "c*t" will match "cat" and "count", while "c?t" will match "cat" but not "count".

While there is no limit to the number of transition elements on a `Step`, if the `Step`'s execution results in an `ExitStatus` that is not covered by an element, then the framework will throw an exception and the `Job` will fail. The framework will automatically order transitions from most specific to least specific. This means that even if the elements were swapped for "stepA" in the example above, an `ExitStatus` of "FAILED" would still go to "stepC".

Batch Status vs. Exit Status

When configuring a `Job` for conditional flow, it is important to understand the difference between `BatchStatus` and `ExitStatus`. `BatchStatus` is an enumeration that is a property of both `JobExecution` and `StepExecution` and is used by the framework to record the status of a `Job` or `Step`. It can be one of the following values: `COMPLETED`, `STARTING`, `STARTED`, `STOPPING`, `STOPPED`, `FAILED`, `ABANDONED` or `UNKNOWN`. Most of them are self explanatory: `COMPLETED` is the status set when a step or job has completed successfully, `FAILED` is set when it fails, and so on. The example above contains the following 'next' element:

```
<next on="FAILED" to="stepB" />
```

At first glance, it would appear that the 'on' attribute references the `BatchStatus` of the `Step` to which it belongs. However, it actually references the `ExitStatus` of the `Step`. As the name implies, `ExitStatus` represents the status of a `Step` after it finishes execution. More specifically, the 'next' element above references the exit code of the `ExitStatus`. To write it in English, it says: "go to stepB if the exit code is FAILED". By default, the exit code is always the same as the `BatchStatus` for the `Step`, which is why the entry above works. However, what if the exit code needs to be different? A good example comes from the skip sample job within the samples project:

```
<step id="step1" parent="s1">
  <end on="FAILED" />
  <next on="COMPLETED WITH SKIPS" to="errorPrint1" />
  <next on="*" to="step2" />
</step>
```

The above step has three possibilities:

1. The Step failed, in which case the job should fail.
2. The Step completed successfully.
3. The Step completed successfully, but with an exit code of 'COMPLETED WITH SKIPS'. In this case, a different step should be run to handle the errors.

The above configuration will work. However, something needs to change the exit code based on the condition of the execution having skipped records:

```
public class SkipCheckingListener extends StepExecutionListenerSupport {
    public ExitStatus afterStep(StepExecution stepExecution) {
        String exitCode = stepExecution.getExitStatus().getExitCode();
        if (!exitCode.equals(ExitStatus.FAILED.getExitCode()) &&
            stepExecution.getSkipCount() > 0) {
            return new ExitStatus("COMPLETED WITH SKIPS");
        }
        else {
            return null;
        }
    }
}
```

The above code is a `StepExecutionListener` that first checks to make sure the Step was successful, and next if the skip count on the `StepExecution` is higher than 0. If both conditions are met, a new `ExitStatus` with an exit code of "COMPLETED WITH SKIPS" is returned.

Configuring for Stop

After the discussion of [BatchStatus and ExitStatus](#), one might wonder how the `BatchStatus` and `ExitStatus` are determined for the `Job`. While these statuses are determined for the `Step` by the code that is executed, the statuses for the `Job` will be determined based on the configuration.

So far, all of the job configurations discussed have had at least one final `Step` with no transitions. For example, after the following step executes, the `Job` will end:

```
<step id="stepC" parent="s3"/>
```

If no transitions are defined for a `Step`, then the `Job`'s statuses will be defined as follows:

- If the `Step` ends with `ExitStatus FAILED`, then the `Job`'s `BatchStatus` and `ExitStatus` will both be `FAILED`.
- Otherwise, the `Job`'s `BatchStatus` and `ExitStatus` will both be `COMPLETED`.

While this method of terminating a batch job is sufficient for some batch jobs, such as a simple sequential step job, custom defined job-stopping scenarios may be required. For this purpose, Spring Batch provides three transition elements to stop a `Job` (in addition to the ["next" element](#) that we discussed previously). Each of these stopping elements will stop a `Job` with a particular `BatchStatus`. It is important to note that the stop transition elements will have no effect on either the `BatchStatus` or `ExitStatus` of any `Steps` in the `Job`: these elements will only affect the final statuses of the `Job`. For

example, it is possible for every step in a job to have a status of `FAILED` but the job to have a status of `COMPLETED`, or vice versa.

The 'End' Element

The 'end' element instructs a `Job` to stop with a `BatchStatus` of `COMPLETED`. A `Job` that has finished with status `COMPLETED` cannot be restarted (the framework will throw a `JobInstanceAlreadyCompleteException`). The 'end' element also allows for an optional 'exit-code' attribute that can be used to customize the `ExitStatus` of the `Job`. If no 'exit-code' attribute is given, then the `ExitStatus` will be `"COMPLETED"` by default, to match the `BatchStatus`.

In the following scenario, if `step2` fails, then the `Job` will stop with a `BatchStatus` of `COMPLETED` and an `ExitStatus` of `"COMPLETED"` and `step3` will not execute; otherwise, execution will move to `step3`. Note that if `step2` fails, the `Job` will not be restartable (because the status is `COMPLETED`).

```
<step id="step1" parent="s1" next="step2">
  <step id="step2" parent="s2">
    <end on="FAILED"/>
    <next on="*" to="step3"/>
  </step>
</step>
<step id="step3" parent="s3">
```

The 'Fail' Element

The 'fail' element instructs a `Job` to stop with a `BatchStatus` of `FAILED`. Unlike the 'end' element, the 'fail' element will not prevent the `Job` from being restarted. The 'fail' element also allows for an optional 'exit-code' attribute that can be used to customize the `ExitStatus` of the `Job`. If no 'exit-code' attribute is given, then the `ExitStatus` will be `"FAILED"` by default, to match the `BatchStatus`.

In the following scenario, if `step2` fails, then the `Job` will stop with a `BatchStatus` of `FAILED` and an `ExitStatus` of `"EARLY TERMINATION"` and `step3` will not execute; otherwise, execution will move to `step3`. Additionally, if `step2` fails, and the `Job` is restarted, then execution will begin again on `step2`.

```
<step id="step1" parent="s1" next="step2">
  <step id="step2" parent="s2">
    <fail on="FAILED" exit-code="EARLY TERMINATION"/>
    <next on="*" to="step3"/>
  </step>
</step>
<step id="step3" parent="s3">
```

The 'Stop' Element

The 'stop' element instructs a `Job` to stop with a `BatchStatus` of `STOPPED`. Stopping a `Job` can provide a temporary break in processing so that the operator can take some action before restarting the `Job`. The 'stop' element requires a 'restart' attribute that specifies the step where execution should pick up when the `Job` is restarted.

In the following scenario, if `step1` finishes with `COMPLETE`, then the job will then stop. Once it is restarted, execution will begin on `step2`.

```
<step id="step1" parent="s1">
  <stop on="COMPLETED" restart="step2"/>
</step>
<step id="step2" parent="s2"/>
```

Programmatic Flow Decisions

In some situations, more information than the `ExitStatus` may be required to decide which step to execute next. In this case, a `JobExecutionDecider` can be used to assist in the decision.

```
public class MyDecider implements JobExecutionDecider {
    public FlowExecutionStatus decide(JobExecution jobExecution, StepExecution stepExecution) {
        if (someCondition) {
            return "FAILED";
        }
        else {
            return "COMPLETED";
        }
    }
}
```

In the job configuration, a "decision" tag will specify the decider to use as well as all of the transitions.

```
<job id="job">
  <step id="step1" parent="s1" next="decision" />

  <decision id="decision" decider="decider">
    <next on="FAILED" to="step2" />
    <next on="COMPLETED" to="step3" />
  </decision>

  <step id="step2" parent="s2" next="step3"/>
  <step id="step3" parent="s3" />
</job>

<beans:bean id="decider" class="com.MyDecider"/>
```

Split Flows

Every scenario described so far has involved a `Job` that executes its `Steps` one at a time in a linear fashion. In addition to this typical style, the Spring Batch namespace also allows for a job to be configured with parallel flows using the 'split' element. As is seen below, the 'split' element contains one or more 'flow' elements, where entire separate flows can be defined. A 'split' element may also contain any of the previously discussed transition elements such as the 'next' attribute or the 'next', 'end', 'fail', or 'pause' elements.

```
<split id="split1" next="step4">
  <flow>
    <step id="step1" parent="s1" next="step2"/>
    <step id="step2" parent="s2"/>
  </flow>
  <flow>
    <step id="step3" parent="s3"/>
  </flow>
</split>
<step id="step4" parent="s4"/>
```

Externalizing Flow Definitions and Dependencies Between Jobs

Part of the flow in a job can be externalized as a separate bean definition, and then re-used. There are two ways to do this, and the first is to simply declare the flow as a reference to one defined elsewhere:

```

<job id="job">
  <flow id="job1.flow1" parent="flow1" next="step3"/>
  <step id="step3" parent="s3"/>
</job>

<flow id="flow1">
  <step id="step1" parent="s1" next="step2"/>
  <step id="step2" parent="s2"/>
</flow>

```

The effect of defining an external flow like this is simply to insert the steps from the external flow into the job as if they had been declared inline. In this way many jobs can refer to the same template flow and compose such templates into different logical flows. This is also a good way to separate the integration testing of the individual flows.

The other form of an externalized flow is to use a `JobStep`. A `JobStep` is similar to a `FlowStep`, but actually creates and launches a separate job execution for the steps in the flow specified. Here is an example:

```

<job id="jobStepJob" restartable="true">
  <step id="jobStepJob.step1">
    <job ref="job" job-launcher="jobLauncher"
      job-parameters-extractor="jobParametersExtractor"/>
  </step>
</job>

<job id="job" restartable="true">...</job>

<bean id="jobParametersExtractor" class="org.spr...DefaultJobParametersExtractor">
  <property name="keys" value="input.file"/>
</bean>

```

The job parameters extractor is a strategy that determines how a the `ExecutionContext` for the `Step` is converted into `JobParameters` for the `Job` that is executed. The `JobStep` is useful when you want to have some more granular options for monitoring and reporting on jobs and steps. Using `JobStep` is also often a good answer to the question: "How do I create dependencies between jobs?". It is a good way to break up a large system into smaller modules and control the flow of jobs.

5.4 Late Binding of Job and Step Attributes

Both the XML and Flat File examples above use the Spring `Resource` abstraction to obtain a file. This works because `Resource` has a `getFile` method, which returns a `java.io.File`. Both XML and Flat File resources can be configured using standard Spring constructs:

```

<bean id="flatFileItemReader"
  class="org.springframework.batch.item.file.FlatFileItemReader">
  <property name="resource"
    value="file://outputs/20070122.testStream.CustomerReportStep.TEMP.txt" />
</bean>

```

The above `Resource` will load the file from the file system location specified. Note that absolute locations have to start with a double slash ("//"). In most spring applications, this solution is good enough because the names of these are known at compile time. However, in batch scenarios, the file name may need to be determined at runtime as a parameter to the job. This could be solved using '-D' parameters, i.e. a system property:

```

<bean id="flatFileItemReader"
  class="org.springframework.batch.item.file.FlatFileItemReader">
  <property name="resource" value="${input.file.name}" />
</bean>

```

All that would be required for this solution to work would be a system argument (-Dinput.file.name="file://file.txt"). (Note that although a `PropertyPlaceholderConfigurer` can be used here, it is not necessary if the system property is always set because the `ResourceEditor` in Spring already filters and does placeholder replacement on system properties.)

Often in a batch setting it is preferable to parameterize the file name in the [JobParameters](#) of the job, instead of through system properties, and access them that way. To accomplish this, Spring Batch allows for the late binding of various Job and Step attributes:

```
<bean id="flatFileItemReader" scope="step"
      class="org.springframework.batch.item.file.FlatFileItemReader">
  <property name="resource" value="#{jobParameters['input.file.name']}" />
</bean>
```

Both the `JobExecution` and `StepExecution` level `ExecutionContext` can be accessed in the same way:

```
<bean id="flatFileItemReader" scope="step"
      class="org.springframework.batch.item.file.FlatFileItemReader">
  <property name="resource" value="#{jobExecutionContext['input.file.name']}" />
</bean>
```

```
<bean id="flatFileItemReader" scope="step"
      class="org.springframework.batch.item.file.FlatFileItemReader">
  <property name="resource" value="#{stepExecutionContext['input.file.name']}" />
</bean>
```

Note

Any bean that uses late-binding must be declared with `scope="step"`. See for the section called "Step Scope" more information.

Note

If you are using Spring 3.0 (or above) the expressions in step-scoped beans are in the Spring Expression Language, a powerful general purpose language with many interesting features. To provide backward compatibility, if Spring Batch detects the presence of older versions of Spring it uses a native expression language that is less powerful, and has slightly different parsing rules. The main difference is that the map keys in the example above do not need to be quoted with Spring 2.5, but the quotes are mandatory in Spring 3.0.

Step Scope

All of the late binding examples from above have a scope of "step" declared on the bean definition:

```
<bean id="flatFileItemReader" scope="step"
      class="org.springframework.batch.item.file.FlatFileItemReader">
  <property name="resource" value="#{jobParameters[input.file.name]}" />
</bean>
```

Using a scope of `Step` is required in order to use late binding since the bean cannot actually be instantiated until the `Step` starts, which allows the attributes to be found. Because it is not part of the Spring container by default, the scope must be added explicitly, either by using the `batch` namespace:

```
<beans xmlns="http://www.springframework.org/schema/beans"
       xmlns:batch="http://www.springframework.org/schema/batch"
       xmlns:xsi="http://www.w3.org/2001/XMLSchema-instance"
       xsi:schemaLocation="...">
<batch:job .../>
...
</beans>
```

or by including a bean definition explicitly for the `StepScope` (but not both):

```
<bean class="org.springframework.batch.core.scope.StepScope" />
```

Job Scope

Job scope, introduced in Spring Batch 3.0 is similar to Step scope in configuration but is a Scope for the Job context so there is only one instance of such a bean per executing job. Additionally, support is provided for late binding of references accessible from the JobContext using `#{..}` placeholders. Using this feature, bean properties can be pulled from the job or job execution context and the job parameters. E.g.

```
<bean id="..." class="..." scope="job">
  <property name="name" value="#{jobParameters[input]}" />
</bean>
```

```
<bean id="..." class="..." scope="job">
  <property name="name" value="#{jobExecutionContext['input.name']}.txt" />
</bean>
```

Because it is not part of the Spring container by default, the scope must be added explicitly, either by using the `batch` namespace:

```
<beans xmlns="http://www.springframework.org/schema/beans"
       xmlns:batch="http://www.springframework.org/schema/batch"
       xmlns:xsi="http://www.w3.org/2001/XMLSchema-instance"
       xsi:schemaLocation="...">

  <batch:job .../>
  ...
</beans>
```

Or by including a bean definition explicitly for the `JobScope` (but not both):

```
<bean class="org.springframework.batch.core.scope.JobScope" />
```

6. ItemReaders and ItemWriters

All batch processing can be described in its most simple form as reading in large amounts of data, performing some type of calculation or transformation, and writing the result out. Spring Batch provides three key interfaces to help perform bulk reading and writing: `ItemReader`, `ItemProcessor` and `ItemWriter`.

6.1 ItemReader

Although a simple concept, an `ItemReader` is the means for providing data from many different types of input. The most general examples include:

- Flat File- Flat File Item Readers read lines of data from a flat file that typically describe records with fields of data defined by fixed positions in the file or delimited by some special character (e.g. Comma).
- XML - XML ItemReaders process XML independently of technologies used for parsing, mapping and validating objects. Input data allows for the validation of an XML file against an XSD schema.
- Database - A database resource is accessed to return resultsets which can be mapped to objects for processing. The default SQL ItemReaders invoke a `RowMapper` to return objects, keep track of the current row if restart is required, store basic statistics, and provide some transaction enhancements that will be explained later.

There are many more possibilities, but we'll focus on the basic ones for this chapter. A complete list of all available `ItemReaders` can be found in Appendix A.

`ItemReader` is a basic interface for generic input operations:

```
public interface ItemReader<T> {  
  
    T read() throws Exception, UnexpectedInputException, ParseException;  
  
}
```

The `read` method defines the most essential contract of the `ItemReader`; calling it returns one `Item` or null if no more items are left. An item might represent a line in a file, a row in a database, or an element in an XML file. It is generally expected that these will be mapped to a usable domain object (i.e. Trade, Foo, etc) but there is no requirement in the contract to do so.

It is expected that implementations of the `ItemReader` interface will be forward only. However, if the underlying resource is transactional (such as a JMS queue) then calling `read` may return the same logical item on subsequent calls in a rollback scenario. It is also worth noting that a lack of items to process by an `ItemReader` will not cause an exception to be thrown. For example, a database `ItemReader` that is configured with a query that returns 0 results will simply return null on the first invocation of `read`.

6.2 ItemWriter

`ItemWriter` is similar in functionality to an `ItemReader`, but with inverse operations. Resources still need to be located, opened and closed but they differ in that an `ItemWriter` writes out, rather than reading in. In the case of databases or queues these may be inserts, updates, or sends. The format of the serialization of the output is specific to each batch job.

As with `ItemReader`, `ItemWriter` is a fairly generic interface:

```
public interface ItemWriter<T> {
    void write(List<? extends T> items) throws Exception;
}
```

As with `read` on `ItemReader`, `write` provides the basic contract of `ItemWriter`; it will attempt to write out the list of items passed in as long as it is open. Because it is generally expected that items will be 'batched' together into a chunk and then output, the interface accepts a list of items, rather than an item by itself. After writing out the list, any flushing that may be necessary can be performed before returning from the `write` method. For example, if writing to a Hibernate DAO, multiple calls to `write` can be made, one for each item. The writer can then call `close` on the hibernate `Session` before returning.

6.3 ItemProcessor

The `ItemReader` and `ItemWriter` interfaces are both very useful for their specific tasks, but what if you want to insert business logic before writing? One option for both reading and writing is to use the composite pattern: create an `ItemWriter` that contains another `ItemWriter`, or an `ItemReader` that contains another `ItemReader`. For example:

```
public class CompositeItemWriter<T> implements ItemWriter<T> {
    ItemWriter<T> itemWriter;

    public CompositeItemWriter(ItemWriter<T> itemWriter) {
        this.itemWriter = itemWriter;
    }

    public void write(List<? extends T> items) throws Exception {
        //Add business logic here
        itemWriter.write(item);
    }

    public void setDelegate(ItemWriter<T> itemWriter){
        this.itemWriter = itemWriter;
    }
}
```

The class above contains another `ItemWriter` to which it delegates after having provided some business logic. This pattern could easily be used for an `ItemReader` as well, perhaps to obtain more reference data based upon the input that was provided by the main `ItemReader`. It is also useful if you need to control the call to `write` yourself. However, if you only want to 'transform' the item passed in for writing before it is actually written, there isn't much need to call `write` yourself: you just want to modify the item. For this scenario, Spring Batch provides the `ItemProcessor` interface:

```
public interface ItemProcessor<I, O> {
    O process(I item) throws Exception;
}
```

An `ItemProcessor` is very simple; given one object, transform it and return another. The provided object may or may not be of the same type. The point is that business logic may be applied within process, and is completely up to the developer to create. An `ItemProcessor` can be wired directly into a step, For example, assuming an `ItemReader` provides a class of type `Foo`, and it needs to be converted to type `Bar` before being written out. An `ItemProcessor` can be written that performs the conversion:

```

public class Foo {}

public class Bar {
    public Bar(Foo foo) {}
}

public class FooProcessor implements ItemProcessor<Foo,Bar>{
    public Bar process(Foo foo) throws Exception {
        //Perform simple transformation, convert a Foo to a Bar
        return new Bar(foo);
    }
}

public class BarWriter implements ItemWriter<Bar>{
    public void write(List<? extends Bar> bars) throws Exception {
        //write bars
    }
}

```

In the very simple example above, there is a class `Foo`, a class `Bar`, and a class `FooProcessor` that adheres to the `ItemProcessor` interface. The transformation is simple, but any type of transformation could be done here. The `BarWriter` will be used to write out `Bar` objects, throwing an exception if any other type is provided. Similarly, the `FooProcessor` will throw an exception if anything but a `Foo` is provided. The `FooProcessor` can then be injected into a `Step`:

```

<job id="ioSampleJob">
  <step name="step1">
    <tasklet>
      <chunk reader="fooReader" processor="fooProcessor" writer="barWriter"
        commit-interval="2"/>
    </tasklet>
  </step>
</job>

```

Chaining ItemProcessors

Performing a single transformation is useful in many scenarios, but what if you want to 'chain' together multiple `ItemProcessors`? This can be accomplished using the composite pattern mentioned previously. To update the previous, single transformation, example, `Foo` will be transformed to `Bar`, which will be transformed to `FooBar` and written out:

```

public class Foo {}

public class Bar {
    public Bar(Foo foo) {}
}

public class Foobar{
    public Foobar(Bar bar) {}
}

public class FooProcessor implements ItemProcessor<Foo,Bar>{
    public Bar process(Foo foo) throws Exception {
        //Perform simple transformation, convert a Foo to a Bar
        return new Bar(foo);
    }
}

public class BarProcessor implements ItemProcessor<Bar,Foobar>{
    public Foobar process(Bar bar) throws Exception {
        return new Foobar(bar);
    }
}

public class FoobarWriter implements ItemWriter<Foobar>{
    public void write(List<? extends Foobar> items) throws Exception {
        //write items
    }
}

```

A `FooProcessor` and `BarProcessor` can be 'chained' together to give the resultant `Foobar`:

```

CompositeItemProcessor<Foo,Foobar> compositeProcessor =
    new CompositeItemProcessor<Foo,Foobar>();

List itemProcessors = new ArrayList();
itemProcessors.add(new FooTransformer());
itemProcessors.add(new BarTransformer());
compositeProcessor.setDelegates(itemProcessors);

```

Just as with the previous example, the composite processor can be configured into the `Step`:

```

<job id="ioSampleJob">
    <step name="step1">
        <tasklet>
            <chunk reader="fooReader" processor="compositeProcessor" writer="foobarWriter"
                commit-interval="2"/>
        </tasklet>
    </step>
</job>

<bean id="compositeItemProcessor"
    class="org.springframework.batch.item.support.CompositeItemProcessor">
    <property name="delegates">
        <list>
            <bean class="..FooProcessor" />
            <bean class="..BarProcessor" />
        </list>
    </property>
</bean>

```

Filtering Records

One typical use for an item processor is to filter out records before they are passed to the `ItemWriter`. Filtering is an action distinct from skipping; skipping indicates that a record is invalid whereas filtering simply indicates that a record should not be written.

For example, consider a batch job that reads a file containing three different types of records: records to insert, records to update, and records to delete. If record deletion is not supported by the system, then we would not want to send any "delete" records to the `ItemWriter`. But, since these records are not actually bad records, we would want to filter them out, rather than skip. As a result, the `ItemWriter` would receive only "insert" and "update" records.

To filter a record, one simply returns "null" from the `ItemProcessor`. The framework will detect that the result is "null" and avoid adding that item to the list of records delivered to the `ItemWriter`. As usual, an exception thrown from the `ItemProcessor` will result in a skip.

Fault Tolerance

When a chunk is rolled back, items that have been cached during reading may be reprocessed. If a step is configured to be fault tolerant (uses skip or retry processing typically), any `ItemProcessor` used should be implemented in a way that is idempotent. Typically that would consist of performing no changes on the input item for the `ItemProcessor` and only updating the instance that is the result.

6.4 ItemStream

Both `ItemReaders` and `ItemWriters` serve their individual purposes well, but there is a common concern among both of them that necessitates another interface. In general, as part of the scope of a batch job, readers and writers need to be opened, closed, and require a mechanism for persisting state:

```
public interface ItemStream {  
  
    void open(ExecutionContext executionContext) throws ItemStreamException;  
  
    void update(ExecutionContext executionContext) throws ItemStreamException;  
  
    void close() throws ItemStreamException;  
}
```

Before describing each method, we should mention the `ExecutionContext`. Clients of an `ItemReader` that also implement `ItemStream` should call `open` before any calls to `read` in order to open any resources such as files or to obtain connections. A similar restriction applies to an `ItemWriter` that implements `ItemStream`. As mentioned in Chapter 2, if expected data is found in the `ExecutionContext`, it may be used to start the `ItemReader` or `ItemWriter` at a location other than its initial state. Conversely, `close` will be called to ensure that any resources allocated during `open` will be released safely. `update` is called primarily to ensure that any state currently being held is loaded into the provided `ExecutionContext`. This method will be called before committing, to ensure that the current state is persisted in the database before commit.

In the special case where the client of an `ItemStream` is a `Step` (from the Spring Batch Core), an `ExecutionContext` is created for each `StepExecution` to allow users to store the state of a particular execution, with the expectation that it will be returned if the same `JobInstance` is started again. For those familiar with Quartz, the semantics are very similar to a Quartz `JobDataMap`.

6.5 The Delegate Pattern and Registering with the Step

Note that the `CompositeItemWriter` is an example of the delegation pattern, which is common in Spring Batch. The delegates themselves might implement callback interfaces `StepListener`. If they do, and they are being used in conjunction with Spring Batch Core as part of a `Step` in a `Job`, then they almost certainly need to be registered manually with the `Step`. A reader, writer, or processor

that is directly wired into the Step will be registered automatically if it implements `ItemStream` or a `StepListener` interface. But because the delegates are not known to the `Step`, they need to be injected as listeners or streams (or both if appropriate):

```
<job id="ioSampleJob">
  <step name="step1">
    <tasklet>
      <chunk reader="fooReader" processor="fooProcessor" writer="compositeItemWriter"
        commit-interval="2">
        <streams>
          <stream ref="barWriter" />
        </streams>
      </chunk>
    </tasklet>
  </step>
</job>

<bean id="compositeItemWriter" class="..CustomCompositeItemWriter">
  <property name="delegate" ref="barWriter" />
</bean>

<bean id="barWriter" class="..BarWriter" />
```

6.6 Flat Files

One of the most common mechanisms for interchanging bulk data has always been the flat file. Unlike XML, which has an agreed upon standard for defining how it is structured (XSD), anyone reading a flat file must understand ahead of time exactly how the file is structured. In general, all flat files fall into two types: Delimited and Fixed Length. Delimited files are those in which fields are separated by a delimiter, such as a comma. Fixed Length files have fields that are a set length.

The FieldSet

When working with flat files in Spring Batch, regardless of whether it is for input or output, one of the most important classes is the `FieldSet`. Many architectures and libraries contain abstractions for helping you read in from a file, but they usually return a `String` or an array of `Strings`. This really only gets you halfway there. A `FieldSet` is Spring Batch's abstraction for enabling the binding of fields from a file resource. It allows developers to work with file input in much the same way as they would work with database input. A `FieldSet` is conceptually very similar to a `Jdbc ResultSet`. `FieldSets` only require one argument, a `String` array of tokens. Optionally, you can also configure in the names of the fields so that the fields may be accessed either by index or name as patterned after `ResultSet`:

```
String[] tokens = new String[]{"foo", "1", "true"};
FieldSet fs = new DefaultFieldSet(tokens);
String name = fs.readString(0);
int value = fs.readInt(1);
boolean booleanValue = fs.readBoolean(2);
```

There are many more options on the `FieldSet` interface, such as `Date`, `long`, `BigDecimal`, etc. The biggest advantage of the `FieldSet` is that it provides consistent parsing of flat file input. Rather than each batch job parsing differently in potentially unexpected ways, it can be consistent, both when handling errors caused by a format exception, or when doing simple data conversions.

FlatFileItemReader

A flat file is any type of file that contains at most two-dimensional (tabular) data. Reading flat files in the Spring Batch framework is facilitated by the class `FlatFileItemReader`, which provides

basic functionality for reading and parsing flat files. The two most important required dependencies of `FlatFileItemReader` are `Resource` and `LineMapper`. The `LineMapper` interface will be explored more in the next sections. The resource property represents a Spring Core `Resource`. Documentation explaining how to create beans of this type can be found in [Spring Framework, Chapter 5.Resources](#). Therefore, this guide will not go into the details of creating `Resource` objects. However, a simple example of a file system resource can be found below:

```
Resource resource = new FileSystemResource("resources/trades.csv");
```

In complex batch environments the directory structures are often managed by the EAI infrastructure where drop zones for external interfaces are established for moving files from ftp locations to batch processing locations and vice versa. File moving utilities are beyond the scope of the spring batch architecture but it is not unusual for batch job streams to include file moving utilities as steps in the job stream. It is sufficient that the batch architecture only needs to know how to locate the files to be processed. Spring Batch begins the process of feeding the data into the pipe from this starting point. However, [Spring Integration](#) provides many of these types of services.

The other properties in `FlatFileItemReader` allow you to further specify how your data will be interpreted:

Table 6.1. *FlatFileItemReader* Properties

Property	Type	Description
comments	String[]	Specifies line prefixes that indicate comment rows
encoding	String	Specifies what text encoding to use - default is "ISO-8859-1"
lineMapper	LineMapper	Converts a <code>String</code> to an <code>Object</code> representing the item.
linesToSkip	int	Number of lines to ignore at the top of the file
recordSeparatorPolicy	RecordSeparatorPolicy	Used to determine where the line endings are and do things like continue over a line ending if inside a quoted string.
resource	Resource	The resource from which to read.
skippedLinesCallback	LineCallbackHandler	Interface which passes the raw line content of the lines in the file to be skipped. If <code>linesToSkip</code> is set to 2, then this interface will be called twice.
strict	boolean	In strict mode, the reader will throw an exception on <code>ExecutionContext</code> if the input resource does not exist.

LineMapper

As with `RowMapper`, which takes a low level construct such as `ResultSet` and returns an `Object`, flat file processing requires the same construct to convert a `String` line into an `Object`:

```
public interface LineMapper<T> {  
  
    T mapLine(String line, int lineNumber) throws Exception;  
  
}
```

The basic contract is that, given the current line and the line number with which it is associated, the mapper should return a resulting domain object. This is similar to `RowMapper` in that each line is associated with its line number, just as each row in a `ResultSet` is tied to its row number. This allows the line number to be tied to the resulting domain object for identity comparison or for more informative logging. However, unlike `RowMapper`, the `LineMapper` is given a raw line which, as discussed above, only gets you halfway there. The line must be tokenized into a `FieldSet`, which can then be mapped to an object, as described below.

LineTokenizer

An abstraction for turning a line of input into a line into a `FieldSet` is necessary because there can be many formats of flat file data that need to be converted to a `FieldSet`. In Spring Batch, this interface is the `LineTokenizer`:

```
public interface LineTokenizer {  
  
    FieldSet tokenize(String line);  
  
}
```

The contract of a `LineTokenizer` is such that, given a line of input (in theory the `String` could encompass more than one line), a `FieldSet` representing the line will be returned. This `FieldSet` can then be passed to a `FieldSetMapper`. Spring Batch contains the following `LineTokenizer` implementations:

- `DelimitedLineTokenizer` - Used for files where fields in a record are separated by a delimiter. The most common delimiter is a comma, but pipes or semicolons are often used as well.
- `FixedLengthTokenizer` - Used for files where fields in a record are each a 'fixed width'. The width of each field must be defined for each record type.
- `PatternMatchingCompositeLineTokenizer` - Determines which among a list of `LineTokenizers` should be used on a particular line by checking against a pattern.

FieldSetMapper

The `FieldSetMapper` interface defines a single method, `mapFieldSet`, which takes a `FieldSet` object and maps its contents to an object. This object may be a custom DTO, a domain object, or a simple array, depending on the needs of the job. The `FieldSetMapper` is used in conjunction with the `LineTokenizer` to translate a line of data from a resource into an object of the desired type:

```
public interface FieldSetMapper<T> {  
  
    T mapFieldSet(FieldSet fieldSet);  
  
}
```

The pattern used is the same as the `RowMapper` used by `JdbcTemplate`.

DefaultLineMapper

Now that the basic interfaces for reading in flat files have been defined, it becomes clear that three basic steps are required:

1. Read one line from the file.
2. Pass the string line into the `LineTokenizer#tokenize()` method, in order to retrieve a `FieldSet`.
3. Pass the `FieldSet` returned from tokenizing to a `FieldSetMapper`, returning the result from the `ItemReader#read()` method.

The two interfaces described above represent two separate tasks: converting a line into a `FieldSet`, and mapping a `FieldSet` to a domain object. Because the input of a `LineTokenizer` matches the input of the `LineMapper` (a line), and the output of a `FieldSetMapper` matches the output of the `LineMapper`, a default implementation that uses both a `LineTokenizer` and `FieldSetMapper` is provided. The `DefaultLineMapper` represents the behavior most users will need:

```
public class DefaultLineMapper<T> implements LineMapper<T>, InitializingBean {

    private LineTokenizer tokenizer;

    private FieldSetMapper<T> fieldSetMapper;

    public T mapLine(String line, int lineNumber) throws Exception {
        return fieldSetMapper.mapFieldSet(tokenizer.tokenize(line));
    }

    public void setLineTokenizer(LineTokenizer tokenizer) {
        this.tokenizer = tokenizer;
    }

    public void setFieldSetMapper(FieldSetMapper<T> fieldSetMapper) {
        this.fieldSetMapper = fieldSetMapper;
    }
}
```

The above functionality is provided in a default implementation, rather than being built into the reader itself (as was done in previous versions of the framework) in order to allow users greater flexibility in controlling the parsing process, especially if access to the raw line is needed.

Simple Delimited File Reading Example

The following example will be used to illustrate this using an actual domain scenario. This particular batch job reads in football players from the following file:

```
ID,lastName,firstName,position,birthYear,debutYear
"AbduKa00,Abdul-Jabbar,Karim,rb,1974,1996",
"AbduRa00,Abdullah,Rabih,rb,1975,1999",
"AberWa00,Abercrombie,Walter,rb,1959,1982",
"AbraDa00,Abramowicz,Danny,wr,1945,1967",
"AdamBo00,Adams,Bob,te,1946,1969",
"AdamCh00,Adams,Charlie,wr,1979,2003"
```

The contents of this file will be mapped to the following `Player` domain object:

```

public class Player implements Serializable {

    private String ID;
    private String lastName;
    private String firstName;
    private String position;
    private int birthYear;
    private int debutYear;

    public String toString() {
        return "PLAYER:ID=" + ID + ",Last Name=" + lastName +
            ",First Name=" + firstName + ",Position=" + position +
            ",Birth Year=" + birthYear + ",DebutYear=" +
            debutYear;
    }

    // setters and getters...
}

```

In order to map a `FieldSet` into a `Player` object, a `FieldSetMapper` that returns players needs to be defined:

```

protected static class PlayerFieldSetMapper implements FieldSetMapper<Player> {
    public Player mapFieldSet(FieldSet fieldSet) {
        Player player = new Player();

        player.setID(fieldSet.readString(0));
        player.setLastName(fieldSet.readString(1));
        player.setFirstName(fieldSet.readString(2));
        player.setPosition(fieldSet.readString(3));
        player.setBirthYear(fieldSet.readInt(4));
        player.setDebutYear(fieldSet.readInt(5));

        return player;
    }
}

```

The file can then be read by correctly constructing a `FlatFileItemReader` and calling `read`:

```

FlatFileItemReader<Player> itemReader = new FlatFileItemReader<Player>();
itemReader.setResource(new FileSystemResource("resources/players.csv"));
//DelimitedLineTokenizer defaults to comma as its delimiter
DefaultLineMapper<Player> lineMapper = new DefaultLineMapper<Player>();
lineMapper.setLineTokenizer(new DelimitedLineTokenizer());
lineMapper.setFieldSetMapper(new PlayerFieldSetMapper());
itemReader.setLineMapper(lineMapper);
itemReader.open(new ExecutionContext());
Player player = itemReader.read();

```

Each call to `read` will return a new `Player` object from each line in the file. When the end of the file is reached, null will be returned.

Mapping Fields by Name

There is one additional piece of functionality that is allowed by both `DelimitedLineTokenizer` and `FixedLengthTokenizer` that is similar in function to a `Jdbc ResultSet`. The names of the fields can be injected into either of these `LineTokenizer` implementations to increase the readability of the mapping function. First, the column names of all fields in the flat file are injected into the tokenizer:

```

tokenizer.setNames(new String[] {"ID", "lastName", "firstName", "position", "birthYear", "debutYear"});

```

A `FieldSetMapper` can use this information as follows:

```

public class PlayerMapper implements FieldSetMapper<Player> {
    public Player mapFieldSet(FieldSet fs) {

        if(fs == null){
            return null;
        }

        Player player = new Player();
        player.setID(fs.readString("ID"));
        player.setLastName(fs.readString("lastName"));
        player.setFirstName(fs.readString("firstName"));
        player.setPosition(fs.readString("position"));
        player.setDebutYear(fs.readInt("debutYear"));
        player.setBirthYear(fs.readInt("birthYear"));

        return player;
    }
}

```

Automapping FieldSets to Domain Objects

For many, having to write a specific `FieldSetMapper` is equally as cumbersome as writing a specific `RowMapper` for a `JdbcTemplate`. Spring Batch makes this easier by providing a `FieldSetMapper` that automatically maps fields by matching a field name with a setter on the object using the JavaBean specification. Again using the football example, the `BeanWrapperFieldSetMapper` configuration looks like the following:

```

<bean id="fieldSetMapper"
    class="org.springframework.batch.item.file.mapping.BeanWrapperFieldSetMapper">
    <property name="prototypeBeanName" value="player" />
</bean>

<bean id="player"
    class="org.springframework.batch.sample.domain.Player"
    scope="prototype" />

```

For each entry in the `FieldSet`, the mapper will look for a corresponding setter on a new instance of the `Player` object (for this reason, prototype scope is required) in the same way the Spring container will look for setters matching a property name. Each available field in the `FieldSet` will be mapped, and the resultant `Player` object will be returned, with no code required.

Fixed Length File Formats

So far only delimited files have been discussed in much detail, however, they represent only half of the file reading picture. Many organizations that use flat files use fixed length formats. An example fixed length file is below:

```

UK21341EAH4121131.11customer1
UK21341EAH4221232.11customer2
UK21341EAH4321333.11customer3
UK21341EAH4421434.11customer4
UK21341EAH4521535.11customer5

```

While this looks like one large field, it actually represent 4 distinct fields:

1. ISIN: Unique identifier for the item being order - 12 characters long.
2. Quantity: Number of this item being ordered - 3 characters long.
3. Price: Price of the item - 5 characters long.
4. Customer: Id of the customer ordering the item - 9 characters long.

When configuring the `FixedLengthLineTokenizer`, each of these lengths must be provided in the form of ranges:

```
<bean id="fixedLengthLineTokenizer"
      class="org.springframework.batch.io.file.transform.FixedLengthTokenizer">
  <property name="names" value="ISIN,Quantity,Price,Customer" />
  <property name="columns" value="1-12, 13-15, 16-20, 21-29" />
</bean>
```

Because the `FixedLengthLineTokenizer` uses the same `LineTokenizer` interface as discussed above, it will return the same `FieldSet` as if a delimiter had been used. This allows the same approaches to be used in handling its output, such as using the `BeanWrapperFieldSetMapper`.

Note

Supporting the above syntax for ranges requires that a specialized property editor, `RangeArrayPropertyEditor`, be configured in the `ApplicationContext`. However, this bean is automatically declared in an `ApplicationContext` where the batch namespace is used.

Multiple Record Types within a Single File

All of the file reading examples up to this point have all made a key assumption for simplicity's sake: all of the records in a file have the same format. However, this may not always be the case. It is very common that a file might have records with different formats that need to be tokenized differently and mapped to different objects. The following excerpt from a file illustrates this:

```
USER;Smith;Peter;;T;20014539;F
LINEA;1044391041ABC037.49G201XX1383.12H
LINEB;2134776319DEF422.99M005LI
```

In this file we have three types of records, "USER", "LINEA", and "LINEB". A "USER" line corresponds to a `User` object. "LINEA" and "LINEB" both correspond to `Line` objects, though a "LINEA" has more information than a "LINEB".

The `ItemReader` will read each line individually, but we must specify different `LineTokenizer` and `FieldSetMapper` objects so that the `ItemWriter` will receive the correct items. The `PatternMatchingCompositeLineMapper` makes this easy by allowing maps of patterns to `LineTokenizers` and patterns to `FieldSetMappers` to be configured:

```
<bean id="orderFileLineMapper"
      class="org.spr...PatternMatchingCompositeLineMapper">
  <property name="tokenizers">
    <map>
      <entry key="USER*" value-ref="userTokenizer" />
      <entry key="LINEA*" value-ref="lineATokenizer" />
      <entry key="LINEB*" value-ref="lineBTokenizer" />
    </map>
  </property>
  <property name="fieldSetMappers">
    <map>
      <entry key="USER*" value-ref="userFieldSetMapper" />
      <entry key="LINE*" value-ref="lineFieldSetMapper" />
    </map>
  </property>
</bean>
```

In this example, "LINEA" and "LINEB" have separate `LineTokenizers` but they both use the same `FieldSetMapper`.

The `PatternMatchingCompositeLineMapper` makes use of the `PatternMatcher`'s `match` method in order to select the correct delegate for each line. The `PatternMatcher` allows for two wildcard characters with special meaning: the question mark ("?") will match exactly one character, while the asterisk ("*") will match zero or more characters. Note that in the configuration above, all patterns end with an asterisk, making them effectively prefixes to lines. The `PatternMatcher` will always match the most specific pattern possible, regardless of the order in the configuration. So if "LINE*" and "LINEA*" were both listed as patterns, "LINEA" would match pattern "LINEA*", while "LINEB" would match pattern "LINE*". Additionally, a single asterisk ("*") can serve as a default by matching any line not matched by any other pattern.

```
<entry key="*" value-ref="defaultLineTokenizer" />
```

There is also a `PatternMatchingCompositeLineTokenizer` that can be used for tokenization alone.

It is also common for a flat file to contain records that each span multiple lines. To handle this situation, a more complex strategy is required. A demonstration of this common pattern can be found in Section 11.5, "Multi-Line Records".

Exception Handling in Flat Files

There are many scenarios when tokenizing a line may cause exceptions to be thrown. Many flat files are imperfect and contain records that aren't formatted correctly. Many users choose to skip these erroneous lines, logging out the issue, original line, and line number. These logs can later be inspected manually or by another batch job. For this reason, Spring Batch provides a hierarchy of exceptions for handling parse exceptions: `FlatFileParseException` and `FlatFileFormatException`. `FlatFileParseException` is thrown by the `FlatFileItemReader` when any errors are encountered while trying to read a file. `FlatFileFormatException` is thrown by implementations of the `LineTokenizer` interface, and indicates a more specific error encountered while tokenizing.

IncorrectTokenCountException

Both `DelimitedLineTokenizer` and `FixedLengthLineTokenizer` have the ability to specify column names that can be used for creating a `FieldSet`. However, if the number of column names doesn't match the number of columns found while tokenizing a line the `FieldSet` can't be created, and a `IncorrectTokenCountException` is thrown, which contains the number of tokens encountered, and the number expected:

```
tokenizer.setNames(new String[] {"A", "B", "C", "D"});

try {
    tokenizer.tokenize("a,b,c");
}
catch(IncorrectTokenCountException e){
    assertEquals(4, e.getExpectedCount());
    assertEquals(3, e.getActualCount());
}
```

Because the tokenizer was configured with 4 column names, but only 3 tokens were found in the file, an `IncorrectTokenCountException` was thrown.

IncorrectLineLengthException

Files formatted in a fixed length format have additional requirements when parsing because, unlike a delimited format, each column must strictly adhere to its predefined width. If the total line length doesn't add up to the widest value of this column, an exception is thrown:

```

tokenizer.setColumns(new Range[] { new Range(1, 5),
                                   new Range(6, 10),
                                   new Range(11, 15) });

try {
    tokenizer.tokenize("12345");
    fail("Expected IncorrectLineLengthException");
}
catch (IncorrectLineLengthException ex) {
    assertEquals(15, ex.getExpectedLength());
    assertEquals(5, ex.getActualLength());
}

```

The configured ranges for the tokenizer above are: 1-5, 6-10, and 11-15, thus the total length of the line expected is 15. However, in this case a line of length 5 was passed in, causing an `IncorrectLineLengthException` to be thrown. Throwing an exception here rather than only mapping the first column allows the processing of the line to fail earlier, and with more information than it would if it failed while trying to read in column 2 in a `FieldSetMapper`. However, there are scenarios where the length of the line isn't always constant. For this reason, validation of line length can be turned off via the 'strict' property:

```

tokenizer.setColumns(new Range[] { new Range(1, 5), new Range(6, 10) });
tokenizer.setStrict(false);
FieldSet tokens = tokenizer.tokenize("12345");
assertEquals("12345", tokens.readString(0));
assertEquals("", tokens.readString(1));

```

The above example is almost identical to the one before it, except that `tokenizer.setStrict(false)` was called. This setting tells the tokenizer to not enforce line lengths when tokenizing the line. A `FieldSet` is now correctly created and returned. However, it will only contain empty tokens for the remaining values.

FlatFileItemWriter

Writing out to flat files has the same problems and issues that reading in from a file must overcome. A step must be able to write out in either delimited or fixed length formats in a transactional manner.

LineAggregator

Just as the `LineTokenizer` interface is necessary to take an item and turn it into a `String`, file writing must have a way to aggregate multiple fields into a single string for writing to a file. In Spring Batch this is the `LineAggregator`:

```

public interface LineAggregator<T> {

    public String aggregate(T item);

}

```

The `LineAggregator` is the opposite of a `LineTokenizer`. `LineTokenizer` takes a `String` and returns a `FieldSet`, whereas `LineAggregator` takes an item and returns a `String`.

PassThroughLineAggregator

The most basic implementation of the `LineAggregator` interface is the `PassThroughLineAggregator`, which simply assumes that the object is already a string, or that its string representation is acceptable for writing:

```
public class PassThroughLineAggregator<T> implements LineAggregator<T> {

    public String aggregate(T item) {
        return item.toString();
    }
}
```

The above implementation is useful if direct control of creating the string is required, but the advantages of a `FlatFileItemWriter`, such as transaction and restart support, are necessary.

Simplified File Writing Example

Now that the `LineAggregator` interface and its most basic implementation, `PassThroughLineAggregator`, have been defined, the basic flow of writing can be explained:

1. The object to be written is passed to the `LineAggregator` in order to obtain a `String`.
2. The returned `String` is written to the configured file.

The following excerpt from the `FlatFileItemWriter` expresses this in code:

```
public void write(T item) throws Exception {
    write(lineAggregator.aggregate(item) + LINE_SEPARATOR);
}
```

A simple configuration would look like the following:

```
<bean id="itemWriter" class="org.spr...FlatFileItemWriter">
  <property name="resource" value="file:target/test-outputs/output.txt" />
  <property name="lineAggregator">
    <bean class="org.spr...PassThroughLineAggregator"/>
  </property>
</bean>
```

FieldExtractor

The above example may be useful for the most basic uses of a writing to a file. However, most users of the `FlatFileItemWriter` will have a domain object that needs to be written out, and thus must be converted into a line. In file reading, the following was required:

1. Read one line from the file.
2. Pass the string line into the `LineTokenizer#tokenize()` method, in order to retrieve a `FieldSet`
3. Pass the `FieldSet` returned from tokenizing to a `FieldSetMapper`, returning the result from the `ItemReader#read()` method

File writing has similar, but inverse steps:

1. Pass the item to be written to the writer
2. convert the fields on the item into an array
3. aggregate the resulting array into a line

Because there is no way for the framework to know which fields from the object need to be written out, a `FieldExtractor` must be written to accomplish the task of turning the item into an array:

```
public interface FieldExtractor<T> {
    Object[] extract(T item);
}
```

Implementations of the `FieldExtractor` interface should create an array from the fields of the provided object, which can then be written out with a delimiter between the elements, or as part of a field-width line.

PassThroughFieldExtractor

There are many cases where a collection, such as an array, `Collection`, or `FieldSet`, needs to be written out. "Extracting" an array from a one of these collection types is very straightforward: simply convert the collection to an array. Therefore, the `PassThroughFieldExtractor` should be used in this scenario. It should be noted, that if the object passed in is not a type of collection, then the `PassThroughFieldExtractor` will return an array containing solely the item to be extracted.

BeanWrapperFieldExtractor

As with the `BeanWrapperFieldSetMapper` described in the file reading section, it is often preferable to configure how to convert a domain object to an object array, rather than writing the conversion yourself. The `BeanWrapperFieldExtractor` provides just this type of functionality:

```
BeanWrapperFieldExtractor<Name> extractor = new BeanWrapperFieldExtractor<Name>();
extractor.setNames(new String[] { "first", "last", "born" });

String first = "Alan";
String last = "Turing";
int born = 1912;

Name n = new Name(first, last, born);
Object[] values = extractor.extract(n);

assertEquals(first, values[0]);
assertEquals(last, values[1]);
assertEquals(born, values[2]);
```

This extractor implementation has only one required property, the names of the fields to map. Just as the `BeanWrapperFieldSetMapper` needs field names to map fields on the `FieldSet` to setters on the provided object, the `BeanWrapperFieldExtractor` needs names to map to getters for creating an object array. It is worth noting that the order of the names determines the order of the fields within the array.

Delimited File Writing Example

The most basic flat file format is one in which all fields are separated by a delimiter. This can be accomplished using a `DelimitedLineAggregator`. The example below writes out a simple domain object that represents a credit to a customer account:

```
public class CustomerCredit {
    private int id;
    private String name;
    private BigDecimal credit;

    //getters and setters removed for clarity
}
```

Because a domain object is being used, an implementation of the `FieldExtractor` interface must be provided, along with the delimiter to use:

```

<bean id="itemWriter" class="org.springframework.batch.item.file.FlatFileItemWriter">
  <property name="resource" ref="outputResource" />
  <property name="lineAggregator">
    <bean class="org.springframework.batch.item.file.FlatFileItemWriter$DelimitedLineAggregator">
      <property name="delimiter" value="," />
      <property name="fieldExtractor">
        <bean class="org.springframework.batch.item.file.FlatFileItemWriter$BeanWrapperFieldExtractor">
          <property name="names" value="name,credit" />
        </bean>
      </property>
    </bean>
  </property>
</bean>

```

In this case, the `BeanWrapperFieldExtractor` described earlier in this chapter is used to turn the name and credit fields within `CustomerCredit` into an object array, which is then written out with commas between each field.

Fixed Width File Writing Example

Delimited is not the only type of flat file format. Many prefer to use a set width for each column to delineate between fields, which is usually referred to as 'fixed width'. Spring Batch supports this in file writing via the `FormatterLineAggregator`. Using the same `CustomerCredit` domain object described above, it can be configured as follows:

```

<bean id="itemWriter" class="org.springframework.batch.item.file.FlatFileItemWriter">
  <property name="resource" ref="outputResource" />
  <property name="lineAggregator">
    <bean class="org.springframework.batch.item.file.FlatFileItemWriter$FormatterLineAggregator">
      <property name="fieldExtractor">
        <bean class="org.springframework.batch.item.file.FlatFileItemWriter$BeanWrapperFieldExtractor">
          <property name="names" value="name,credit" />
        </bean>
      </property>
      <property name="format" value="%-9s%-2.0f" />
    </bean>
  </property>
</bean>

```

Most of the above example should look familiar. However, the value of the format property is new:

```

<property name="format" value="%-9s%-2.0f" />

```

The underlying implementation is built using the same `Formatter` added as part of Java 5. The Java `Formatter` is based on the `printf` functionality of the C programming language. Most details on how to configure a formatter can be found in the javadoc of [Formatter](#).

Handling File Creation

`FlatFileItemReader` has a very simple relationship with file resources. When the reader is initialized, it opens the file if it exists, and throws an exception if it does not. File writing isn't quite so simple. At first glance it seems like a similar straight forward contract should exist for `FlatFileItemWriter`: if the file already exists, throw an exception, and if it does not, create it and start writing. However, potentially restarting a `Job` can cause issues. In normal restart scenarios, the contract is reversed: if the file exists, start writing to it from the last known good position, and if it does not, throw an exception. However, what happens if the file name for this job is always the same? In this case, you would want to delete the file if it exists, unless it's a restart. Because of this possibility, the `FlatFileItemWriter` contains the property, `shouldDeleteIfExists`. Setting this property to true will cause an existing file with the same name to be deleted when the writer is opened.

6.7 XML Item Readers and Writers

Spring Batch provides transactional infrastructure for both reading XML records and mapping them to Java objects as well as writing Java objects as XML records.

Constraints on streaming XML

The StAX API is used for I/O as other standard XML parsing APIs do not fit batch processing requirements (DOM loads the whole input into memory at once and SAX controls the parsing process allowing the user only to provide callbacks).

Lets take a closer look how XML input and output works in Spring Batch. First, there are a few concepts that vary from file reading and writing but are common across Spring Batch XML processing. With XML processing, instead of lines of records (FieldSets) that need to be tokenized, it is assumed an XML resource is a collection of 'fragments' corresponding to individual records:

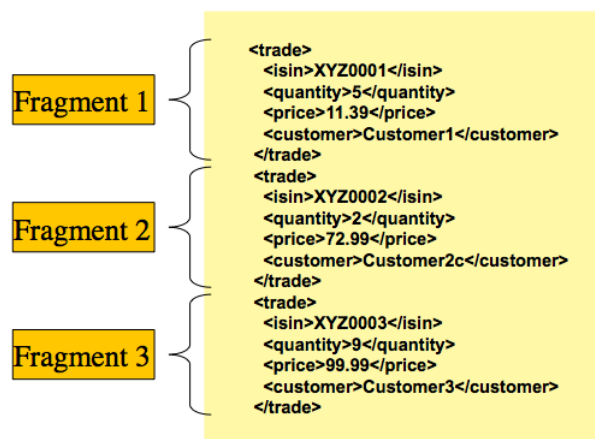

Figure 3.1: XML Input

The 'trade' tag is defined as the 'root element' in the scenario above. Everything between '<trade>' and '</trade>' is considered one 'fragment'. Spring Batch uses Object/XML Mapping (OXM) to bind fragments to objects. However, Spring Batch is not tied to any particular XML binding technology. Typical use is to delegate to [Spring OXM](#), which provides uniform abstraction for the most popular OXM technologies. The dependency on Spring OXM is optional and you can choose to implement Spring Batch specific interfaces if desired. The relationship to the technologies that OXM supports can be shown as the following:

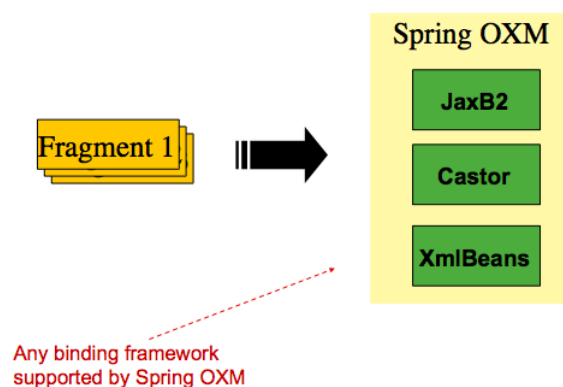

Figure 3.2: OXM Binding

Now with an introduction to OXM and how one can use XML fragments to represent records, let's take a closer look at readers and writers.

StaxEventItemReader

The `StaxEventItemReader` configuration provides a typical setup for the processing of records from an XML input stream. First, let's examine a set of XML records that the `StaxEventItemReader` can process.

```
<?xml version="1.0" encoding="UTF-8"?>
<records>
  <trade xmlns="http://springframework.org/batch/sample/io/oxm/domain">
    <isin>XYZ0001</isin>
    <quantity>5</quantity>
    <price>11.39</price>
    <customer>Customer1</customer>
  </trade>
  <trade xmlns="http://springframework.org/batch/sample/io/oxm/domain">
    <isin>XYZ0002</isin>
    <quantity>2</quantity>
    <price>72.99</price>
    <customer>Customer2c</customer>
  </trade>
  <trade xmlns="http://springframework.org/batch/sample/io/oxm/domain">
    <isin>XYZ0003</isin>
    <quantity>9</quantity>
    <price>99.99</price>
    <customer>Customer3</customer>
  </trade>
</records>
```

To be able to process the XML records the following is needed:

- Root Element Name - Name of the root element of the fragment that constitutes the object to be mapped. The example configuration demonstrates this with the value of `trade`.
- Resource - Spring Resource that represents the file to be read.
- Unmarshaller - Unmarshalling facility provided by Spring OXM for mapping the XML fragment to an object.

```
<bean id="itemReader" class="org.springframework.batch.item.xml.StaxEventItemReader">
  <property name="fragmentRootElementName" value="trade" />
  <property name="resource" value="data/iosample/input/input.xml" />
  <property name="unmarshaller" ref="tradeMarshaller" />
</bean>
```

Notice that in this example we have chosen to use an `XStreamMarshaller` which accepts an alias passed in as a map with the first key and value being the name of the fragment (i.e. root element) and the object type to bind. Then, similar to a `FieldSet`, the names of the other elements that map to fields within the object type are described as key/value pairs in the map. In the configuration file we can use a Spring configuration utility to describe the required alias as follows:

```

<bean id="tradeMarshaller"
      class="org.springframework.oxm.xstream.XStreamMarshaller">
  <property name="aliases">
    <util:map id="aliases">
      <entry key="trade"
            value="org.springframework.batch.sample.domain.Trade" />
      <entry key="price" value="java.math.BigDecimal" />
      <entry key="name" value="java.lang.String" />
    </util:map>
  </property>
</bean>

```

On input the reader reads the XML resource until it recognizes that a new fragment is about to start (by matching the tag name by default). The reader creates a standalone XML document from the fragment (or at least makes it appear so) and passes the document to a deserializer (typically a wrapper around a Spring OXM Unmarshaller) to map the XML to a Java object.

In summary, this procedure is analogous to the following scripted Java code which uses the injection provided by the Spring configuration:

```

StaxEventItemReader xmlStaxEventItemReader = new StaxEventItemReader()
Resource resource = new ByteArrayResource(xmlResource.getBytes())

Map aliases = new HashMap();
aliases.put("trade", "org.springframework.batch.sample.domain.Trade");
aliases.put("price", "java.math.BigDecimal");
aliases.put("customer", "java.lang.String");
XStreamMarshaller unmarshaller = new XStreamMarshaller();
unmarshaller.setAliases(aliases);
xmlStaxEventItemReader.setUnmarshaller(unmarshaller);
xmlStaxEventItemReader.setResource(resource);
xmlStaxEventItemReader.setFragmentRootElementName("trade");
xmlStaxEventItemReader.open(new ExecutionContext());

boolean hasNext = true

CustomerCredit credit = null;

while (hasNext) {
  credit = xmlStaxEventItemReader.read();
  if (credit == null) {
    hasNext = false;
  }
  else {
    System.out.println(credit);
  }
}

```

StaxEventItemWriter

Output works symmetrically to input. The `StaxEventItemWriter` needs a `Resource`, a marshaller, and a `rootTagName`. A Java object is passed to a marshaller (typically a standard Spring OXM Marshaller) which writes to a `Resource` using a custom event writer that filters the `StartDocument` and `EndDocument` events produced for each fragment by the OXM tools. We'll show this in an example using the `MarshallingEventWriterSerializer`. The Spring configuration for this setup looks as follows:

```

<bean id="itemWriter" class="org.springframework.batch.item.xml.StaxEventItemWriter">
  <property name="resource" ref="outputResource" />
  <property name="marshaller" ref="customerCreditMarshaller" />
  <property name="rootTagName" value="customers" />
  <property name="overwriteOutput" value="true" />
</bean>

```

The configuration sets up the three required properties and optionally sets the `overwriteOutput=true`, mentioned earlier in the chapter for specifying whether an existing file can be overwritten. It should be noted the marshaller used for the writer is the exact same as the one used in the reading example from earlier in the chapter:

```
<bean id="customerCreditMarshaller"
      class="org.springframework.xml.xstream.XStreamMarshaller">
  <property name="aliases">
    <util:map id="aliases">
      <entry key="customer"
            value="org.springframework.batch.sample.domain.CustomerCredit" />
      <entry key="credit" value="java.math.BigDecimal" />
      <entry key="name" value="java.lang.String" />
    </util:map>
  </property>
</bean>
```

To summarize with a Java example, the following code illustrates all of the points discussed, demonstrating the programmatic setup of the required properties:

```
StaxEventItemWriter staxItemWriter = new StaxEventItemWriter()
FileSystemResource resource = new FileSystemResource("data/outputFile.xml")

Map aliases = new HashMap();
aliases.put("customer", "org.springframework.batch.sample.domain.CustomerCredit");
aliases.put("credit", "java.math.BigDecimal");
aliases.put("name", "java.lang.String");
Marshaller marshaller = new XStreamMarshaller();
marshaller.setAliases(aliases);

staxItemWriter.setResource(resource);
staxItemWriter.setMarshaller(marshaller);
staxItemWriter.setRootTagName("trades");
staxItemWriter.setOverwriteOutput(true);

ExecutionContext executionContext = new ExecutionContext();
staxItemWriter.open(executionContext);
CustomerCredit credit = new CustomerCredit();
trade.setPrice(11.39);
credit.setName("Customer1");
staxItemWriter.write(trade);
```

6.8 Multi-File Input

It is a common requirement to process multiple files within a single `Step`. Assuming the files all have the same formatting, the `MultiResourceItemReader` supports this type of input for both XML and flat file processing. Consider the following files in a directory:

```
file-1.txt file-2.txt ignored.txt
```

`file-1.txt` and `file-2.txt` are formatted the same and for business reasons should be processed together. The `MultiResourceItemReader` can be used to read in both files by using wildcards:

```
<bean id="multiResourceReader" class="org.spr...MultiResourceItemReader">
  <property name="resources" value="classpath:data/input/file-*.txt" />
  <property name="delegate" ref="flatFileItemReader" />
</bean>
```

The referenced delegate is a simple `FlatFileItemReader`. The above configuration will read input from both files, handling rollback and restart scenarios. It should be noted that, as with any `ItemReader`, adding extra input (in this case a file) could cause potential issues when restarting. It is recommended that batch jobs work with their own individual directories until completed successfully.

6.9 Database

Like most enterprise application styles, a database is the central storage mechanism for batch. However, batch differs from other application styles due to the sheer size of the datasets with which the system must work. If a SQL statement returns 1 million rows, the result set probably holds all returned results in memory until all rows have been read. Spring Batch provides two types of solutions for this problem: Cursor and Paging database ItemReaders.

Cursor Based ItemReaders

Using a database cursor is generally the default approach of most batch developers, because it is the database's solution to the problem of 'streaming' relational data. The Java `ResultSet` class is essentially an object orientated mechanism for manipulating a cursor. A `ResultSet` maintains a cursor to the current row of data. Calling `next` on a `ResultSet` moves this cursor to the next row. Spring Batch cursor based `ItemReaders` open the a cursor on initialization, and move the cursor forward one row for every call to `read`, returning a mapped object that can be used for processing. The `close` method will then be called to ensure all resources are freed up. The Spring core `JdbcTemplate` gets around this problem by using the callback pattern to completely map all rows in a `ResultSet` and close before returning control back to the method caller. However, in batch this must wait until the step is complete. Below is a generic diagram of how a cursor based `ItemReader` works, and while a SQL statement is used as an example since it is so widely known, any technology could implement the basic approach:

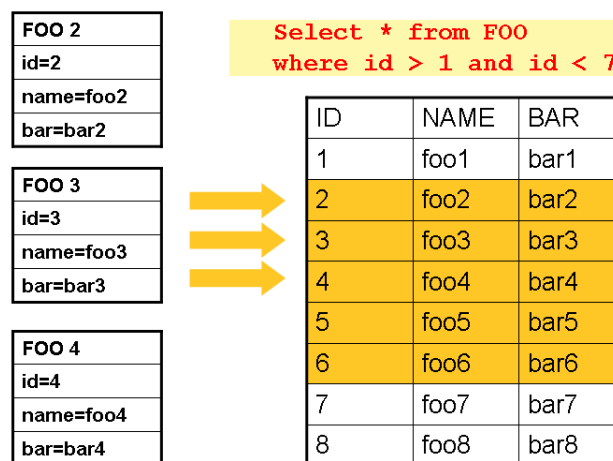

This example illustrates the basic pattern. Given a 'FOO' table, which has three columns: ID, NAME, and BAR, select all rows with an ID greater than 1 but less than 7. This puts the beginning of the cursor (row 1) on ID 2. The result of this row should be a completely mapped `Foo` object. Calling `read()` again moves the cursor to the next row, which is the `Foo` with an ID of 3. The results of these reads will be written out after each `read`, thus allowing the objects to be garbage collected (assuming no instance variables are maintaining references to them).

JdbcCursorItemReader

`JdbcCursorItemReader` is the `Jdbc` implementation of the cursor based technique. It works directly with a `ResultSet` and requires a SQL statement to run against a connection obtained from a `DataSource`. The following database schema will be used as an example:

```
CREATE TABLE CUSTOMER (
  ID BIGINT IDENTITY PRIMARY KEY,
  NAME VARCHAR(45),
  CREDIT FLOAT
);
```

Many people prefer to use a domain object for each row, so we'll use an implementation of the `RowMapper` interface to map a `CustomerCredit` object:

```
public class CustomerCreditRowMapper implements RowMapper {

    public static final String ID_COLUMN = "id";
    public static final String NAME_COLUMN = "name";
    public static final String CREDIT_COLUMN = "credit";

    public Object mapRow(ResultSet rs, int rowNum) throws SQLException {
        CustomerCredit customerCredit = new CustomerCredit();

        customerCredit.setId(rs.getInt(ID_COLUMN));
        customerCredit.setName(rs.getString(NAME_COLUMN));
        customerCredit.setCredit(rs.getBigDecimal(CREDIT_COLUMN));

        return customerCredit;
    }
}
```

Because `JdbcTemplate` is so familiar to users of Spring, and the `JdbcCursorItemReader` shares key interfaces with it, it is useful to see an example of how to read in this data with `JdbcTemplate`, in order to contrast it with the `ItemReader`. For the purposes of this example, let's assume there are 1,000 rows in the `CUSTOMER` database. The first example will be using `JdbcTemplate`:

```
//For simplicity sake, assume a dataSource has already been obtained
JdbcTemplate jdbcTemplate = new JdbcTemplate(dataSource);
List customerCredits = jdbcTemplate.query("SELECT ID, NAME, CREDIT from CUSTOMER",
                                         new CustomerCreditRowMapper());
```

After running this code snippet the `customerCredits` list will contain 1,000 `CustomerCredit` objects. In the query method, a connection will be obtained from the `DataSource`, the provided SQL will be run against it, and the `mapRow` method will be called for each row in the `ResultSet`. Let's contrast this with the approach of the `JdbcCursorItemReader`:

```
JdbcCursorItemReader itemReader = new JdbcCursorItemReader();
itemReader.setDataSource(dataSource);
itemReader.setSql("SELECT ID, NAME, CREDIT from CUSTOMER");
itemReader.setRowMapper(new CustomerCreditRowMapper());
int counter = 0;
ExecutionContext executionContext = new ExecutionContext();
itemReader.open(executionContext);
Object customerCredit = new Object();
while(customerCredit != null){
    customerCredit = itemReader.read();
    counter++;
}
itemReader.close(executionContext);
```

After running this code snippet the counter will equal 1,000. If the code above had put the returned `customerCredit` into a list, the result would have been exactly the same as with the `JdbcTemplate` example. However, the big advantage of the `ItemReader` is that it allows items to be 'streamed'. The `read` method can be called once, and the item written out via an `ItemWriter`, and then the next item obtained via `read`. This allows item reading and writing to be done in 'chunks' and committed periodically, which is the essence of high performance batch processing. Furthermore, it is very easily configured for injection into a Spring Batch `Step`:

```

<bean id="itemReader" class="org.spr...JdbcCursorItemReader">
  <property name="dataSource" ref="dataSource"/>
  <property name="sql" value="select ID, NAME, CREDIT from CUSTOMER"/>
  <property name="rowMapper">
    <bean class="org.springframework.batch.sample.domain.CustomerCreditRowMapper"/>
  </property>
</bean>

```

Additional Properties

Because there are so many varying options for opening a cursor in Java, there are many properties on the `JdbcCursorItemReader` that can be set:

Table 6.2. *JdbcCursorItemReader* Properties

ignoreWarnings	Determines whether or not <code>SQLWarnings</code> are logged or cause an exception - default is true
fetchSize	Gives the <code>Jdbc</code> driver a hint as to the number of rows that should be fetched from the database when more rows are needed by the <code>ResultSet</code> object used by the <code>ItemReader</code> . By default, no hint is given.
maxRows	Sets the limit for the maximum number of rows the underlying <code>ResultSet</code> can hold at any one time.
queryTimeout	Sets the number of seconds the driver will wait for a <code>Statement</code> object to execute to the given number of seconds. If the limit is exceeded, a <code>DataAccessException</code> is thrown. (Consult your driver vendor documentation for details).
verifyCursorPosition	Because the same <code>ResultSet</code> held by the <code>ItemReader</code> is passed to the <code>RowMapper</code> , it is possible for users to call <code>ResultSet.next()</code> themselves, which could cause issues with the reader's internal count. Setting this value to true will cause an exception to be thrown if the cursor position is not the same after the <code>RowMapper</code> call as it was before.
saveState	Indicates whether or not the reader's state should be saved in the <code>ExecutionContext</code> provided by <code>ItemStream#update(ExecutionContext)</code> . The default value is true.
driverSupportsAbsolute	Defaults to false. Indicates whether the <code>Jdbc</code> driver supports setting the absolute row on a <code>ResultSet</code> . It is recommended that this is set to true for <code>Jdbc</code> drivers that supports <code>ResultSet.absolute()</code> as it may improve performance, especially if a step fails while working with a large data set.

setUseSharedExtendedConnection

Defaults to false. Indicates whether the connection used for the cursor should be used by all other processing thus sharing the same transaction. If this is set to false, which is the default, then the cursor will be opened using its own connection and will not participate in any transactions started for the rest of the step processing. If you set this flag to true then you must wrap the `DataSource` in an `ExtendedConnectionDataSourceProxy` to prevent the connection from being closed and released after each commit. When you set this option to true then the statement used to open the cursor will be created with both 'READ_ONLY' and 'HOLD_CURSORS_OVER_COMMIT' options. This allows holding the cursor open over transaction start and commits performed in the step processing. To use this feature you need a database that supports this and a Jdbc driver supporting Jdbc 3.0 or later.

HibernateCursorItemReader

Just as normal Spring users make important decisions about whether or not to use ORM solutions, which affect whether or not they use a `JdbcTemplate` or a `HibernateTemplate`, Spring Batch users have the same options. `HibernateCursorItemReader` is the Hibernate implementation of the cursor technique. Hibernate's usage in batch has been fairly controversial. This has largely been because Hibernate was originally developed to support online application styles. However, that doesn't mean it can't be used for batch processing. The easiest approach for solving this problem is to use a `StatelessSession` rather than a standard session. This removes all of the caching and dirty checking hibernate employs that can cause issues in a batch scenario. For more information on the differences between stateless and normal hibernate sessions, refer to the documentation of your specific hibernate release. The `HibernateCursorItemReader` allows you to declare an HQL statement and pass in a `SessionFactory`, which will pass back one item per call to `read` in the same basic fashion as the `JdbcCursorItemReader`. Below is an example configuration using the same 'customer credit' example as the JDBC reader:

```

HibernateCursorItemReader itemReader = new HibernateCursorItemReader();
itemReader.setQueryString("from CustomerCredit");
//For simplicity sake, assume sessionFactory already obtained.
itemReader.setSessionFactory(sessionFactory);
itemReader.setUseStatelessSession(true);
int counter = 0;
ExecutionContext executionContext = new ExecutionContext();
itemReader.open(executionContext);
Object customerCredit = new Object();
while(customerCredit != null){
    customerCredit = itemReader.read();
    counter++;
}
itemReader.close(executionContext);

```

This configured `ItemReader` will return `CustomerCredit` objects in the exact same manner as described by the `JdbcCursorItemReader`, assuming hibernate mapping files have been created

correctly for the Customer table. The 'useStatelessSession' property defaults to true, but has been added here to draw attention to the ability to switch it on or off. It is also worth noting that the fetchSize of the underlying cursor can be set via the setFetchSize property. As with `JdbcCursorItemReader`, configuration is straightforward:

```
<bean id="itemReader"
      class="org.springframework.batch.item.database.HibernateCursorItemReader">
  <property name="sessionFactory" ref="sessionFactory" />
  <property name="queryString" value="from CustomerCredit" />
</bean>
```

StoredProcedureItemReader

Sometimes it is necessary to obtain the cursor data using a stored procedure. The `StoredProcedureItemReader` works like the `JdbcCursorItemReader` except that instead of executing a query to obtain a cursor we execute a stored procedure that returns a cursor. The stored procedure can return the cursor in three different ways:

1. as a returned `ResultSet` (used by SQL Server, Sybase, DB2, Derby and MySQL)
2. as a ref-cursor returned as an out parameter (used by Oracle and PostgreSQL)
3. as the return value of a stored function call

Below is a basic example configuration using the same 'customer credit' example as earlier:

```
<bean id="reader" class="o.s.batch.item.database.StoredProcedureItemReader">
  <property name="dataSource" ref="dataSource"/>
  <property name="procedureName" value="sp_customer_credit"/>
  <property name="rowMapper">
    <bean class="org.springframework.batch.sample.domain.CustomerCreditRowMapper"/>
  </property>
</bean>
```

This example relies on the stored procedure to provide a `ResultSet` as a returned result (option 1 above).

If the stored procedure returned a ref-cursor (option 2) then we would need to provide the position of the out parameter that is the returned ref-cursor. Here is an example where the first parameter is the returned ref-cursor:

```
<bean id="reader" class="o.s.batch.item.database.StoredProcedureItemReader">
  <property name="dataSource" ref="dataSource"/>
  <property name="procedureName" value="sp_customer_credit"/>
  <property name="refCursorPosition" value="1"/>
  <property name="rowMapper">
    <bean class="org.springframework.batch.sample.domain.CustomerCreditRowMapper"/>
  </property>
</bean>
```

If the cursor was returned from a stored function (option 3) we would need to set the property "function" to true. It defaults to false. Here is what that would look like:

```
<bean id="reader" class="o.s.batch.item.database.StoredProcedureItemReader">
  <property name="dataSource" ref="dataSource"/>
  <property name="procedureName" value="sp_customer_credit"/>
  <property name="function" value="true"/>
  <property name="rowMapper">
    <bean class="org.springframework.batch.sample.domain.CustomerCreditRowMapper"/>
  </property>
</bean>
```

In all of these cases we need to define a `RowMapper` as well as a `DataSource` and the actual procedure name.

If the stored procedure or function takes in parameter then they must be declared and set via the `parameters` property. Here is an example for Oracle that declares three parameters. The first one is the out parameter that returns the ref-cursor, the second and third are in parameters that takes a value of type `INTEGER`:

```
<bean id="reader" class="o.s.batch.item.database.StoredProcedureItemReader">
  <property name="dataSource" ref="dataSource"/>
  <property name="procedureName" value="spring.cursor_func"/>
  <property name="parameters">
    <list>
      <bean class="org.springframework.jdbc.core.SqlOutParameter">
        <constructor-arg index="0" value="newid"/>
        <constructor-arg index="1">
          <util:constant static-field="oracle.jdbc.OracleTypes.CURSOR"/>
        </constructor-arg>
      </bean>
      <bean class="org.springframework.jdbc.core.SqlParameter">
        <constructor-arg index="0" value="amount"/>
        <constructor-arg index="1">
          <util:constant static-field="java.sql.Types.INTEGER"/>
        </constructor-arg>
      </bean>
      <bean class="org.springframework.jdbc.core.SqlParameter">
        <constructor-arg index="0" value="custid"/>
        <constructor-arg index="1">
          <util:constant static-field="java.sql.Types.INTEGER"/>
        </constructor-arg>
      </bean>
    </list>
  </property>
  <property name="refCursorPosition" value="1"/>
  <property name="rowMapper" ref="rowMapper"/>
  <property name="preparedStatementSetter" ref="parameterSetter"/>
</bean>
```

In addition to the parameter declarations we need to specify a `PreparedStatementSetter` implementation that sets the parameter values for the call. This works the same as for the `JdbcCursorItemReader` above. All the additional properties listed in the section called “Additional Properties” apply to the `StoredProcedureItemReader` as well.

Paging ItemReaders

An alternative to using a database cursor is executing multiple queries where each query is bringing back a portion of the results. We refer to this portion as a page. Each query that is executed must specify the starting row number and the number of rows that we want returned for the page.

JdbcPagingItemReader

One implementation of a paging `ItemReader` is the `JdbcPagingItemReader`. The `JdbcPagingItemReader` needs a `PagingQueryProvider` responsible for providing the SQL queries used to retrieve the rows making up a page. Since each database has its own strategy for providing paging support, we need to use a different `PagingQueryProvider` for each supported database type. There is also the `SqlPagingQueryProviderFactoryBean` that will auto-detect the database that is being used and determine the appropriate `PagingQueryProvider` implementation. This simplifies the configuration and is the recommended best practice.

The `SqlPagingQueryProviderFactoryBean` requires that you specify a select clause and a from clause. You can also provide an optional where clause. These clauses will be used to build an SQL statement combined with the required `sortKey`.

After the reader has been opened, it will pass back one item per call to `read` in the same basic fashion as any other `ItemReader`. The paging happens behind the scenes when additional rows are needed.

Below is an example configuration using a similar 'customer credit' example as the cursor based `ItemReaders` above:

```
<bean id="itemReader" class="org.spr...JdbcPagingItemReader">
  <property name="dataSource" ref="dataSource"/>
  <property name="queryProvider">
    <bean class="org.spr...SqlPagingQueryProviderFactoryBean">
      <property name="selectClause" value="select id, name, credit"/>
      <property name="fromClause" value="from customer"/>
      <property name="whereClause" value="where status=:status"/>
      <property name="sortKey" value="id"/>
    </bean>
  </property>
  <property name="parameterValues">
    <map>
      <entry key="status" value="NEW"/>
    </map>
  </property>
  <property name="pageSize" value="1000"/>
  <property name="rowMapper" ref="customerMapper"/>
</bean>
```

This configured `ItemReader` will return `CustomerCredit` objects using the `RowMapper` that must be specified. The 'pageSize' property determines the number of entities read from the database for each query execution.

The 'parameterValues' property can be used to specify a Map of parameter values for the query. If you use named parameters in the where clause the key for each entry should match the name of the named parameter. If you use a traditional '?' placeholder then the key for each entry should be the number of the placeholder, starting with 1.

JpaPagingItemReader

Another implementation of a paging `ItemReader` is the `JpaPagingItemReader`. JPA doesn't have a concept similar to the Hibernate `StatelessSession` so we have to use other features provided by the JPA specification. Since JPA supports paging, this is a natural choice when it comes to using JPA for batch processing. After each page is read, the entities will become detached and the persistence context will be cleared in order to allow the entities to be garbage collected once the page is processed.

The `JpaPagingItemReader` allows you to declare a JPQL statement and pass in a `EntityManagerFactory`. It will then pass back one item per call to `read` in the same basic fashion as any other `ItemReader`. The paging happens behind the scenes when additional entities are needed. Below is an example configuration using the same 'customer credit' example as the JDBC reader above:

```
<bean id="itemReader" class="org.spr...JpaPagingItemReader">
  <property name="entityManagerFactory" ref="entityManagerFactory"/>
  <property name="queryString" value="select c from CustomerCredit c"/>
  <property name="pageSize" value="1000"/>
</bean>
```

This configured `ItemReader` will return `CustomerCredit` objects in the exact same manner as described by the `JdbcPagingItemReader` above, assuming the `Customer` object has the correct JPA

annotations or ORM mapping file. The 'pageSize' property determines the number of entities read from the database for each query execution.

IbatisPagingItemReader

Note

This reader is deprecated as of Spring Batch 3.0.

If you use IBATIS for your data access then you can use the `IbatisPagingItemReader` which, as the name indicates, is an implementation of a paging `ItemReader`. IBATIS doesn't have direct support for reading rows in pages but by providing a couple of standard variables you can add paging support to your IBATIS queries.

Here is an example of a configuration for a `IbatisPagingItemReader` reading `CustomerCredits` as in the examples above:

```
<bean id="itemReader" class="org.spr...IbatisPagingItemReader">
  <property name="sqlMapClient" ref="sqlMapClient"/>
  <property name="queryId" value="getPagedCustomerCredits"/>
  <property name="pageSize" value="1000"/>
</bean>
```

The `IbatisPagingItemReader` configuration above references an IBATIS query called "getPagedCustomerCredits". Here is an example of what that query should look like for MySQL.

```
<select id="getPagedCustomerCredits" resultMap="customerCreditResult">
  select id, name, credit from customer order by id asc LIMIT #_skiprows#, #_pagesize#
</select>
```

The `_skiprows` and `_pagesize` variables are provided by the `IbatisPagingItemReader` and there is also a `_page` variable that can be used if necessary. The syntax for the paging queries varies with the database used. Here is an example for Oracle (unfortunately we need to use CDATA for some operators since this belongs in an XML document):

```
<select id="getPagedCustomerCredits" resultMap="customerCreditResult">
  select * from (
    select * from (
      select t.id, t.name, t.credit, ROWNUM ROWNUM_ from customer t order by id
    ) where ROWNUM_ <![CDATA[ > ]]> ( #_page# * #_pagesize# )
  ) where ROWNUM <![CDATA[ <= ]]> #_pagesize#
</select>
```

Database ItemWriters

While both Flat Files and XML have specific `ItemWriters`, there is no exact equivalent in the database world. This is because transactions provide all the functionality that is needed. `ItemWriters` are necessary for files because they must act as if they're transactional, keeping track of written items and flushing or clearing at the appropriate times. Databases have no need for this functionality, since the write is already contained in a transaction. Users can create their own DAOs that implement the `ItemWriter` interface or use one from a custom `ItemWriter` that's written for generic processing concerns, either way, they should work without any issues. One thing to look out for is the performance and error handling capabilities that are provided by batching the outputs. This is most common when using hibernate as an `ItemWriter`, but could have the same issues when using Jdbc batch mode. Batching database output doesn't have any inherent flaws, assuming we are careful to flush and there are no errors in the data. However, any errors while writing out can cause confusion because there is no way to know which individual item caused an exception, or even if any individual item was responsible, as illustrated below:

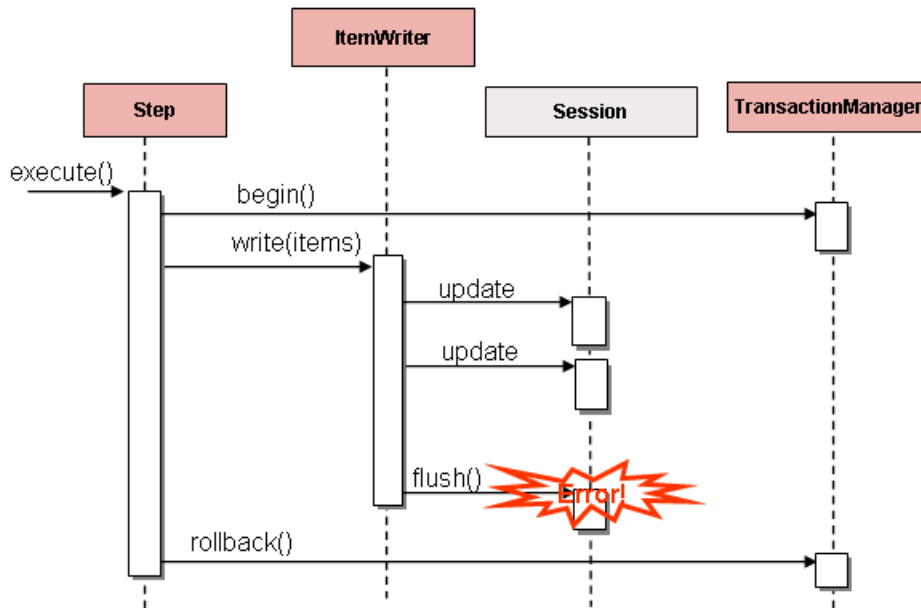

If items are buffered before being written out, any errors encountered will not be thrown until the buffer is flushed just before a commit. For example, let's assume that 20 items will be written per chunk, and the 15th item throws a `DataIntegrityViolationException`. As far as the `Step` is concerned, all 20 items will be written out successfully, since there's no way to know that an error will occur until they are actually written out. Once `Session#flush()` is called, the buffer will be emptied and the exception will be hit. At this point, there's nothing the `Step` can do, the transaction must be rolled back. Normally, this exception might cause the `Item` to be skipped (depending upon the skip/retry policies), and then it won't be written out again. However, in the batched scenario, there's no way for it to know which item caused the issue, the whole buffer was being written out when the failure happened. The only way to solve this issue is to flush after each item:

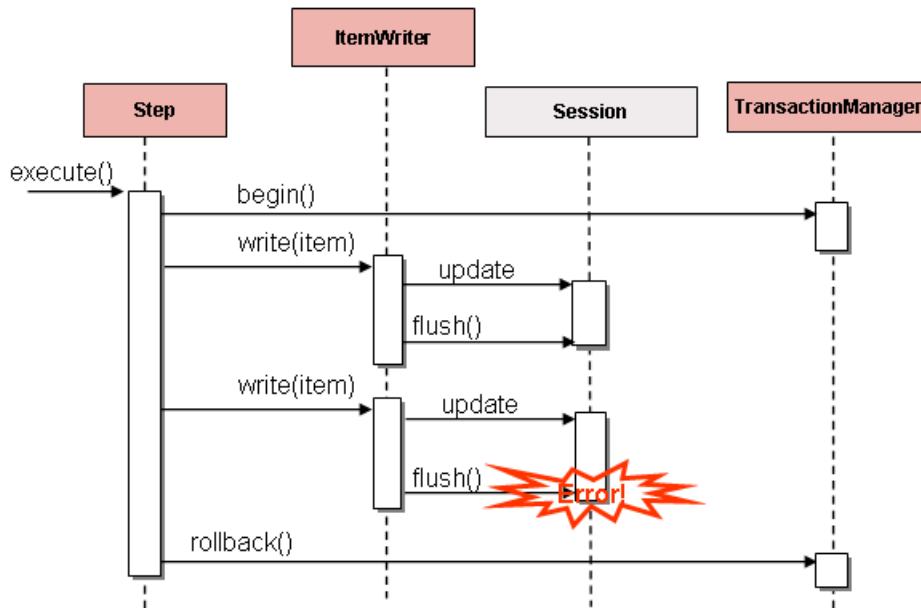

This is a common use case, especially when using Hibernate, and the simple guideline for implementations of `ItemWriter`, is to flush on each call to `write()`. Doing so allows for items to be skipped reliably, with Spring Batch taking care internally of the granularity of the calls to `ItemWriter` after an error.

6.10 Reusing Existing Services

Batch systems are often used in conjunction with other application styles. The most common is an online system, but it may also support integration or even a thick client application by moving necessary bulk data that each application style uses. For this reason, it is common that many users want to reuse existing DAOs or other services within their batch jobs. The Spring container itself makes this fairly easy by allowing any necessary class to be injected. However, there may be cases where the existing service needs to act as an `ItemReader` or `ItemWriter`, either to satisfy the dependency of another Spring Batch class, or because it truly is the main `ItemReader` for a step. It is fairly trivial to write an adaptor class for each service that needs wrapping, but because it is such a common concern, Spring Batch provides implementations: `ItemReaderAdapter` and `ItemWriterAdapter`. Both classes implement the standard Spring method invoking the delegate pattern and are fairly simple to set up. Below is an example of the reader:

```

<bean id="itemReader" class="org.springframework.batch.item.adapter.ItemReaderAdapter">
  <property name="targetObject" ref="fooService" />
  <property name="targetMethod" value="generateFoo" />
</bean>

<bean id="fooService" class="org.springframework.batch.item.sample.FooService" />

```

One important point to note is that the contract of the `targetMethod` must be the same as the contract for `read`: when exhausted it will return null, otherwise an `Object`. Anything else will prevent the framework from knowing when processing should end, either causing an infinite loop or incorrect failure, depending upon the implementation of the `ItemWriter`. The `ItemWriter` implementation is equally as simple:

```

<bean id="itemWriter" class="org.springframework.batch.item.adapter.ItemWriterAdapter">
  <property name="targetObject" ref="fooService" />
  <property name="targetMethod" value="processFoo" />
</bean>

<bean id="fooService" class="org.springframework.batch.item.sample.FooService" />

```

6.11 Validating Input

During the course of this chapter, multiple approaches to parsing input have been discussed. Each major implementation will throw an exception if it is not 'well-formed'. The `FixedLengthTokenizer` will throw an exception if a range of data is missing. Similarly, attempting to access an index in a `RowMapper` or `FieldSetMapper` that doesn't exist or is in a different format than the one expected will cause an exception to be thrown. All of these types of exceptions will be thrown before `read` returns. However, they don't address the issue of whether or not the returned item is valid. For example, if one of the fields is an age, it obviously cannot be negative. It will parse correctly, because it existed and is a number, but it won't cause an exception. Since there are already a plethora of Validation frameworks, Spring Batch does not attempt to provide yet another, but rather provides a very simple interface that can be implemented by any number of frameworks:

```

public interface Validator {

    void validate(Object value) throws ValidationException;

}

```

The contract is that the `validate` method will throw an exception if the object is invalid, and return normally if it is valid. Spring Batch provides an out of the box `ItemProcessor`:

```

<bean class="org.springframework.batch.item.validator.ValidatorItemProcessor">
  <property name="validator" ref="validator" />
</bean>

<bean id="validator"
  class="org.springframework.batch.item.validator.SpringValidator">
  <property name="validator">
    <bean id="orderValidator"
      class="org.springframework.validation.valang.ValangValidator">
      <property name="valang">
        <value>
          <![CDATA[
{ orderId : ? > 0 AND ? <= 999999999 : 'Incorrect order ID' : 'error.order.id' }
{ totalLines : ? = size(lineItems) : 'Bad count of order lines'
  : 'error.order.lines.badcount' }
{ customer.registered : customer.businessCustomer = FALSE OR ? = TRUE
  : 'Business customer must be registered'
  : 'error.customer.registration' }
{ customer.companyName : customer.businessCustomer = FALSE OR ? HAS TEXT
  : 'Company name for business customer is mandatory'
  : 'error.customer.companyname' }
]]>
        </value>
      </property>
    </bean>
  </property>
</bean>

```

This simple example shows a simple `ValangValidator` that is used to validate an order object. The intent is not to show Valang functionality as much as to show how a validator could be added.

6.12 Preventing State Persistence

By default, all of the `ItemReader` and `ItemWriter` implementations store their current state in the `ExecutionContext` before it is committed. However, this may not always be the desired behavior. For example, many developers choose to make their database readers 'rerunnable' by using a process indicator. An extra column is added to the input data to indicate whether or not it has been processed. When a particular record is being read (or written out) the processed flag is flipped from false to true. The SQL statement can then contain an extra statement in the where clause, such as "where PROCESSED_IND = false", thereby ensuring that only unprocessed records will be returned in the case of a restart. In this scenario, it is preferable to not store any state, such as the current row number, since it will be irrelevant upon restart. For this reason, all readers and writers include the 'saveState' property:

```
<bean id="playerSummarizationSource" class="org.spr...JdbcCursorItemReader">
  <property name="dataSource" ref="dataSource" />
  <property name="rowMapper">
    <bean class="org.springframework.batch.sample.PlayerSummaryMapper" />
  </property>
  <property name="saveState" value="false" />
  <property name="sql">
    <value>
      SELECT games.player_id, games.year_no, SUM(COMPLETES),
      SUM(ATTEMPTS), SUM(PASSING_YARDS), SUM(PASSING_TD),
      SUM(INTERCEPTIONS), SUM(RUSHES), SUM(RUSH_YARDS),
      SUM(RECEPTIONS), SUM(RECEPTIONS_YARDS), SUM(TOTAL_TD)
      from games, players where players.player_id =
      games.player_id group by games.player_id, games.year_no
    </value>
  </property>
</bean>
```

The `ItemReader` configured above will not make any entries in the `ExecutionContext` for any executions in which it participates.

6.13 Creating Custom ItemReaders and ItemWriters

So far in this chapter the basic contracts that exist for reading and writing in Spring Batch and some common implementations have been discussed. However, these are all fairly generic, and there are many potential scenarios that may not be covered by out of the box implementations. This section will show, using a simple example, how to create a custom `ItemReader` and `ItemWriter` implementation and implement their contracts correctly. The `ItemReader` will also implement `ItemStream`, in order to illustrate how to make a reader or writer restartable.

Custom ItemReader Example

For the purpose of this example, a simple `ItemReader` implementation that reads from a provided list will be created. We'll start out by implementing the most basic contract of `ItemReader`, `read`:

```
public class CustomItemReader<T> implements ItemReader<T>{

    List<T> items;

    public CustomItemReader(List<T> items) {
        this.items = items;
    }

    public T read() throws Exception, UnexpectedInputException,
        NoWorkFoundException, ParseException {

        if (!items.isEmpty()) {
            return items.remove(0);
        }
        return null;
    }
}
```

This very simple class takes a list of items, and returns them one at a time, removing each from the list. When the list is empty, it returns null, thus satisfying the most basic requirements of an `ItemReader`, as illustrated below:

```
List<String> items = new ArrayList<String>();
items.add("1");
items.add("2");
items.add("3");

ItemReader itemReader = new CustomItemReader<String>(items);
assertEquals("1", itemReader.read());
assertEquals("2", itemReader.read());
assertEquals("3", itemReader.read());
assertNull(itemReader.read());
```

Making the `ItemReader` Restartable

The final challenge now is to make the `ItemReader` restartable. Currently, if the power goes out, and processing begins again, the `ItemReader` must start at the beginning. This is actually valid in many scenarios, but it is sometimes preferable that a batch job starts where it left off. The key discriminant is often whether the reader is stateful or stateless. A stateless reader does not need to worry about restartability, but a stateful one has to try and reconstitute its last known state on restart. For this reason, we recommend that you keep custom readers stateless if possible, so you don't have to worry about restartability.

If you do need to store state, then the `ItemStream` interface should be used:

```

public class CustomItemReader<T> implements ItemReader<T>, ItemStream {

    List<T> items;
    int currentIndex = 0;
    private static final String CURRENT_INDEX = "current.index";

    public CustomItemReader(List<T> items) {
        this.items = items;
    }

    public T read() throws Exception, UnexpectedInputException,
        ParseException {

        if (currentIndex < items.size()) {
            return items.get(currentIndex++);
        }

        return null;
    }

    public void open(ExecutionContext executionContext) throws ItemStreamException {
        if (executionContext.containsKey(CURRENT_INDEX)) {
            currentIndex = new Long(executionContext.getLong(CURRENT_INDEX)).intValue();
        }
        else {
            currentIndex = 0;
        }
    }

    public void update(ExecutionContext executionContext) throws ItemStreamException {
        executionContext.putLong(CURRENT_INDEX, new Long(currentIndex).longValue());
    }

    public void close() throws ItemStreamException {}
}

```

On each call to the `ItemStream` `update` method, the current index of the `ItemReader` will be stored in the provided `ExecutionContext` with a key of 'current.index'. When the `ItemStream` `open` method is called, the `ExecutionContext` is checked to see if it contains an entry with that key. If the key is found, then the current index is moved to that location. This is a fairly trivial example, but it still meets the general contract:

```

ExecutionContext executionContext = new ExecutionContext();
((ItemStream)itemReader).open(executionContext);
assertEquals("1", itemReader.read());
((ItemStream)itemReader).update(executionContext);

List<String> items = new ArrayList<String>();
items.add("1");
items.add("2");
items.add("3");
itemReader = new CustomItemReader<String>(items);

((ItemStream)itemReader).open(executionContext);
assertEquals("2", itemReader.read());

```

Most `ItemReaders` have much more sophisticated restart logic. The `JdbcCursorItemReader`, for example, stores the row id of the last processed row in the `Cursor`.

It is also worth noting that the key used within the `ExecutionContext` should not be trivial. That is because the same `ExecutionContext` is used for all `ItemStreams` within a `Step`. In most cases, simply prepending the key with the class name should be enough to guarantee uniqueness. However, in the rare cases where two of the same type of `ItemStream` are used in the same step (which can happen if two files are need for output) then a more unique name will be needed. For this reason, many

of the Spring Batch `ItemReader` and `ItemWriter` implementations have a `setName()` property that allows this key name to be overridden.

Custom `ItemWriter` Example

Implementing a Custom `ItemWriter` is similar in many ways to the `ItemReader` example above, but differs in enough ways as to warrant its own example. However, adding restartability is essentially the same, so it won't be covered in this example. As with the `ItemReader` example, a `List` will be used in order to keep the example as simple as possible:

```
public class CustomItemWriter<T> implements ItemWriter<T> {  
  
    List<T> output = TransactionAwareProxyFactory.createTransactionalList();  
  
    public void write(List<? extends T> items) throws Exception {  
        output.addAll(items);  
    }  
  
    public List<T> getOutput() {  
        return output;  
    }  
}
```

Making the `ItemWriter` Restartable

To make the `ItemWriter` restartable we would follow the same process as for the `ItemReader`, adding and implementing the `ItemStream` interface to synchronize the execution context. In the example we might have to count the number of items processed and add that as a footer record. If we needed to do that, we could implement `ItemStream` in our `ItemWriter` so that the counter was reconstituted from the execution context if the stream was re-opened.

In many realistic cases, custom `ItemWriters` also delegate to another writer that itself is restartable (e.g. when writing to a file), or else it writes to a transactional resource so doesn't need to be restartable because it is stateless. When you have a stateful writer you should probably also be sure to implement `ItemStream` as well as `ItemWriter`. Remember also that the client of the writer needs to be aware of the `ItemStream`, so you may need to register it as a stream in the configuration xml.

7. Scaling and Parallel Processing

Many batch processing problems can be solved with single threaded, single process jobs, so it is always a good idea to properly check if that meets your needs before thinking about more complex implementations. Measure the performance of a realistic job and see if the simplest implementation meets your needs first: you can read and write a file of several hundred megabytes in well under a minute, even with standard hardware.

When you are ready to start implementing a job with some parallel processing, Spring Batch offers a range of options, which are described in this chapter, although some features are covered elsewhere. At a high level there are two modes of parallel processing: single process, multi-threaded; and multi-process. These break down into categories as well, as follows:

- Multi-threaded Step (single process)
- Parallel Steps (single process)
- Remote Chunking of Step (multi process)
- Partitioning a Step (single or multi process)

Next we review the single-process options first, and then the multi-process options.

7.1 Multi-threaded Step

The simplest way to start parallel processing is to add a `TaskExecutor` to your Step configuration, e.g. as an attribute of the `tasklet`:

```
<step id="loading">
  <tasklet task-executor="taskExecutor">...</tasklet>
</step>
```

In this example the `taskExecutor` is a reference to another bean definition, implementing the `TaskExecutor` interface. `TaskExecutor` is a standard Spring interface, so consult the Spring User Guide for details of available implementations. The simplest multi-threaded `TaskExecutor` is a `SimpleAsyncTaskExecutor`.

The result of the above configuration will be that the Step executes by reading, processing and writing each chunk of items (each commit interval) in a separate thread of execution. Note that this means there is no fixed order for the items to be processed, and a chunk might contain items that are non-consecutive compared to the single-threaded case. In addition to any limits placed by the task executor (e.g. if it is backed by a thread pool), there is a throttle limit in the tasklet configuration which defaults to 4. You may need to increase this to ensure that a thread pool is fully utilised, e.g.

```
<step id="loading"> <tasklet
  task-executor="taskExecutor"
  throttle-limit="20">...</tasklet>
</step>
```

Note also that there may be limits placed on concurrency by any pooled resources used in your step, such as a `DataSource`. Be sure to make the pool in those resources at least as large as the desired number of concurrent threads in the step.

There are some practical limitations of using multi-threaded Steps for some common Batch use cases. Many participants in a Step (e.g. readers and writers) are stateful, and if the state is not segregated by

thread, then those components are not usable in a multi-threaded Step. In particular most of the off-the-shelf readers and writers from Spring Batch are not designed for multi-threaded use. It is, however, possible to work with stateless or thread safe readers and writers, and there is a sample (`parallelJob`) in the Spring Batch Samples that show the use of a process indicator (see Section 6.12, “Preventing State Persistence”) to keep track of items that have been processed in a database input table.

Spring Batch provides some implementations of `ItemWriter` and `ItemReader`. Usually they say in the Javadocs if they are thread safe or not, or what you have to do to avoid problems in a concurrent environment. If there is no information in Javadocs, you can check the implementation to see if there is any state. If a reader is not thread safe, it may still be efficient to use it in your own synchronizing delegator. You can synchronize the call to `read()` and as long as the processing and writing is the most expensive part of the chunk your step may still complete much faster than in a single threaded configuration.

7.2 Parallel Steps

As long as the application logic that needs to be parallelized can be split into distinct responsibilities, and assigned to individual steps then it can be parallelized in a single process. Parallel Step execution is easy to configure and use, for example, to execute steps (`step1`, `step2`) in parallel with `step3`, you could configure a flow like this:

```
<job id="job1">
  <split id="split1" task-executor="taskExecutor" next="step4">
    <flow>
      <step id="step1" parent="s1" next="step2"/>
      <step id="step2" parent="s2"/>
    </flow>
    <flow>
      <step id="step3" parent="s3"/>
    </flow>
  </split>
  <step id="step4" parent="s4"/>
</job>

<beans:bean id="taskExecutor" class="org.spr...SimpleAsyncTaskExecutor"/>
```

The configurable "task-executor" attribute is used to specify which `TaskExecutor` implementation should be used to execute the individual flows. The default is `SyncTaskExecutor`, but an asynchronous `TaskExecutor` is required to run the steps in parallel. Note that the job will ensure that every flow in the split completes before aggregating the exit statuses and transitioning.

See the section on the section called “Split Flows” for more detail.

7.3 Remote Chunking

In Remote Chunking the Step processing is split across multiple processes, communicating with each other through some middleware. Here is a picture of the pattern in action:

Remote Chunking

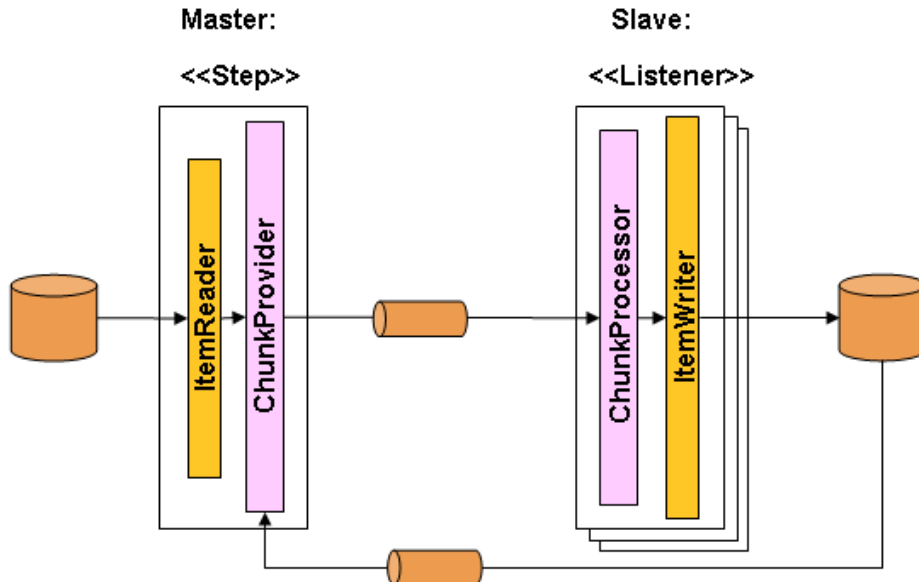

The Master component is a single process, and the Slaves are multiple remote processes. Clearly this pattern works best if the Master is not a bottleneck, so the processing must be more expensive than the reading of items (this is often the case in practice).

The Master is just an implementation of a Spring Batch `Step`, with the `ItemWriter` replaced with a generic version that knows how to send chunks of items to the middleware as messages. The Slaves are standard listeners for whatever middleware is being used (e.g. with JMS they would be `MessageListeners`), and their role is to process the chunks of items using a standard `ItemWriter` or `ItemProcessor` plus `ItemWriter`, through the `ChunkProcessor` interface. One of the advantages of using this pattern is that the reader, processor and writer components are off-the-shelf (the same as would be used for a local execution of the step). The items are divided up dynamically and work is shared through the middleware, so if the listeners are all eager consumers, then load balancing is automatic.

The middleware has to be durable, with guaranteed delivery and single consumer for each message. JMS is the obvious candidate, but other options exist in the grid computing and shared memory product space (e.g. Java Spaces).

7.4 Partitioning

Spring Batch also provides an SPI for partitioning a `Step` execution and executing it remotely. In this case the remote participants are simply `Step` instances that could just as easily have been configured and used for local processing. Here is a picture of the pattern in action:

Partitioning Overview

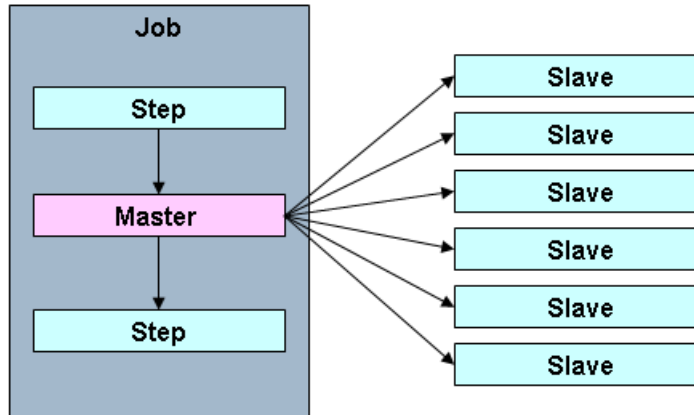

The Job is executing on the left hand side as a sequence of Steps, and one of the Steps is labelled as a Master. The Slaves in this picture are all identical instances of a Step, which could in fact take the place of the Master resulting in the same outcome for the Job. The Slaves are typically going to be remote services, but could also be local threads of execution. The messages sent by the Master to the Slaves in this pattern do not need to be durable, or have guaranteed delivery: Spring Batch meta-data in the `JobRepository` will ensure that each Slave is executed once and only once for each Job execution.

The SPI in Spring Batch consists of a special implementation of Step (the `PartitionStep`), and two strategy interfaces that need to be implemented for the specific environment. The strategy interfaces are `PartitionHandler` and `StepExecutionSplitter`, and their role is show in the sequence diagram below:

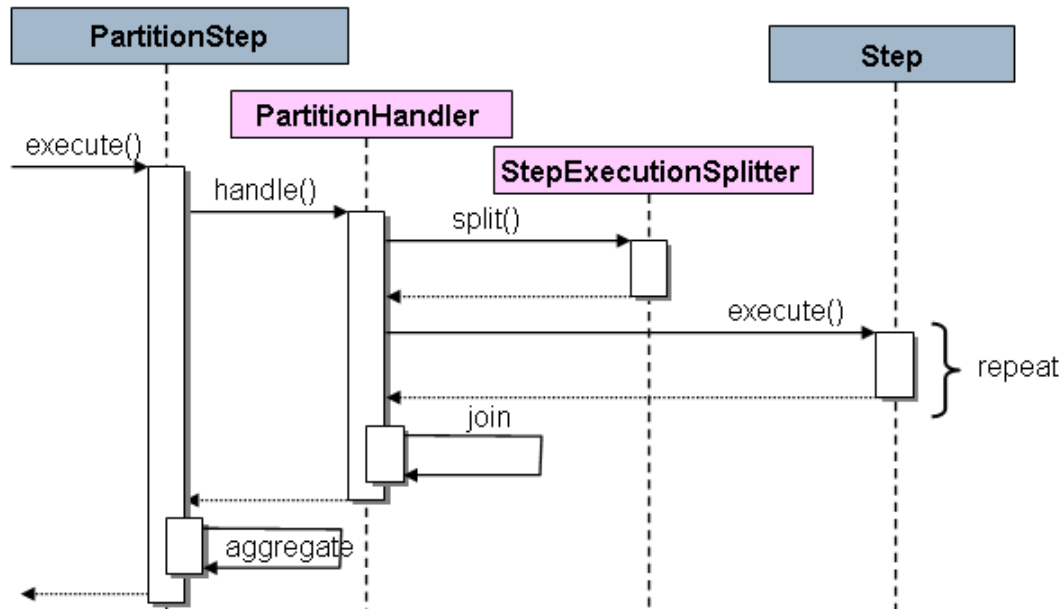

The Step on the right in this case is the "remote" Slave, so potentially there are many objects and processes playing this role, and the PartitionStep is shown driving the execution. The PartitionStep configuration looks like this:

```

<step id="step1.master">
  <partition step="step1" partitioner="partitioner">
    <handler grid-size="10" task-executor="taskExecutor"/>
  </partition>
</step>

```

Similar to the multi-threaded step's throttle-limit attribute, the grid-size attribute prevents the task executor from being saturated with requests from a single step.

There is a simple example which can be copied and extended in the unit test suite for Spring Batch Samples (see `*PartitionJob.xml` configuration).

Spring Batch creates step executions for the partitions called "step1:partition0", etc., so many people prefer to call the master step "step1:master" for consistency. With Spring 3.0 you can do this using an alias for the step (specifying the `name` attribute instead of the `id`).

PartitionHandler

The `PartitionHandler` is the component that knows about the fabric of the remoting or grid environment. It is able to send `StepExecution` requests to the remote Steps, wrapped in some fabric-specific format, like a DTO. It does not have to know how to split up the input data, or how to aggregate the result of multiple Step executions. Generally speaking it probably also doesn't need to know about resilience or failover, since those are features of the fabric in many cases, and anyway Spring Batch

always provides restartability independent of the fabric: a failed Job can always be restarted and only the failed Steps will be re-executed.

The `PartitionHandler` interface can have specialized implementations for a variety of fabric types: e.g. simple RMI remoting, EJB remoting, custom web service, JMS, Java Spaces, shared memory grids (like Terracotta or Coherence), grid execution fabrics (like GridGain). Spring Batch does not contain implementations for any proprietary grid or remoting fabrics.

Spring Batch does however provide a useful implementation of `PartitionHandler` that executes Steps locally in separate threads of execution, using the `TaskExecutor` strategy from Spring. The implementation is called `TaskExecutorPartitionHandler`, and it is the default for a step configured with the XML namespace as above. It can also be configured explicitly like this:

```
<step id="step1.master">
  <partition step="step1" handler="handler"/>
</step>

<bean class="org.spr...TaskExecutorPartitionHandler">
  <property name="taskExecutor" ref="taskExecutor"/>
  <property name="step" ref="step1" />
  <property name="gridSize" value="10" />
</bean>
```

The `gridSize` determines the number of separate step executions to create, so it can be matched to the size of the thread pool in the `TaskExecutor`, or else it can be set to be larger than the number of threads available, in which case the blocks of work are smaller.

The `TaskExecutorPartitionHandler` is quite useful for IO intensive Steps, like copying large numbers of files or replicating filesystems into content management systems. It can also be used for remote execution by providing a Step implementation that is a proxy for a remote invocation (e.g. using Spring Remoting).

Partitioner

The `Partitioner` has a simpler responsibility: to generate execution contexts as input parameters for new step executions only (no need to worry about restarts). It has a single method:

```
public interface Partitioner {
    Map<String, ExecutionContext> partition(int gridSize);
}
```

The return value from this method associates a unique name for each step execution (the `String`), with input parameters in the form of an `ExecutionContext`. The names show up later in the Batch meta data as the step name in the partitioned `StepExecutions`. The `ExecutionContext` is just a bag of name-value pairs, so it might contain a range of primary keys, or line numbers, or the location of an input file. The remote Step then normally binds to the context input using `#{ . . . }` placeholders (late binding in step scope), as illustrated in the next section.

The names of the step executions (the keys in the `Map` returned by `Partitioner`) need to be unique amongst the step executions of a Job, but do not have any other specific requirements. The easiest way to do this, and to make the names meaningful for users, is to use a prefix+suffix naming convention, where the prefix is the name of the step that is being executed (which itself is unique in the Job), and the suffix is just a counter. There is a `SimplePartitioner` in the framework that uses this convention.

An optional interface `PartitionerNameProvider` can be used to provide the partition names separately from the partitions themselves. If a `Partitioner` implements this interface then on a restart

only the names will be queried. If partitioning is expensive this can be a useful optimisation. Obviously the names provided by the `PartitionNameProvider` must match those provided by the `Partitioner`.

Binding Input Data to Steps

It is very efficient for the steps that are executed by the `PartitionHandler` to have identical configuration, and for their input parameters to be bound at runtime from the `ExecutionContext`. This is easy to do with the `StepScope` feature of Spring Batch (covered in more detail in the section on Late Binding). For example if the `Partitioner` creates `ExecutionContext` instances with an attribute key `fileName`, pointing to a different file (or directory) for each step invocation, the `Partitioner` output might look like this:

Table 7.1. Example step execution name to execution context provided by `Partitioner` targeting directory processing

Step Execution Name (key)	ExecutionContext (value)
filecopy:partition0	fileName=/home/data/one
filecopy:partition1	fileName=/home/data/two
filecopy:partition2	fileName=/home/data/three

Then the file name can be bound to a step using late binding to the execution context:

```
<bean id="itemReader" scope="step"
      class="org.spr...MultiResourceItemReader">
  <property name="resource" value="#{stepExecutionContext[fileName]}/*" />
</bean>
```

8. Repeat

8.1 RepeatTemplate

Batch processing is about repetitive actions - either as a simple optimization, or as part of a job. To strategize and generalize the repetition as well as to provide what amounts to an iterator framework, Spring Batch has the `RepeatOperations` interface. The `RepeatOperations` interface looks like this:

```
public interface RepeatOperations {

    RepeatStatus iterate(RepeatCallback callback) throws RepeatException;

}
```

The callback is a simple interface that allows you to insert some business logic to be repeated:

```
public interface RepeatCallback {

    RepeatStatus doInIteration(RepeatContext context) throws Exception;

}
```

The callback is executed repeatedly until the implementation decides that the iteration should end. The return value in these interfaces is an enumeration that can either be `RepeatStatus.CONTINUABLE` or `RepeatStatus.FINISHED`. A `RepeatStatus` conveys information to the caller of the repeat operations about whether there is any more work to do. Generally speaking, implementations of `RepeatOperations` should inspect the `RepeatStatus` and use it as part of the decision to end the iteration. Any callback that wishes to signal to the caller that there is no more work to do can return `RepeatStatus.FINISHED`.

The simplest general purpose implementation of `RepeatOperations` is `RepeatTemplate`. It could be used like this:

```
RepeatTemplate template = new RepeatTemplate();

template.setCompletionPolicy(new FixedChunkSizeCompletionPolicy(2));

template.iterate(new RepeatCallback() {

    public ExitStatus doInIteration(RepeatContext context) {
        // Do stuff in batch...
        return ExitStatus.CONTINUABLE;
    }

});
```

In the example we return `RepeatStatus.CONTINUABLE` to show that there is more work to do. The callback can also return `ExitStatus.FINISHED` if it wants to signal to the caller that there is no more work to do. Some iterations can be terminated by considerations intrinsic to the work being done in the callback, others are effectively infinite loops as far as the callback is concerned and the completion decision is delegated to an external policy as in the case above.

RepeatContext

The method parameter for the `RepeatCallback` is a `RepeatContext`. Many callbacks will simply ignore the context, but if necessary it can be used as an attribute bag to store transient data for the duration of the iteration. After the `iterate` method returns, the context will no longer exist.

A `RepeatContext` will have a parent context if there is a nested iteration in progress. The parent context is occasionally useful for storing data that need to be shared between calls to `iterate`. This is the case for instance if you want to count the number of occurrences of an event in the iteration and remember it across subsequent calls.

RepeatStatus

`RepeatStatus` is an enumeration used by Spring Batch to indicate whether processing has finished. These are possible `RepeatStatus` values:

Table 8.1. *ExitStatus Properties*

Value	Description
CONTINUABLE	There is more work to do.
FINISHED	No more repetitions should take place.

`RepeatStatus` values can also be combined with a logical AND operation using the `and()` method in `RepeatStatus`. The effect of this is to do a logical AND on the continuable flag. In other words, if either status is `FINISHED`, then the result will be `FINISHED`.

8.2 Completion Policies

Inside a `RepeatTemplate` the termination of the loop in the `iterate` method is determined by a `CompletionPolicy` which is also a factory for the `RepeatContext`. The `RepeatTemplate` has the responsibility to use the current policy to create a `RepeatContext` and pass that in to the `RepeatCallback` at every stage in the iteration. After a callback completes its `doInIteration`, the `RepeatTemplate` has to make a call to the `CompletionPolicy` to ask it to update its state (which will be stored in the `RepeatContext`). Then it asks the policy if the iteration is complete.

Spring Batch provides some simple general purpose implementations of `CompletionPolicy`. The `SimpleCompletionPolicy` just allows an execution up to a fixed number of times (with `RepeatStatus.FINISHED` forcing early completion at any time).

Users might need to implement their own completion policies for more complicated decisions. For example, a batch processing window that prevents batch jobs from executing once the online systems are in use would require a custom policy.

8.3 Exception Handling

If there is an exception thrown inside a `RepeatCallback`, the `RepeatTemplate` consults an `ExceptionHandler` which can decide whether or not to re-throw the exception.

```
public interface ExceptionHandler {
    void handleException(RepeatContext context, Throwable throwable)
        throws RuntimeException;
}
```

A common use case is to count the number of exceptions of a given type, and fail when a limit is reached. For this purpose Spring Batch provides the `SimpleLimitExceptionHandler` and slightly

more flexible `RethrowOnThresholdExceptionHandler`. The `SimpleLimitExceptionHandler` has a `limit` property and an exception type that should be compared with the current exception - all subclasses of the provided type are also counted. Exceptions of the given type are ignored until the limit is reached, and then rethrown. Those of other types are always rethrown.

An important optional property of the `SimpleLimitExceptionHandler` is the boolean flag `useParent`. It is `false` by default, so the limit is only accounted for in the current `RepeatContext`. When set to `true`, the limit is kept across sibling contexts in a nested iteration (e.g. a set of chunks inside a step).

8.4 Listeners

Often it is useful to be able to receive additional callbacks for cross cutting concerns across a number of different iterations. For this purpose Spring Batch provides the `RepeatListener` interface. The `RepeatTemplate` allows users to register `RepeatListeners`, and they will be given callbacks with the `RepeatContext` and `RepeatStatus` where available during the iteration.

The interface looks like this:

```
public interface RepeatListener {
    void before(RepeatContext context);
    void after(RepeatContext context, RepeatStatus result);
    void open(RepeatContext context);
    void onError(RepeatContext context, Throwable e);
    void close(RepeatContext context);
}
```

The `open` and `close` callbacks come before and after the entire iteration. `before`, `after` and `onError` apply to the individual `RepeatCallback` calls.

Note that when there is more than one listener, they are in a list, so there is an order. In this case `open` and `before` are called in the same order while `after`, `onError` and `close` are called in reverse order.

8.5 Parallel Processing

Implementations of `RepeatOperations` are not restricted to executing the callback sequentially. It is quite important that some implementations are able to execute their callbacks in parallel. To this end, Spring Batch provides the `TaskExecutorRepeatTemplate`, which uses the Spring `TaskExecutor` strategy to run the `RepeatCallback`. The default is to use a `SynchronousTaskExecutor`, which has the effect of executing the whole iteration in the same thread (the same as a normal `RepeatTemplate`).

8.6 Declarative Iteration

Sometimes there is some business processing that you know you want to repeat every time it happens. The classic example of this is the optimization of a message pipeline - it is more efficient to process a batch of messages, if they are arriving frequently, than to bear the cost of a separate transaction for every message. Spring Batch provides an AOP interceptor that wraps a method call in a `RepeatOperations` for just this purpose. The `RepeatOperationsInterceptor` executes the intercepted method and repeats according to the `CompletionPolicy` in the provided `RepeatTemplate`.

Here is an example of declarative iteration using the Spring AOP namespace to repeat a service call to a method called `processMessage` (for more detail on how to configure AOP interceptors see the Spring User Guide):

```
<aop:config>
  <aop:pointcut id="transactional"
    expression="execution(* com.*Service.processMessage(..)" />
  <aop:advisor pointcut-ref="transactional"
    advice-ref="retryAdvice" order="-1"/>
</aop:config>

<bean id="retryAdvice" class="org.spr...RepeatOperationsInterceptor"/>
```

The example above uses a default `RepeatTemplate` inside the interceptor. To change the policies, listeners etc. you only need to inject an instance of `RepeatTemplate` into the interceptor.

If the intercepted method returns `void` then the interceptor always returns `ExitStatus.CONTINUABLE` (so there is a danger of an infinite loop if the `CompletionPolicy` does not have a finite end point). Otherwise it returns `ExitStatus.CONTINUABLE` until the return value from the intercepted method is null, at which point it returns `ExitStatus.FINISHED`. So the business logic inside the target method can signal that there is no more work to do by returning `null`, or by throwing an exception that is re-thrown by the `ExceptionHandler` in the provided `RepeatTemplate`.

9. Retry

9.1 RetryTemplate

Note

The retry functionality was pulled out of Spring Batch as of 2.2.0. It is now part of a new library, Spring Retry.

To make processing more robust and less prone to failure, sometimes it helps to automatically retry a failed operation in case it might succeed on a subsequent attempt. Errors that are susceptible to this kind of treatment are transient in nature. For example a remote call to a web service or RMI service that fails because of a network glitch or a `DeadLockLoserException` in a database update may resolve themselves after a short wait. To automate the retry of such operations Spring Batch has the `RetryOperations` strategy. The `RetryOperations` interface looks like this:

```
public interface RetryOperations {

    <T> T execute(RetryCallback<T> retryCallback) throws Exception;

    <T> T execute(RetryCallback<T> retryCallback, RecoveryCallback<T> recoveryCallback)
        throws Exception;

    <T> T execute(RetryCallback<T> retryCallback, RetryState retryState)
        throws Exception, ExhaustedRetryException;

    <T> T execute(RetryCallback<T> retryCallback, RecoveryCallback<T> recoveryCallback,
        RetryState retryState) throws Exception;

}
```

The basic callback is a simple interface that allows you to insert some business logic to be retried:

```
public interface RetryCallback<T> {

    T doWithRetry(RetryContext context) throws Throwable;

}
```

The callback is executed and if it fails (by throwing an `Exception`), it will be retried until either it is successful, or the implementation decides to abort. There are a number of overloaded `execute` methods in the `RetryOperations` interface dealing with various use cases for recovery when all retry attempts are exhausted, and also with retry state, which allows clients and implementations to store information between calls (more on this later).

The simplest general purpose implementation of `RetryOperations` is `RetryTemplate`. It could be used like this

```

RetryTemplate template = new RetryTemplate();

TimeoutRetryPolicy policy = new TimeoutRetryPolicy();
policy.setTimeout(30000L);

template.setRetryPolicy(policy);

Foo result = template.execute(new RetryCallback<Foo>() {

    public Foo doWithRetry(RetryContext context) {
        // Do stuff that might fail, e.g. webservice operation
        return result;
    }

});

```

In the example we execute a web service call and return the result to the user. If that call fails then it is retried until a timeout is reached.

RetryContext

The method parameter for the `RetryCallback` is a `RetryContext`. Many callbacks will simply ignore the context, but if necessary it can be used as an attribute bag to store data for the duration of the iteration.

A `RetryContext` will have a parent context if there is a nested retry in progress in the same thread. The parent context is occasionally useful for storing data that need to be shared between calls to `execute`.

RecoveryCallback

When a retry is exhausted the `RetryOperations` can pass control to a different callback, the `RecoveryCallback`. To use this feature clients just pass in the callbacks together to the same method, for example:

```

Foo foo = template.execute(new RetryCallback<Foo>() {
    public Foo doWithRetry(RetryContext context) {
        // business logic here
    },
    new RecoveryCallback<Foo>() {
        Foo recover(RetryContext context) throws Exception {
            // recover logic here
        }
    }
});

```

If the business logic does not succeed before the template decides to abort, then the client is given the chance to do some alternate processing through the recovery callback.

Stateless Retry

In the simplest case, a retry is just a while loop: the `RetryTemplate` can just keep trying until it either succeeds or fails. The `RetryContext` contains some state to determine whether to retry or abort, but this state is on the stack and there is no need to store it anywhere globally, so we call this stateless retry. The distinction between stateless and stateful retry is contained in the implementation of the `RetryPolicy` (the `RetryTemplate` can handle both). In a stateless retry, the callback is always executed in the same thread on retry as when it failed.

Stateful Retry

Where the failure has caused a transactional resource to become invalid, there are some special considerations. This does not apply to a simple remote call because there is no transactional resource

(usually), but it does sometimes apply to a database update, especially when using Hibernate. In this case it only makes sense to rethrow the exception that called the failure immediately so that the transaction can roll back and we can start a new valid one.

In these cases a stateless retry is not good enough because the re-throw and roll back necessarily involve leaving the `RetryOperations.execute()` method and potentially losing the context that was on the stack. To avoid losing it we have to introduce a storage strategy to lift it off the stack and put it (at a minimum) in heap storage. For this purpose Spring Batch provides a storage strategy `RetryContextCache` which can be injected into the `RetryTemplate`. The default implementation of the `RetryContextCache` is in memory, using a simple `Map`. Advanced usage with multiple processes in a clustered environment might also consider implementing the `RetryContextCache` with a cluster cache of some sort (though, even in a clustered environment this might be overkill).

Part of the responsibility of the `RetryOperations` is to recognize the failed operations when they come back in a new execution (and usually wrapped in a new transaction). To facilitate this, Spring Batch provides the `RetryState` abstraction. This works in conjunction with a special `execute` methods in the `RetryOperations`.

The way the failed operations are recognized is by identifying the state across multiple invocations of the retry. To identify the state, the user can provide an `RetryState` object that is responsible for returning a unique key identifying the item. The identifier is used as a key in the `RetryContextCache`.

Warning

Be very careful with the implementation of `Object.equals()` and `Object.hashCode()` in the key returned by `RetryState`. The best advice is to use a business key to identify the items. In the case of a JMS message the message ID can be used.

When the retry is exhausted there is also the option to handle the failed item in a different way, instead of calling the `RetryCallback` (which is presumed now to be likely to fail). Just like in the stateless case, this option is provided by the `RecoveryCallback`, which can be provided by passing it in to the `execute` method of `RetryOperations`.

The decision to retry or not is actually delegated to a regular `RetryPolicy`, so the usual concerns about limits and timeouts can be injected there (see below).

9.2 Retry Policies

Inside a `RetryTemplate` the decision to retry or fail in the `execute` method is determined by a `RetryPolicy` which is also a factory for the `RetryContext`. The `RetryTemplate` has the responsibility to use the current policy to create a `RetryContext` and pass that in to the `RetryCallback` at every attempt. After a callback fails the `RetryTemplate` has to make a call to the `RetryPolicy` to ask it to update its state (which will be stored in the `RetryContext`), and then it asks the policy if another attempt can be made. If another attempt cannot be made (e.g. a limit is reached or a timeout is detected) then the policy is also responsible for handling the exhausted state. Simple implementations will just throw `RetryExhaustedException` which will cause any enclosing transaction to be rolled back. More sophisticated implementations might attempt to take some recovery action, in which case the transaction can remain intact.

Tip

Failures are inherently either retryable or not - if the same exception is always going to be thrown from the business logic, it doesn't help to retry it. So don't retry on all exception types - try to focus on only those exceptions that you expect to be retryable. It's not usually harmful to the business logic to retry more aggressively, but it's wasteful because if a failure is deterministic there will be time spent retrying something that you know in advance is fatal.

Spring Batch provides some simple general purpose implementations of stateless `RetryPolicy`, for example a `SimpleRetryPolicy`, and the `TimeoutRetryPolicy` used in the example above.

The `SimpleRetryPolicy` just allows a retry on any of a named list of exception types, up to a fixed number of times. It also has a list of "fatal" exceptions that should never be retried, and this list overrides the retryable list so that it can be used to give finer control over the retry behavior:

```
SimpleRetryPolicy policy = new SimpleRetryPolicy();
// Set the max retry attempts
policy.setMaxAttempts(5);
// Retry on all exceptions (this is the default)
policy.setRetryableExceptions(new Class[] {Exception.class});
// ... but never retry IllegalStateException
policy.setFatalExceptions(new Class[] {IllegalStateException.class});

// Use the policy...
RetryTemplate template = new RetryTemplate();
template.setRetryPolicy(policy);
template.execute(new RetryCallback<Foo>() {
    public Foo doWithRetry(RetryContext context) {
        // business logic here
    }
});
```

There is also a more flexible implementation called `ExceptionClassifierRetryPolicy`, which allows the user to configure different retry behavior for an arbitrary set of exception types through the `ExceptionClassifier` abstraction. The policy works by calling on the classifier to convert an exception into a delegate `RetryPolicy`, so for example, one exception type can be retried more times before failure than another by mapping it to a different policy.

Users might need to implement their own retry policies for more customized decisions. For instance, if there is a well-known, solution-specific, classification of exceptions into retryable and not retryable.

9.3 Backoff Policies

When retrying after a transient failure it often helps to wait a bit before trying again, because usually the failure is caused by some problem that will only be resolved by waiting. If a `RetryCallback` fails, the `RetryTemplate` can pause execution according to the `BackoffPolicy` in place.

```
public interface BackoffPolicy {

    BackOffContext start(RetryContext context);

    void backOff(BackOffContext backOffContext)
        throws BackOffInterruptedException;

}
```

A `BackoffPolicy` is free to implement the `backOff` in any way it chooses. The policies provided by Spring Batch out of the box all use `Object.wait()`. A common use case is to backoff with an exponentially increasing wait period, to avoid two retries getting into lock step and both

failing - this is a lesson learned from the ethernet. For this purpose Spring Batch provides the `ExponentialBackoffPolicy`.

9.4 Listeners

Often it is useful to be able to receive additional callbacks for cross cutting concerns across a number of different retries. For this purpose Spring Batch provides the `RetryListener` interface. The `RetryTemplate` allows users to register `RetryListeners`, and they will be given callbacks with the `RetryContext` and `Throwable` where available during the iteration.

The interface looks like this:

```
public interface RetryListener {  
  
    void open(RetryContext context, RetryCallback<T> callback);  
  
    void onError(RetryContext context, RetryCallback<T> callback, Throwable e);  
  
    void close(RetryContext context, RetryCallback<T> callback, Throwable e);  
  
}
```

The `open` and `close` callbacks come before and after the entire retry in the simplest case and `onError` applies to the individual `RetryCallback` calls. The `close` method might also receive a `Throwable`; if there has been an error it is the last one thrown by the `RetryCallback`.

Note that when there is more than one listener, they are in a list, so there is an order. In this case `open` will be called in the same order while `onError` and `close` will be called in reverse order.

9.5 Declarative Retry

Sometimes there is some business processing that you know you want to retry every time it happens. The classic example of this is the remote service call. Spring Batch provides an AOP interceptor that wraps a method call in a `RetryOperations` for just this purpose. The `RetryOperationsInterceptor` executes the intercepted method and retries on failure according to the `RetryPolicy` in the provided `RepeatTemplate`.

Here is an example of declarative iteration using the Spring AOP namespace to repeat a service call to a method called `remoteCall` (for more detail on how to configure AOP interceptors see the Spring User Guide):

```
<aop:config>  
  <aop:pointcut id="transactional"  
    expression="execution(* com.*Service.remoteCall(..)" />  
  <aop:advisor pointcut-ref="transactional"  
    advice-ref="retryAdvice" order="-1"/>  
</aop:config>  
  
<bean id="retryAdvice"  
  class="org.springframework.batch.retry.interceptor.RetryOperationsInterceptor"/>
```

The example above uses a default `RetryTemplate` inside the interceptor. To change the policies or listeners, you only need to inject an instance of `RetryTemplate` into the interceptor.

10. Unit Testing

Just as with other application styles, it is extremely important to unit test any code written as part of a batch job as well. The Spring core documentation covers how to unit and integration test with Spring in great detail, so it won't be repeated here. It is important, however, to think about how to 'end to end' test a batch job, which is what this chapter will focus on. The `spring-batch-test` project includes classes that will help facilitate this end-to-end test approach.

10.1 Creating a Unit Test Class

In order for the unit test to run a batch job, the framework must load the job's `ApplicationContext`. Two annotations are used to trigger this:

- `@RunWith(SpringJUnit4ClassRunner.class)`: Indicates that the class should use Spring's JUnit facilities
- `@ContextConfiguration(locations = {...})`: Indicates which XML files contain the `ApplicationContext`.

```
@RunWith(SpringJUnit4ClassRunner.class)
@ContextConfiguration(locations = { "/simple-job-launcher-context.xml",
                                   "/jobs/skipSampleJob.xml" })
public class SkipSampleFunctionalTests { ... }
```

10.2 End-To-End Testing of Batch Jobs

'End To End' testing can be defined as testing the complete run of a batch job from beginning to end. This allows for a test that sets up a test condition, executes the job, and verifies the end result.

In the example below, the batch job reads from the database and writes to a flat file. The test method begins by setting up the database with test data. It clears the `CUSTOMER` table and then inserts 10 new records. The test then launches the `Job` using the `launchJob()` method. The `launchJob()` method is provided by the `JobLauncherTestUtils` class. Also provided by the `utils` class is `launchJob(JobParameters)`, which allows the test to give particular parameters. The `launchJob()` method returns the `JobExecution` object which is useful for asserting particular information about the `Job` run. In the case below, the test verifies that the `Job` ended with status "COMPLETED".

```

@RunWith(SpringJUnit4ClassRunner.class)
@ContextConfiguration(locations = { "/simple-job-launcher-context.xml",
                                   "/jobs/skipSampleJob.xml" })
public class SkipSampleFunctionalTests {

    @Autowired
    private JobLauncherTestUtils jobLauncherTestUtils;

    private SimpleJdbcTemplate simpleJdbcTemplate;

    @Autowired
    public void setDataSource(DataSource dataSource) {
        this.simpleJdbcTemplate = new SimpleJdbcTemplate(dataSource);
    }

    @Test
    public void testJob() throws Exception {
        simpleJdbcTemplate.update("delete from CUSTOMER");
        for (int i = 1; i <= 10; i++) {
            simpleJdbcTemplate.update("insert into CUSTOMER values (?, 0, ?, 100000)",
                                     i, "customer" + i);
        }

        JobExecution jobExecution = jobLauncherTestUtils.launchJob().getStatus();

        Assert.assertEquals("COMPLETED", jobExecution.getExitStatus());
    }
}

```

10.3 Testing Individual Steps

For complex batch jobs, test cases in the end-to-end testing approach may become unmanageable. In these cases, it may be more useful to have test cases to test individual steps on their own. The `AbstractJobTests` class contains a method `launchStep` that takes a step name and runs just that particular `Step`. This approach allows for more targeted tests by allowing the test to set up data for just that step and to validate its results directly.

```
JobExecution jobExecution = jobLauncherTestUtils.launchStep("loadFileStep");
```

10.4 Testing Step-Scoped Components

Often the components that are configured for your steps at runtime use step scope and late binding to inject context from the step or job execution. These are tricky to test as standalone components unless you have a way to set the context as if they were in a step execution. That is the goal of two components in Spring Batch: the `StepScopeTestExecutionListener` and the `StepScopeTestUtils`.

The listener is declared at the class level, and its job is to create a step execution context for each test method. For example:

```

@ContextConfiguration
@TestExecutionListeners( { DependencyInjectionTestExecutionListener.class,
    StepScopeTestExecutionListener.class } )
@RunWith(SpringJUnit4ClassRunner.class)
public class StepScopeTestExecutionListenerIntegrationTests {

    // This component is defined step-scoped, so it cannot be injected unless
    // a step is active...
    @Autowired
    private ItemReader<String> reader;

    public StepExecution getStepExecution() {
        StepExecution execution = MetaDataInstanceFactory.createStepExecution();
        execution.getExecutionContext().putString("input.data", "foo,bar,spam");
        return execution;
    }

    @Test
    public void testReader() {
        // The reader is initialized and bound to the input data
        assertNotNull(reader.read());
    }
}

```

There are two `TestExecutionListeners`, one from the regular Spring Test framework and handles dependency injection from the configured application context, injecting the reader, and the other is the Spring Batch `StepScopeTestExecutionListener`. It works by looking for a factory method in the test case for a `StepExecution`, and using that as the context for the test method, as if that execution was active in a Step at runtime. The factory method is detected by its signature (it just has to return a `StepExecution`). If a factory method is not provided then a default `StepExecution` is created.

The listener approach is convenient if you want the duration of the step scope to be the execution of the test method. For a more flexible, but more invasive approach you can use the `StepScopeTestUtils`. For example, to count the number of items available in the reader above:

```

int count = StepScopeTestUtils.doInStepScope(stepExecution,
    new Callable<Integer>() {
        public Integer call() throws Exception {

            int count = 0;

            while (reader.read() != null) {
                count++;
            }
            return count;
        }
    });

```

10.5 Validating Output Files

When a batch job writes to the database, it is easy to query the database to verify that the output is as expected. However, if the batch job writes to a file, it is equally important that the output be verified. Spring Batch provides a class `AssertFile` to facilitate the verification of output files. The method `assertFileEquals` takes two `File` objects (or two `Resource` objects) and asserts, line by line, that the two files have the same content. Therefore, it is possible to create a file with the expected output and to compare it to the actual result:

```
private static final String EXPECTED_FILE = "src/main/resources/data/input.txt";
private static final String OUTPUT_FILE = "target/test-outputs/output.txt";

AssertFile.assertFileEquals(new FileSystemResource(EXPECTED_FILE),
    new FileSystemResource(OUTPUT_FILE));
```

10.6 Mocking Domain Objects

Another common issue encountered while writing unit and integration tests for Spring Batch components is how to mock domain objects. A good example is a `StepExecutionListener`, as illustrated below:

```
public class NoWorkFoundStepExecutionListener extends StepExecutionListenerSupport {

    public ExitStatus afterStep(StepExecution stepExecution) {
        if (stepExecution.getReadCount() == 0) {
            throw new NoWorkFoundException("Step has not processed any items");
        }
        return stepExecution.getExitStatus();
    }
}
```

The above listener is provided by the framework and checks a `StepExecution` for an empty read count, thus signifying that no work was done. While this example is fairly simple, it serves to illustrate the types of problems that may be encountered when attempting to unit test classes that implement interfaces requiring Spring Batch domain objects. Consider the above listener's unit test:

```
private NoWorkFoundStepExecutionListener tested = new NoWorkFoundStepExecutionListener();

@Test
public void testAfterStep() {
    StepExecution stepExecution = new StepExecution("NoProcessingStep",
        new JobExecution(new JobInstance(1L, new JobParameters(),
            "NoProcessingJob")));

    stepExecution.setReadCount(0);

    try {
        tested.afterStep(stepExecution);
        fail();
    } catch (NoWorkFoundException e) {
        assertEquals("Step has not processed any items", e.getMessage());
    }
}
```

Because the Spring Batch domain model follows good object orientated principles, the `StepExecution` requires a `JobExecution`, which requires a `JobInstance` and `JobParameters` in order to create a valid `StepExecution`. While this is good in a solid domain model, it does make creating stub objects for unit testing verbose. To address this issue, the Spring Batch test module includes a factory for creating domain objects: `MetaDataInstanceFactory`. Given this factory, the unit test can be updated to be more concise:

```
private NoWorkFoundStepExecutionListener tested = new NoWorkFoundStepExecutionListener();

@Test
public void testAfterStep() {
    StepExecution stepExecution = MetadataInstanceFactory.createStepExecution();

    stepExecution.setReadCount(0);

    try {
        tested.afterStep(stepExecution);
        fail();
    } catch (NoWorkFoundException e) {
        assertEquals("Step has not processed any items", e.getMessage());
    }
}
```

The above method for creating a simple `StepExecution` is just one convenience method available within the factory. A full method listing can be found in its [Javadoc](#).

11. Common Batch Patterns

Some batch jobs can be assembled purely from off-the-shelf components in Spring Batch. For instance the `ItemReader` and `ItemWriter` implementations can be configured to cover a wide range of scenarios. However, for the majority of cases, custom code will have to be written. The main API entry points for application developers are the `Tasklet`, `ItemReader`, `ItemWriter` and the various listener interfaces. Most simple batch jobs will be able to use off-the-shelf input from a Spring Batch `ItemReader`, but it is often the case that there are custom concerns in the processing and writing, which require developers to implement an `ItemWriter` or `ItemProcessor`.

Here, we provide a few examples of common patterns in custom business logic. These examples primarily feature the listener interfaces. It should be noted that an `ItemReader` or `ItemWriter` can implement a listener interface as well, if appropriate.

11.1 Logging Item Processing and Failures

A common use case is the need for special handling of errors in a step, item by item, perhaps logging to a special channel, or inserting a record into a database. A chunk-oriented `Step` (created from the step factory beans) allows users to implement this use case with a simple `ItemReadListener`, for errors on read, and an `ItemWriteListener`, for errors on write. The below code snippets illustrate a listener that logs both read and write failures:

```
public class ItemFailureLoggerListener extends ItemListenerSupport {

    private static Log logger = LogFactory.getLog("item.error");

    public void onReadError(Exception ex) {
        logger.error("Encountered error on read", e);
    }

    public void onWriteError(Exception ex, Object item) {
        logger.error("Encountered error on write", ex);
    }

}
```

Having implemented this listener it must be registered with the step:

```
<step id="simpleStep">
  ...
  <listeners>
    <listener>
      <bean class="org.example...ItemFailureLoggerListener"/>
    </listener>
  </listeners>
</step>
```

Remember that if your listener does anything in an `onError()` method, it will be inside a transaction that is going to be rolled back. If you need to use a transactional resource such as a database inside an `onError()` method, consider adding a declarative transaction to that method (see Spring Core Reference Guide for details), and giving its propagation attribute the value `REQUIRES_NEW`.

11.2 Stopping a Job Manually for Business Reasons

Spring Batch provides a `stop()` method through the `JobLauncher` interface, but this is really for use by the operator rather than the application programmer. Sometimes it is more convenient or makes more sense to stop a job execution from within the business logic.

The simplest thing to do is to throw a `RuntimeException` (one that isn't retried indefinitely or skipped). For example, a custom exception type could be used, as in the example below:

```
public class PoisonPillItemWriter implements ItemWriter<T> {

    public void write(T item) throws Exception {
        if (isPoisonPill(item)) {
            throw new PoisonPillException("Posion pill detected: " + item);
        }
    }

}
```

Another simple way to stop a step from executing is to simply return null from the `ItemReader`:

```
public class EarlyCompletionItemReader implements ItemReader<T> {

    private ItemReader<T> delegate;

    public void setDelegate(ItemReader<T> delegate) { ... }

    public T read() throws Exception {
        T item = delegate.read();
        if (isEndItem(item)) {
            return null; // end the step here
        }
        return item;
    }

}
```

The previous example actually relies on the fact that there is a default implementation of the `CompletionPolicy` strategy which signals a complete batch when the item to be processed is null. A more sophisticated completion policy could be implemented and injected into the `Step` through the `SimpleStepFactoryBean`:

```
<step id="simpleStep">
  <tasklet>
    <chunk reader="reader" writer="writer" commit-interval="10"
      chunk-completion-policy="completionPolicy"/>
  </tasklet>
</step>

<bean id="completionPolicy" class="org.example...SpecialCompletionPolicy"/>
```

An alternative is to set a flag in the `StepExecution`, which is checked by the `Step` implementations in the framework in between item processing. To implement this alternative, we need access to the current `StepExecution`, and this can be achieved by implementing a `StepListener` and registering it with the `Step`. Here is an example of a listener that sets the flag:

```
public class CustomItemWriter extends ItemListenerSupport implements StepListener {

    private StepExecution stepExecution;

    public void beforeStep(StepExecution stepExecution) {
        this.stepExecution = stepExecution;
    }

    public void afterRead(Object item) {
        if (isPoisonPill(item)) {
            stepExecution.setTerminateOnly(true);
        }
    }

}
```

The default behavior here when the flag is set is for the step to throw a `JobInterruptedException`. This can be controlled through the `StepInterruptionPolicy`, but the only choice is to throw or not throw an exception, so this is always an abnormal ending to a job.

11.3 Adding a Footer Record

Often when writing to flat files, a "footer" record must be appended to the end of the file, after all processing has been completed. This can also be achieved using the `FlatFileFooterCallback` interface provided by Spring Batch. The `FlatFileFooterCallback` (and its counterpart, the `FlatFileHeaderCallback`) are optional properties of the `FlatFileItemWriter`:

```
<bean id="itemWriter" class="org.spr...FlatFileItemWriter">
  <property name="resource" ref="outputResource" />
  <property name="lineAggregator" ref="lineAggregator"/>
  <property name="headerCallback" ref="headerCallback" />
  <property name="footerCallback" ref="footerCallback" />
</bean>
```

The footer callback interface is very simple. It has just one method that is called when the footer must be written:

```
public interface FlatFileFooterCallback {

    void writeFooter(Writer writer) throws IOException;

}
```

Writing a Summary Footer

A very common requirement involving footer records is to aggregate information during the output process and to append this information to the end of the file. This footer serves as a summarization of the file or provides a checksum.

For example, if a batch job is writing `Trade` records to a flat file, and there is a requirement that the total amount from all the `Trades` is placed in a footer, then the following `ItemWriter` implementation can be used:

```
public class TradeItemWriter implements ItemWriter<Trade>,
                                       FlatFileFooterCallback {

    private ItemWriter<Trade> delegate;

    private BigDecimal totalAmount = BigDecimal.ZERO;

    public void write(List<? extends Trade> items) {
        BigDecimal chunkTotal = BigDecimal.ZERO;
        for (Trade trade : items) {
            chunkTotal = chunkTotal.add(trade.getAmount());
        }

        delegate.write(items);

        // After successfully writing all items
        totalAmount = totalAmount.add(chunkTotal);
    }

    public void writeFooter(Writer writer) throws IOException {
        writer.write("Total Amount Processed: " + totalAmount);
    }

    public void setDelegate(ItemWriter delegate) {...}
}
```

This `TradeItemWriter` stores a `totalAmount` value that is increased with the amount from each `Trade` item written. After the last `Trade` is processed, the framework will call `writeFooter`, which will put that `totalAmount` into the file. Note that the `write` method makes use of a temporary variable, `chunkTotalAmount`, that stores the total of the trades in the chunk. This is done to ensure that if a skip occurs in the `write` method, that the `totalAmount` will be left unchanged. It is only at the end of the `write` method, once we are guaranteed that no exceptions will be thrown, that we update the `totalAmount`.

In order for the `writeFooter` method to be called, the `TradeItemWriter` (which implements `FlatFileFooterCallback`) must be wired into the `FlatFileItemWriter` as the `footerCallback`:

```
<bean id="tradeItemWriter" class="..TradeItemWriter">
  <property name="delegate" ref="flatFileItemWriter" />
</bean>

<bean id="flatFileItemWriter" class="org.spr...FlatFileItemWriter">
  <property name="resource" ref="outputResource" />
  <property name="lineAggregator" ref="lineAggregator"/>
  <property name="footerCallback" ref="tradeItemWriter" />
</bean>
```

The way that the `TradeItemWriter` has been so far will only function correctly if the `Step` is not restartable. This is because the class is stateful (since it stores the `totalAmount`), but the `totalAmount` is not persisted to the database, and therefore, it cannot be retrieved in the event of a restart. In order to make this class restartable, the `ItemStream` interface should be implemented along with the methods `open` and `update`:

```
public void open(ExecutionContext executionContext) {
  if (executionContext.containsKey("total.amount") {
    totalAmount = (BigDecimal) executionContext.get("total.amount");
  }
}

public void update(ExecutionContext executionContext) {
  executionContext.put("total.amount", totalAmount);
}
```

The `update` method will store the most current version of `totalAmount` to the `ExecutionContext` just before that object is persisted to the database. The `open` method will retrieve any existing `totalAmount` from the `ExecutionContext` and use it as the starting point for processing, allowing the `TradeItemWriter` to pick up on restart where it left off the previous time the `Step` was executed.

11.4 Driving Query Based ItemReaders

In the chapter on readers and writers, database input using paging was discussed. Many database vendors, such as DB2, have extremely pessimistic locking strategies that can cause issues if the table being read also needs to be used by other portions of the online application. Furthermore, opening cursors over extremely large datasets can cause issues on certain vendors. Therefore, many projects prefer to use a 'Driving Query' approach to reading in data. This approach works by iterating over keys, rather than the entire object that needs to be returned, as the following example illustrates:

```
Select ID from FOO
where id > 1 and id < 7
```

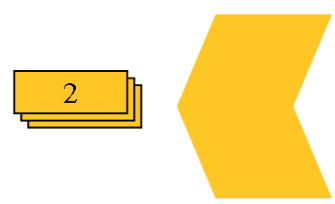

ID	NAME	BAR
1	foo1	bar1
2	foo2	bar2
3	foo3	bar3
4	foo4	bar4
5	foo5	bar5
6	foo6	bar6
7	foo7	bar7
8	foo8	bar8

As you can see, this example uses the same 'FOO' table as was used in the cursor based example. However, rather than selecting the entire row, only the ID's were selected in the SQL statement. So, rather than a FOO object being returned from `read`, an Integer will be returned. This number can then be used to query for the 'details', which is a complete Foo object:

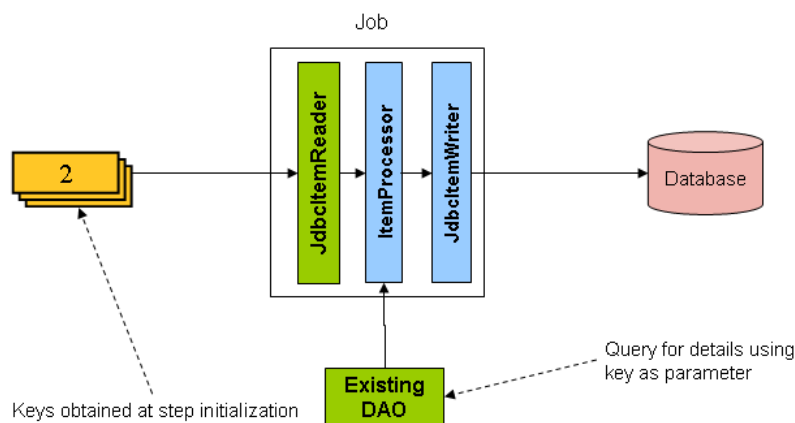

An `ItemProcessor` should be used to transform the key obtained from the driving query into a full 'Foo' object. An existing DAO can be used to query for the full object based on the key.

11.5 Multi-Line Records

While it is usually the case with flat files that one each record is confined to a single line, it is common that a file might have records spanning multiple lines with multiple formats. The following excerpt from a file illustrates this:

```
HEA:0013100345;2007-02-15
NCU;Smith;Peter;;T;20014539;F
BAD;;Oak Street 31/A;;Small Town;00235;IL;US
FOT;2;2;267.34
```

Everything between the line starting with 'HEA' and the line starting with 'FOT' is considered one record. There are a few considerations that must be made in order to handle this situation correctly:

- Instead of reading one record at a time, the `ItemReader` must read every line of the multi-line record as a group, so that it can be passed to the `ItemWriter` intact.
- Each line type may need to be tokenized differently.

Because a single record spans multiple lines, and we may not know how many lines there are, the `ItemReader` must be careful to always read an entire record. In order to do this, a custom `ItemReader` should be implemented as a wrapper for the `FlatFileItemReader`.

```
<bean id="itemReader" class="org.spr...MultiLineTradeItemReader">
  <property name="delegate">
    <bean class="org.springframework.batch.item.file.FlatFileItemReader">
      <property name="resource" value="data/iosample/input/multiLine.txt" />
      <property name="lineMapper">
        <bean class="org.spr...DefaultLineMapper">
          <property name="lineTokenizer" ref="orderFileTokenizer"/>
          <property name="fieldSetMapper">
            <bean class="org.spr...PassThroughFieldSetMapper" />
          </property>
        </bean>
      </property>
    </bean>
  </property>
</bean>
```

To ensure that each line is tokenized properly, which is especially important for fixed length input, the `PatternMatchingCompositeLineTokenizer` can be used on the delegate `FlatFileItemReader`. See the section called “Multiple Record Types within a Single File” for more details. The delegate reader will then use a `PassThroughFieldSetMapper` to deliver a `FieldSet` for each line back to the wrapping `ItemReader`.

```
<bean id="orderFileTokenizer" class="org.spr...PatternMatchingCompositeLineTokenizer">
  <property name="tokenizers">
    <map>
      <entry key="HEA*" value-ref="headerRecordTokenizer" />
      <entry key="FOT*" value-ref="footerRecordTokenizer" />
      <entry key="NCU*" value-ref="customerLineTokenizer" />
      <entry key="BAD*" value-ref="billingAddressLineTokenizer" />
    </map>
  </property>
</bean>
```

This wrapper will have to be able recognize the end of a record so that it can continually call `read()` on its delegate until the end is reached. For each line that is read, the wrapper should build up the item to be returned. Once the footer is reached, the item can be returned for delivery to the `ItemProcessor` and `ItemWriter`.

```

private FlatFileItemReader<FieldSet> delegate;

public Trade read() throws Exception {
    Trade t = null;

    for (FieldSet line = null; (line = this.delegate.read()) != null;) {
        String prefix = line.readString(0);
        if (prefix.equals("HEA")) {
            t = new Trade(); // Record must start with header
        }
        else if (prefix.equals("NCU")) {
            Assert.notNull(t, "No header was found.");
            t.setLast(line.readString(1));
            t.setFirst(line.readString(2));
            ...
        }
        else if (prefix.equals("BAD")) {
            Assert.notNull(t, "No header was found.");
            t.setCity(line.readString(4));
            t.setState(line.readString(6));
            ...
        }
        else if (prefix.equals("FOT")) {
            return t; // Record must end with footer
        }
    }
    Assert.isNull(t, "No 'END' was found.");
    return null;
}

```

11.6 Executing System Commands

Many batch jobs may require that an external command be called from within the batch job. Such a process could be kicked off separately by the scheduler, but the advantage of common meta-data about the run would be lost. Furthermore, a multi-step job would also need to be split up into multiple jobs as well.

Because the need is so common, Spring Batch provides a `Tasklet` implementation for calling system commands:

```

<bean class="org.springframework.batch.core.step.tasklet.SystemCommandTasklet">
    <property name="command" value="echo hello" />
    <!-- 5 second timeout for the command to complete -->
    <property name="timeout" value="5000" />
</bean>

```

11.7 Handling Step Completion When No Input is Found

In many batch scenarios, finding no rows in a database or file to process is not exceptional. The `Step` is simply considered to have found no work and completes with 0 items read. All of the `ItemReader` implementations provided out of the box in Spring Batch default to this approach. This can lead to some confusion if nothing is written out even when input is present. (which usually happens if a file was misnamed, etc) For this reason, the meta data itself should be inspected to determine how much work the framework found to be processed. However, what if finding no input is considered exceptional? In this case, programmatically checking the meta data for no items processed and causing failure is the best solution. Because this is a common use case, a listener is provided with just this functionality:

```

public class NoWorkFoundStepExecutionListener extends StepExecutionListenerSupport {

    public ExitStatus afterStep(StepExecution stepExecution) {
        if (stepExecution.getReadCount() == 0) {
            return ExitStatus.FAILED;
        }
        return null;
    }
}

```

The above `StepExecutionListener` inspects the `readCount` property of the `StepExecution` during the 'afterStep' phase to determine if no items were read. If that is the case, an exit code of `FAILED` is returned, indicating that the `Step` should fail. Otherwise, `null` is returned, which will not affect the status of the `Step`.

11.8 Passing Data to Future Steps

It is often useful to pass information from one step to another. This can be done using the `ExecutionContext`. The catch is that there are two `ExecutionContexts`: one at the `Step` level and one at the `Job` level. The `Step ExecutionContext` lives only as long as the step while the `Job ExecutionContext` lives through the whole `Job`. On the other hand, the `Step ExecutionContext` is updated every time the `Step` commits a chunk while the `Job ExecutionContext` is updated only at the end of each `Step`.

The consequence of this separation is that all data must be placed in the `Step ExecutionContext` while the `Step` is executing. This will ensure that the data will be stored properly while the `Step` is on-going. If data is stored to the `Job ExecutionContext`, then it will not be persisted during `Step` execution and if the `Step` fails, that data will be lost.

```

public class SavingItemWriter implements ItemWriter<Object> {
    private StepExecution stepExecution;

    public void write(List<? extends Object> items) throws Exception {
        // ...

        ExecutionContext stepContext = this.stepExecution.getExecutionContext();
        stepContext.put("someKey", someObject);
    }

    @BeforeStep
    public void saveStepExecution(StepExecution stepExecution) {
        this.stepExecution = stepExecution;
    }
}

```

To make the data available to future `Steps`, it will have to be "promoted" to the `Job ExecutionContext` after the step has finished. Spring Batch provides the `ExecutionContextPromotionListener` for this purpose. The listener must be configured with the keys related to the data in the `ExecutionContext` that must be promoted. It can also, optionally, be configured with a list of exit code patterns for which the promotion should occur ("`COMPLETED`" is the default). As with all listeners, it must be registered on the `Step`.

```
<job id="job1">
  <step id="step1">
    <tasklet>
      <chunk reader="reader" writer="savingWriter" commit-interval="10"/>
    </tasklet>
    <listeners>
      <listener ref="promotionListener"/>
    </listeners>
  </step>

  <step id="step2">
    ...
  </step>
</job>

<beans:bean id="promotionListener" class="org.spr....ExecutionContextPromotionListener">
  <beans:property name="keys" value="someKey"/>
</beans:bean>
```

Finally, the saved values must be retrieved from the `Job ExecutionContext`:

```
public class RetrievingItemWriter implements ItemWriter<Object> {
    private Object someObject;

    public void write(List<? extends Object> items) throws Exception {
        // ...
    }

    @BeforeStep
    public void retrieveInterstepData(StepExecution stepExecution) {
        JobExecution jobExecution = stepExecution.getJobExecution();
        ExecutionContext jobContext = jobExecution.getExecutionContext();
        this.someObject = jobContext.get("someKey");
    }
}
```

12. JSR-352 Support

As of Spring Batch 3.0 support for JSR-352 has been fully implemented. This section is not a replacement for the spec itself and instead, intends to explain how the JSR-352 specific concepts apply to Spring Batch. Additional information on JSR-352 can be found via the JCP here: <https://jcp.org/en/jsr/detail?id=352>

12.1 General Notes Spring Batch and JSR-352

Spring Batch and JSR-352 are structurally the same. They both have jobs that are made up of steps. They both have readers, processors, writers, and listeners. However, their interactions are subtly different. For example, the `org.springframework.batch.core.SkipListener#onSkipInWrite(S item, Throwable t)` within Spring Batch receives two parameters: the item that was skipped and the Exception that caused the skip. The JSR-352 version of the same method (`javax.batch.api.chunk.listener.SkipWriteListener#onSkipWriteItem(List<Object> items, Exception ex)`) also receives two parameters. However the first one is a `List` of all the items within the current chunk with the second being the `Exception` that caused the skip. Because of these differences, it is important to note that there are two paths to execute a job within Spring Batch: either a traditional Spring Batch job or a JSR-352 based job. While the use of Spring Batch artifacts (readers, writers, etc) will work within a job configured via JSR-352's JSL and executed via the `JsrJobOperator`, they will behave according to the rules of JSR-352. It is also important to note that batch artifacts that have been developed against the JSR-352 interfaces will not work within a traditional Spring Batch job.

12.2 Setup

Application Contexts

All JSR-352 based jobs within Spring Batch consist of two application contexts. A parent context, that contains beans related to the infrastructure of Spring Batch such as the `JobRepository`, `PlatformTransactionManager`, etc and a child context that consists of the configuration of the job to be run. The parent context is defined via the `baseContext.xml` provided by the framework. This context may be overridden via the `JSR-352-BASE-CONTEXT` system property.

Note

The base context is not processed by the JSR-352 processors for things like property injection so no components requiring that additional processing should be configured there.

Launching a JSR-352 based job

JSR-352 requires a very simple path to executing a batch job. The following code is all that is needed to execute your first batch job:

```
JobOperator operator = BatchRuntime.getJobOperator();
jobOperator.start("myJob", new Properties());
```

While that is convenient for developers, the devil is in the details. Spring Batch bootstraps a bit of infrastructure behind the scenes that a developer may want to override. The following is bootstrapped the first time `BatchRuntime.getJobOperator()` is called:

Bean Name	Default Configuration	Notes
-----------	-----------------------	-------

dataSource	Apache DBCP BasicDataSource with configured values.	By default, HSQLDB is bootstrapped.
transactionManager	org.springframework.jdbc.	References the dataSource bean defined above.
A Datasource initializer		This is configured to execute the scripts configured via the batch.drop.script and batch.schema.script properties. By default, the schema scripts for HSQLDB are executed. This behavior can be disabled via batch.data.source.init property.
jobRepository	A JDBC based SimpleJobRepository.	This JobRepository uses the previously mentioned data source and transaction manager. The schema's table prefix is configurable (defaults to BATCH_) via the batch.table.prefix property.
jobLauncher	org.springframework.batch.	Used to launch jobs.
batchJobOperator	org.springframework.batch.	The JsrJobOperator wraps this to provide most of it's functionality.
jobExplorer	org.springframework.batch.	Used to address lookup functionality provided by the JsrJobOperator.
jobParametersConverter	org.springframework.batch.	JSR-352 specific implementation of the JobParametersConverter.
jobRegistry	org.springframework.batch.	Used by the SimpleJobOperator.
placeholderProperties	org.springframework.beans.	Loads the properties. file batch- \${ENVIRONMENT:hsqldb}.properties to configure the properties mentioned above. ENVIRONMENT is a System property (defaults to hsqldb) that can be used to specify any of

the supported databases Spring Batch currently supports.

Note

None of the above beans are optional for executing JSR-352 based jobs. All may be overridden to provide customized functionality as needed.

12.3 Dependency Injection

JSR-352 is based heavily on the Spring Batch programming model. As such, while not explicitly requiring a formal dependency injection implementation, DI of some kind implied. Spring Batch supports all three methods for loading batch artifacts defined by JSR-352:

- Implementation Specific Loader - Spring Batch is built upon Spring and so supports Spring dependency injection within JSR-352 batch jobs.
- Archive Loader - JSR-352 defines the existing of a batch.xml file that provides mappings between a logical name and a class name. This file must be found within the /META-INF/ directory if it is used.
- Thread Context Class Loader - JSR-352 allows configurations to specify batch artifact implementations in their JSL by providing the fully qualified class name inline. Spring Batch supports this as well in JSR-352 configured jobs.

To use Spring dependency injection within a JSR-352 based batch job consists of configuring batch artifacts using a Spring application context as beans. Once the beans have been defined, a job can refer to them as it would any bean defined within the batch.xml.

```
<?xml version="1.0" encoding="UTF-8"?>
<beans xmlns="http://www.springframework.org/schema/beans"
       xmlns:xsi="http://www.w3.org/2001/XMLSchema-instance"
       xsi:schemaLocation="http://www.springframework.org/schema/beans
                           http://www.springframework.org/schema/beans/spring-beans.xsd
                           http://xmlns.jcp.org/xml/ns/javaee
                           http://xmlns.jcp.org/xml/ns/javaee/jobXML_1_0.xsd">

  <!-- javax.batch.api.Batchlet implementation -->
  <bean id="fooBatchlet" class="io.spring.FooBatchlet">
    <property name="prop" value="bar"/>
  </bean>

  <!-- Job is defined using the JSL schema provided in JSR-352 -->
  <job id="fooJob" xmlns="http://xmlns.jcp.org/xml/ns/javaee" version="1.0">
    <step id="step1">
      <batchlet ref="fooBatchlet"/>
    </step>
  </job>
</beans>
```

The assembly of Spring contexts (imports, etc) works with JSR-352 jobs just as it would with any other Spring based application. The only difference with a JSR-352 based job is that the entry point for the context definition will be the job definition found in /META-INF/batch-jobs/.

To use the thread context class loader approach, all you need to do is provide the fully qualified class name as the ref. It is important to note that when using this approach or the batch.xml approach, the class referenced requires a no argument constructor which will be used to create the bean.

```
<?xml version="1.0" encoding="UTF-8"?>
<job id="fooJob" xmlns="http://xmlns.jcp.org/xml/ns/javaee" version="1.0">
  <step id="step1" >
    <batchlet ref="io.spring.FooBatchlet" />
  </step>
</job>
```

12.4 Batch Properties

Property Support

JSR-352 allows for properties to be defined at the Job, Step and batch artifact level by way of configuration in the JSL. Batch properties are configured at each level in the following way:

```
<properties>
  <property name="propertyName1" value="propertyValue1"/>
  <property name="propertyName2" value="propertyValue2"/>
</properties>
```

Properties may be configured on any batch artifact.

@BatchProperty annotation

Properties are referenced in batch artifacts by annotating class fields with the `@BatchProperty` and `@Inject` annotations (both annotations are required by the spec). As defined by JSR-352, fields for properties must be String typed. Any type conversion is up to the implementing developer to perform.

An `javax.batch.api.chunk.ItemReader` artifact could be configured with a properties block such as the one described above and accessed as such:

```
public class MyItemReader extends AbstractItemReader {
    @Inject
    @BatchProperty
    private String propertyName1;

    ...
}
```

The value of the field "propertyName1" will be "propertyValue1"

Property Substitution

Property substitution is provided by way of operators and simple conditional expressions. The general usage is `#{operator['key']}`.

Supported operators:

- `jobParameters` - access job parameter values that the job was started/restarted with.
- `jobProperties` - access properties configured at the job level of the JSL.
- `systemProperties` - access named system properties.
- `partitionPlan` - access named property from the partition plan of a partitioned step.

```
#{jobParameters['unresolving.prop']}?:#{systemProperties['file.separator']}
```

The left hand side of the assignment is the expected value, the right hand side is the default value. In this example, the result will resolve to a value of the system property `file.separator` as `#{jobParameters['unresolving.prop']}` is assumed to not be resolvable. If neither expressions can be resolved, an empty String will be returned. Multiple conditions can be used, which are separated by a `';`.

12.5 Processing Models

JSR-352 provides the same two basic processing models that Spring Batch does:

- Item based processing - Using an `javax.batch.api.chunk.ItemReader`, an optional `javax.batch.api.chunk.ItemProcessor`, and an `javax.batch.api.chunk.ItemWriter`.
- Task based processing - Using a `javax.batch.api.Batchlet` implementation. This processing model is the same as the `org.springframework.batch.core.step.tasklet.Tasklet` based processing currently available.

Item based processing

Item based processing in this context is a chunk size being set by the number of items read by an `ItemReader`. To configure a step this way, specify the `item-count` (which defaults to 10) and optionally configure the `checkpoint-policy` as `item` (this is the default).

```
...
<step id="step1">
  <chunk checkpoint-policy="item" item-count="3">
    <reader ref="fooReader"/>
    <processor ref="fooProcessor"/>
    <writer ref="fooWriter"/>
  </chunk>
</step>
...
```

If item based checkpointing is chosen, an additional attribute `time-limit` is supported. This sets a time limit for how long the number of items specified has to be processed. If the timeout is reached, the chunk will complete with however many items have been read by then regardless of what the `item-count` is configured to be.

Custom checkpointing

JSR-352 calls the process around the commit interval within a step "checkpointing". Item based checkpointing is one approach as mentioned above. However, this will not be robust enough in many cases. Because of this, the spec allows for the implementation of a custom checkpointing algorithm by implementing the `javax.batch.api.chunk.CheckpointAlgorithm` interface. This functionality is functionally the same as Spring Batch's custom completion policy. To use an implementation of `CheckpointAlgorithm`, configure your step with the custom `checkpoint-policy` as shown below where `fooCheckpointer` refers to an implementation of `CheckpointAlgorithm`.

```
...
<step id="step1">
  <chunk checkpoint-policy="custom">
    <checkpoint-algorithm ref="fooCheckpointer"/>
    <reader ref="fooReader"/>
    <processor ref="fooProcessor"/>
    <writer ref="fooWriter"/>
  </chunk>
</step>
...
```

12.6 Running a job

The entrance to executing a JSR-352 based job is through the `javax.batch.operations.JobOperator`. Spring Batch provides our own implementation to this interface (`org.springframework.batch.core.jsr.launch.JsrJobOperator`). This implementation is loaded via the `javax.batch.runtime.BatchRuntime`. Launching a JSR-352 based batch job is implemented as follows:

```
JobOperator jobOperator = BatchRuntime.getJobOperator();
long jobExecutionId = jobOperator.start("fooJob", new Properties());
```

The above code does the following:

- Bootstraps a base `ApplicationContext` - In order to provide batch functionality, the framework needs some infrastructure bootstrapped. This occurs once per JVM. The components that are bootstrapped are similar to those provided by `@EnableBatchProcessing`. Specific details can be found in the javadoc for the `JsrJobOperator`.
- Loads an `ApplicationContext` for the job requested - In the example above, the framework will look in `/META-INF/batch-jobs` for a file named `fooJob.xml` and load a context that is a child of the shared context mentioned previously.
- Launch the job - The job defined within the context will be executed asynchronously. The `JobExecution`'s id will be returned.

Note

All JSR-352 based batch jobs are executed asynchronously.

When `JobOperator#start` is called using `SimpleJobOperator`, Spring Batch determines if the call is an initial run or a retry of a previously executed run. Using the JSR-352 based `JobOperator#start(String jobXMLName, Properties jobParameters)`, the framework will always create a new `JobInstance` (JSR-352 job parameters are non-identifying). In order to restart a job, a call to `JobOperator#restart(long executionId, Properties restartParameters)` is required.

12.7 Contexts

JSR-352 defines two context objects that are used to interact with the meta-data of a job or step from within a batch artifact: `javax.batch.runtime.context.JobContext` and `javax.batch.runtime.context.StepContext`. Both of these are available in any step level artifact (`Batchlet`, `ItemReader`, etc) with the `JobContext` being available to job level artifacts as well (`JobListener` for example).

To obtain a reference to the `JobContext` or `StepContext` within the current scope, simply use the `@Inject` annotation:

```
@Inject
JobContext jobContext;
```

@Autowire for JSR-352 contexts

Using Spring's @Autowire is not supported for the injection of these contexts.

In Spring Batch, the `JobContext` and `StepContext` wrap their corresponding execution objects (`JobExecution` and `StepExecution` respectively). Data stored via `StepContext#persistent#setPersistentUserData(Serializable data)` is stored in the Spring Batch `StepExecution#executionContext`.

12.8 Step Flow

Within a JSR-352 based job, the flow of steps works similarly as it does within Spring Batch. However, there are a few subtle differences:

- Decision's are steps - In a regular Spring Batch job, a decision is a state that does not have an independent `StepExecution` or any of the rights and responsibilities that go along with being a full step.. However, with JSR-352, a decision is a step just like any other and will behave just as any other steps (transactionality, it gets a `StepExecution`, etc). This means that they are treated the same as any other step on restarts as well.
- `next` attribute and step transitions - In a regular job, these are allowed to appear together in the same step. JSR-352 allows them to both be used in the same step with the `next` attribute taking precedence in evaluation.
- Transition element ordering - In a standard Spring Batch job, transition elements are sorted from most specific to least specific and evaluated in that order. JSR-352 jobs evaluate transition elements in the order they are specified in the XML.

12.9 Scaling a JSR-352 batch job

Traditional Spring Batch jobs have four ways of scaling (the last two capable of being executed across multiple JVMs):

- Split - Running multiple steps in parallel.
- Multiple threads - Executing a single step via multiple threads.
- Partitioning - Dividing the data up for parallel processing (master/slave).
- Remote Chunking - Executing the processor piece of logic remotely.

JSR-352 provides two options for scaling batch jobs. Both options support only a single JVM:

- Split - Same as Spring Batch
- Partitioning - Conceptually the same as Spring Batch however implemented slightly different.

Partitioning

Conceptually, partitioning in JSR-352 is the same as it is in Spring Batch. Meta-data is provided to each slave to identify the input to be processed with the slaves reporting back to the master the results upon completion. However, there are some important differences:

- **Partitioned Batchlet** - This will run multiple instances of the configured `Batchlet` on multiple threads. Each instance will have its own set of properties as provided by the JSL or the `PartitionPlan`
- **PartitionPlan** - With Spring Batch's partitioning, an `ExecutionContext` is provided for each partition. With JSR-352, a single `javax.batch.api.partition.PartitionPlan` is provided with an array of `Properties` providing the meta-data for each partition.
- **PartitionMapper** - JSR-352 provides two ways to generate partition meta-data. One is via the JSL (partition properties). The second is via an implementation of the `javax.batch.api.partition.PartitionMapper` interface. Functionally, this interface is similar to the `org.springframework.batch.core.partition.support.Partitioner` interface provided by Spring Batch in that it provides a way to programmatically generate meta-data for partitioning.
- **StepExecutions** - In Spring Batch, partitioned steps are run as master/slave. Within JSR-352, the same configuration occurs. However, the slave steps do not get official `StepExecutions`. Because of that, calls to `JsrJobOperator#getStepExecutions(long jobExecutionId)` will only return the `StepExecution` for the master.

Note

The child `StepExecutions` still exist in the job repository and are available via the `JobExplorer` and Spring Batch Admin.

- **Compensating logic** - Since Spring Batch implements the master/slave logic of partitioning using steps, `StepExecutionListeners` can be used to handle compensating logic if something goes wrong. However, since the slaves JSR-352 provides a collection of other components for the ability to provide compensating logic when errors occur and to dynamically set the exit status. These components include the following:

Artifact Interface	Description
<code>javax.batch.api.partition.PartitionCollector</code>	Provides a way for slave steps to send information back to the master. There is one instance per slave thread.
<code>javax.batch.api.partition.PartitionAnalyzer</code>	Endpoint that receives the information collected by the <code>PartitionCollector</code> as well as the resulting statuses from a completed partition.
<code>javax.batch.api.partition.PartitionRecovery</code>	Provides the ability to provide compensating logic for a partitioned step.

12.10 Testing

Since all JSR-352 based jobs are executed asynchronously, it can be difficult to determine when a job has completed. To help with testing, Spring Batch provides the `org.springframework.batch.core.jsr.JsrTestUtils`. This utility class provides the ability to start a job and restart a job and wait for it to complete. Once the job completes, the associated `JobExecution` is returned.

13. Spring Batch Integration

13.1. Spring Batch Integration Introduction

Many users of Spring Batch may encounter requirements that are outside the scope of Spring Batch, yet may be efficiently and concisely implemented using Spring Integration. Conversely, Spring Batch users may encounter Spring Batch requirements and need a way to efficiently integrate both frameworks. In this context several patterns and use-cases emerge and Spring Batch Integration will address those requirements.

The line between Spring Batch and Spring Integration is not always clear, but there are guidelines that one can follow. Principally, these are: think about granularity, and apply common patterns. Some of those common patterns are described in this reference manual section.

Adding messaging to a batch process enables automation of operations, and also separation and strategizing of key concerns. For example a message might trigger a job to execute, and then the sending of the message can be exposed in a variety of ways. Or when a job completes or fails that might trigger a message to be sent, and the consumers of those messages might have operational concerns that have nothing to do with the application itself. Messaging can also be embedded in a job, for example reading or writing items for processing via channels. Remote partitioning and remote chunking provide methods to distribute workloads over an number of workers.

Some key concepts that we will cover are:

- [Namespace Support](#)
- [Launching Batch Jobs through Messages](#)
- [Providing Feedback with Informational Messages](#)
- [Asynchronous Processors](#)
- [Externalizing Batch Process Execution](#)

Namespace Support

Since Spring Batch Integration 1.3, dedicated XML Namespace support was added, with the aim to provide an easier configuration experience. In order to activate the namespace, add the following namespace declarations to your Spring XML Application Context file:

```
<beans xmlns="http://www.springframework.org/schema/beans"
  xmlns:xsi="http://www.w3.org/2001/XMLSchema-instance"
  xmlns:batch-int="http://www.springframework.org/schema/batch-integration"
  xsi:schemaLocation="
    http://www.springframework.org/schema/batch-integration
    http://www.springframework.org/schema/batch-integration/spring-batch-integration.xsd">
  ...
</beans>
```

A fully configured Spring XML Application Context file for Spring Batch Integration may look like the following:

```

<beans xmlns="http://www.springframework.org/schema/beans"
  xmlns:xsi="http://www.w3.org/2001/XMLSchema-instance"
  xmlns:int="http://www.springframework.org/schema/integration"
  xmlns:batch="http://www.springframework.org/schema/batch"
  xmlns:batch-int="http://www.springframework.org/schema/batch-integration"
  xsi:schemaLocation="
    http://www.springframework.org/schema/batch-integration
    http://www.springframework.org/schema/batch-integration/spring-batch-integration.xsd
    http://www.springframework.org/schema/batch
    http://www.springframework.org/schema/batch/spring-batch.xsd
    http://www.springframework.org/schema/beans
    http://www.springframework.org/schema/beans/spring-beans.xsd
    http://www.springframework.org/schema/integration
    http://www.springframework.org/schema/integration/spring-integration.xsd">
  ...
</beans>

```

Appending version numbers to the referenced XSD file is also allowed but, as a version-less declaration will always use the latest schema, we generally don't recommend appending the version number to the XSD name. Adding a version number, for instance, would create possibly issues when updating the Spring Batch Integration dependencies as they may require more recent versions of the XML schema.

Launching Batch Jobs through Messages

When starting batch jobs using the core Spring Batch API you basically have 2 options:

- Command line via the `CommandLineJobRunner`
- Programmatically via either `JobOperator.start()` or `JobLauncher.run()`.

For example, you may want to use the `CommandLineJobRunner` when invoking Batch Jobs using a shell script. Alternatively, you may use the `JobOperator` directly, for example when using Spring Batch as part of a web application. However, what about more complex use-cases? Maybe you need to poll a remote (S)FTP server to retrieve the data for the Batch Job. Or your application has to support multiple different data sources simultaneously. For example, you may receive data files not only via the web, but also FTP etc. Maybe additional transformation of the input files is needed before invoking Spring Batch.

Therefore, it would be much more powerful to execute the batch job using Spring Integration and its numerous adapters. For example, you can use a *File Inbound Channel Adapter* to monitor a directory in the file-system and start the Batch Job as soon as the input file arrives. Additionally you can create Spring Integration flows that use multiple different adapters to easily ingest data for your Batch Jobs from multiple sources simultaneously using configuration only. Implementing all these scenarios with Spring Integration is easy as it allow for an decoupled event-driven execution of the `JobLauncher`.

Spring Batch Integration provides the `JobLaunchingMessageHandler` class that you can use to launch batch jobs. The input for the `JobLaunchingMessageHandler` is provided by a Spring Integration message, which payload is of type `JobLaunchRequest`. This class is a wrapper around the Job that needs to be launched as well as the `JobParameters` necessary to launch the Batch job.

The following image illustrates the typical Spring Integration message flow in order to start a Batch job. The [EIP \(Enterprise IntegrationPatterns\) website](#) provides a full overview of messaging icons and their descriptions.

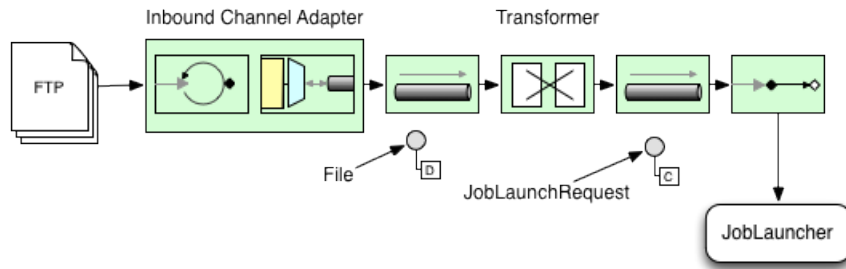

Transforming a file into a JobLaunchRequest

```

package io.spring.sbi;

import org.springframework.batch.core.Job;
import org.springframework.batch.core.JobParametersBuilder;
import org.springframework.batch.integration.launch.JobLaunchRequest;
import org.springframework.integration.annotation.Transformer;
import org.springframework.messaging.Message;

import java.io.File;

public class FileMessageToJobRequest {
    private Job job;
    private String fileParameterName;

    public void setFileParameterName(String fileParameterName) {
        this.fileParameterName = fileParameterName;
    }

    public void setJob(Job job) {
        this.job = job;
    }

    @Transformer
    public JobLaunchRequest toRequest(Message<File> message) {
        JobParametersBuilder jobParametersBuilder =
            new JobParametersBuilder();

        jobParametersBuilder.addString(fileParameterName,
            message.getPayload().getAbsolutePath());

        return new JobLaunchRequest(job, jobParametersBuilder.toJobParameters());
    }
}

```

The JobExecution Response

When a Batch Job is being executed, a `JobExecution` instance is returned. This instance can be used to determine the status of an execution. If a `JobExecution` was able to be created successfully, it will always be returned, regardless of whether or not the actual execution was successful.

The exact behavior on how the `JobExecution` instance is returned depends on the provided `TaskExecutor`. If a synchronous (single-threaded) `TaskExecutor` implementation is used, the `JobExecution` response is only returned after the job completes. When using an asynchronous `TaskExecutor`, the `JobExecution` instance is returned immediately. Users can then take the id of `JobExecution` instance (`JobExecution.getJobId()`) and query the `JobRepository` for the job's updated status using the `JobExplorer`. For more information, please refer to the Spring Batch reference documentation on [Querying the Repository](#).

The following configuration will create a file `inbound-channel-adapter` to listen for CSV files in the provided directory, hand them off to our transformer (`FileMessageToJobRequest`), launch the job

via the *Job Launching Gateway* then simply log the output of the `JobExecution` via the `logging-channel-adapter`.

Spring Batch Integration Configuration

```
<int:channel id="inboundFileChannel"/>
<int:channel id="outboundJobRequestChannel"/>
<int:channel id="jobLaunchReplyChannel"/>

<int-file:inbound-channel-adapter id="filePoller"
  channel="inboundFileChannel"
  directory="file:/tmp/myfiles/"
  filename-pattern="*.csv">
  <int:poller fixed-rate="1000"/>
</int-file:inbound-channel-adapter>

<int:transformer input-channel="inboundFileChannel"
  output-channel="outboundJobRequestChannel">
  <bean class="io.spring.sbi.FileMessageToJobRequest">
    <property name="job" ref="personJob"/>
    <property name="fileParameterName" value="input.file.name"/>
  </bean>
</int:transformer>

<batch-int:job-launching-gateway request-channel="outboundJobRequestChannel"
  reply-channel="jobLaunchReplyChannel"/>

<int:logging-channel-adapter channel="jobLaunchReplyChannel"/>
```

Now that we are polling for files and launching jobs, we need to configure for example our Spring Batch `ItemReader` to utilize found file represented by the job parameter "input.file.name":

Example ItemReader Configuration

```
<bean id="itemReader" class="org.springframework.batch.item.file.FlatFileItemReader"
  scope="step">
  <property name="resource" value="file://#{jobParameters['input.file.name']}/>
  ...
</bean>
```

The main points of interest here are injecting the value of `#{jobParameters['input.file.name']}` as the `Resource` property value and setting the `ItemReader` bean to be of *Step scope* to take advantage of the late binding support which allows access to the `jobParameters` variable.

Available Attributes of the Job-Launching Gateway

- `id` Identifies the underlying Spring bean definition, which is an instance of either:
 - `EventDrivenConsumer`
 - `PollingConsumer`

The exact implementation depends on whether the component's input channel is a:

- `SubscribableChannel` or
- `PollableChannel`
- `auto-startup` Boolean flag to indicate that the endpoint should start automatically on startup. The default is *true*.
- `request-channel` The input `MessageChannel` of this endpoint.

- `reply-channel` `Message Channel` to which the resulting `JobExecution` payload will be sent.
- `reply-timeout` Allows you to specify how long this gateway will wait for the reply message to be sent successfully to the reply channel before throwing an exception. This attribute only applies when the channel might block, for example when using a bounded queue channel that is currently full. Also, keep in mind that when sending to a `DirectChannel`, the invocation will occur in the sender's thread. Therefore, the failing of the send operation may be caused by other components further downstream. The `reply-timeout` attribute maps to the `sendTimeout` property of the underlying `MessagingTemplate` instance. The attribute will default, if not specified, to `-1`, meaning that by default, the Gateway will wait indefinitely. The value is specified in milliseconds.
- `job-launcher` Pass in a custom `JobLauncher` bean reference. This attribute is optional. If not specified the adapter will re-use the instance that is registered under the id `jobLauncher`. If no default instance exists an exception is thrown.
- `order` Specifies the order for invocation when this endpoint is connected as a subscriber to a `SubscribableChannel`.

Sub-Elements

When this Gateway is receiving messages from a `PollableChannel`, you must either provide a global default Poller or provide a Poller sub-element to the `Job Launching Gateway`:

```
<batch-int:job-launching-gateway request-channel="queueChannel"
  reply-channel="replyChannel" job-launcher="jobLauncher">
  <int:poller fixed-rate="1000"/>
</batch-int:job-launching-gateway>
```

Providing Feedback with Informational Messages

As Spring Batch jobs can run for long times, providing progress information will be critical. For example, stake-holders may want to be notified if a some or all parts of a Batch Job has failed. Spring Batch provides support for this information being gathered through:

- Active polling or
- Event-driven, using listeners.

When starting a Spring Batch job asynchronously, e.g. by using the `Job Launching Gateway`, a `JobExecution` instance is returned. Thus, `JobExecution.getJobId()` can be used to continuously poll for status updates by retrieving updated instances of the `JobExecution` from the `JobRepository` using the `JobExplorer`. However, this is considered sub-optimal and an event-driven approach should be preferred.

Therefore, Spring Batch provides listeners such as:

- `StepListener`
- `ChunkListener`
- `JobExecutionListener`

In the following example, a Spring Batch job was configured with a `StepExecutionListener`. Thus, Spring Integration will receive and process any step before/after step events. For example, the received

`StepExecution` can be inspected using a `Router`. Based on the results of that inspection, various things can occur for example routing a message to a `Mail Outbound Channel Adapter`, so that an Email notification can be send out based on some condition.

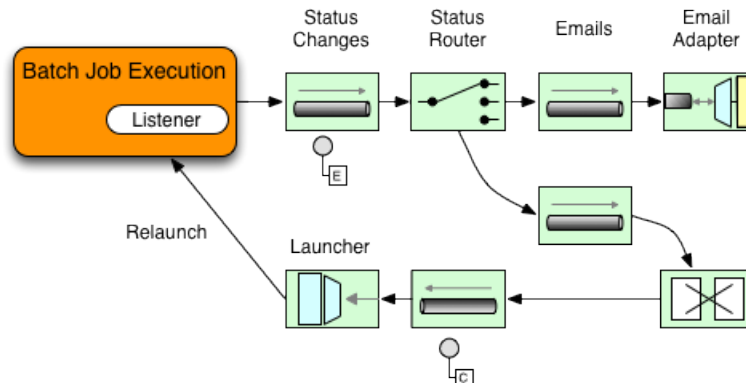

Below is an example of how a listener is configured to send a message to a `Gateway` for `StepExecution` events and log its output to a `logging-channel-adapter`:

First create the notifications integration beans:

```
<int:channel id="stepExecutionsChannel"/>

<int:gateway id="notificationExecutionsListener"
  service-interface="org.springframework.batch.core.StepExecutionListener"
  default-request-channel="stepExecutionsChannel"/>

<int:logging-channel-adapter channel="stepExecutionsChannel"/>
```

Then modify your job to add a step level listener:

```
<job id="importPayments">
  <step id="step1">
    <tasklet ../>
      <chunk ../>
        <listeners>
          <listener ref="notificationExecutionsListener"/>
        </listeners>
      </tasklet>
      ...
    </step>
  </job>
```

Asynchronous Processors

Asynchronous Processors help you to scale the processing of items. In the asynchronous processor use-case, an `AsyncItemProcessor` serves as a dispatcher, executing the `ItemProcessor`'s logic for an item on a new thread. The `Future` is passed to the `AsyncItemWriter` to be written once the processor completes.

Therefore, you can increase performance by using asynchronous item processing, basically allowing you to implement *fork-join* scenarios. The `AsyncItemWriter` will gather the results and write back the chunk as soon as all the results become available.

Configuration of both the `AsyncItemProcessor` and `AsyncItemWriter` are simple, first the `AsyncItemProcessor`:

```

<bean id="processor"
      class="org.springframework.batch.integration.async.AsyncItemProcessor">
  <property name="delegate">
    <bean class="your.ItemProcessor"/>
  </property>
  <property name="taskExecutor">
    <bean class="org.springframework.core.task.SimpleAsyncTaskExecutor"/>
  </property>
</bean>

```

The property "delegate" is actually a reference to your `ItemProcessor` bean and the "taskExecutor" property is a reference to the `TaskExecutor` of your choice.

Then we configure the `AsyncItemWriter`:

```

<bean id="itemWriter"
      class="org.springframework.batch.integration.async.AsyncItemWriter">
  <property name="delegate">
    <bean id="itemWriter" class="your.ItemWriter"/>
  </property>
</bean>

```

Again, the property "delegate" is actually a reference to your `ItemWriter` bean.

Externalizing Batch Process Execution

The integration approaches discussed so far suggest use-cases where Spring Integration wraps Spring Batch like an outer-shell. However, Spring Batch can also use Spring Integration internally. Using this approach, Spring Batch users can delegate the processing of items or even chunks to outside processes. This allows you to offload complex processing. Spring Batch Integration provides dedicated support for:

- Remote Chunking
- Remote Partitioning

Remote Chunking

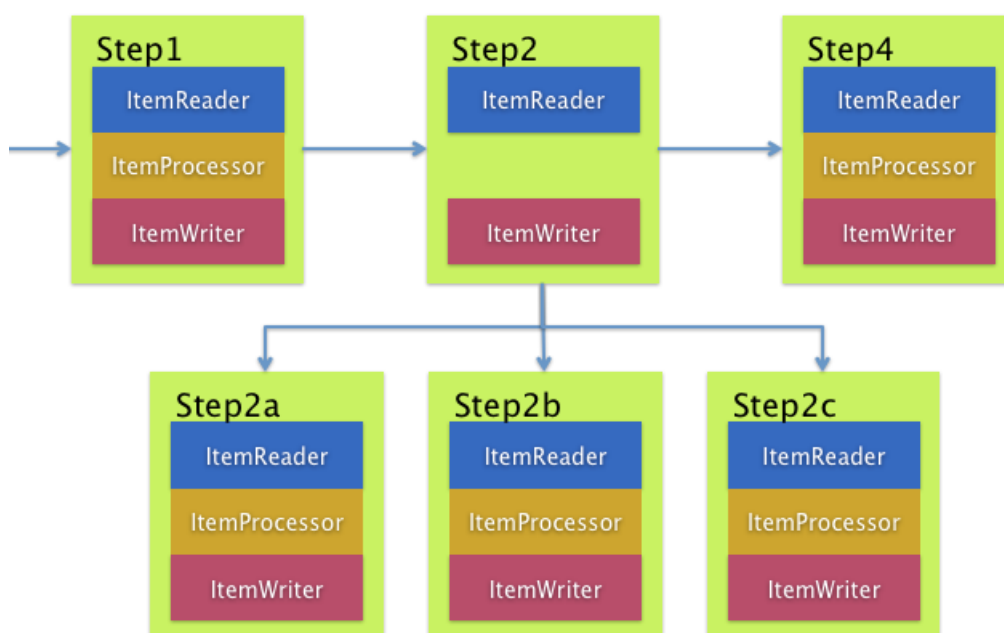

Taking things one step further, one can also externalize the chunk processing using the `ChunkMessageChannelItemWriter` which is provided by Spring Batch Integration which will send items out and collect the result. Once sent, Spring Batch will continue the process of reading and grouping items, without waiting for the results. Rather it is the responsibility of the `ChunkMessageChannelItemWriter` to gather the results and integrate them back into the Spring Batch process.

Using Spring Integration you have full control over the concurrency of your processes, for instance by using a `QueueChannel` instead of a `DirectChannel`. Furthermore, by relying on Spring Integration's rich collection of Channel Adapters (E.g. JMS or AMQP), you can distribute chunks of a Batch job to external systems for processing.

A simple job with a step to be remotely chunked would have a configuration similar to the following:

```
<job id="personJob">
  <step id="step1">
    <tasklet>
      <chunk reader="itemReader" writer="itemWriter" commit-interval="200"/>
    </tasklet>
    ...
  </step>
</job>
```

The `ItemReader` reference would point to the bean you would like to use for reading data on the master. The `ItemWriter` reference points to a special `ItemWriter` "`ChunkMessageChannelItemWriter`" as described above. The processor (if any) is left off the master configuration as it is configured on the slave. The following configuration provides a basic master setup. It's advised to check any additional component properties such as throttle limits and so on when implementing your use case.

```
<bean id="connectionFactory" class="org.apache.activemq.ActiveMQConnectionFactory">
  <property name="brokerURL" value="tcp://localhost:61616"/>
</bean>

<int-jms:outbound-channel-adapter id="requests" destination-name="requests"/>

<bean id="messagingTemplate"
  class="org.springframework.integration.core.MessagingTemplate">
  <property name="defaultChannel" ref="requests"/>
  <property name="receiveTimeout" value="2000"/>
</bean>

<bean id="itemWriter"
  class="org.springframework.batch.integration.chunk.ChunkMessageChannelItemWriter"
  scope="step">
  <property name="messagingOperations" ref="messagingTemplate"/>
  <property name="replyChannel" ref="replies"/>
</bean>

<bean id="chunkHandler"
  class="org.springframework.batch.integration.chunk.RemoteChunkHandlerFactoryBean">
  <property name="chunkWriter" ref="itemWriter"/>
  <property name="step" ref="step1"/>
</bean>

<int:channel id="replies">
  <int:queue/>
</int:channel>

<int-jms:message-driven-channel-adapter id="jmsReplies"
  destination-name="replies"
  channel="replies"/>
```

This configuration provides us with a number of beans. We configure our messaging middleware using ActiveMQ and inbound/outbound JMS adapters provided by Spring Integration. As shown, our `itemWriter` bean which is referenced by our job step utilizes the `ChunkMessageChannelItemWriter` for writing chunks over the configured middleware.

Now lets move on to the slave configuration:

```
<bean id="connectionFactory" class="org.apache.activemq.ActiveMQConnectionFactory">
  <property name="brokerURL" value="tcp://localhost:61616"/>
</bean>

<int:channel id="requests"/>
<int:channel id="replies"/>

<int-jms:message-driven-channel-adapter id="jmsIn"
  destination-name="requests"
  channel="requests"/>

<int-jms:outbound-channel-adapter id="outgoingReplies"
  destination-name="replies"
  channel="replies">
</int-jms:outbound-channel-adapter>

<int:service-activator id="serviceActivator"
  input-channel="requests"
  output-channel="replies"
  ref="chunkProcessorChunkHandler"
  method="handleChunk"/>

<bean id="chunkProcessorChunkHandler"
  class="org.springframework.batch.integration.chunk.ChunkProcessorChunkHandler">
  <property name="chunkProcessor">
    <bean class="org.springframework.batch.core.step.item.SimpleChunkProcessor">
      <property name="itemWriter">
        <bean class="io.spring.sbi.PersonItemWriter"/>
      </property>
      <property name="itemProcessor">
        <bean class="io.spring.sbi.PersonItemProcessor"/>
      </property>
    </bean>
  </property>
</bean>
```

Most of these configuration items should look familiar from the master configuration. Slaves do not need access to things like the Spring Batch `JobRepository` nor access to the actual job configuration file. The main bean of interest is the `chunkProcessorChunkHandler`. The `chunkProcessor` property of `ChunkProcessorChunkHandler` takes a configured `SimpleChunkProcessor` which is where you would provide a reference to your `ItemWriter` and optionally your `ItemProcessor` that will run on the slave when it receives chunks from the master.

For more information, please also consult the Spring Batch manual, specifically the chapter on [Remote Chunking](#).

Remote Partitioning

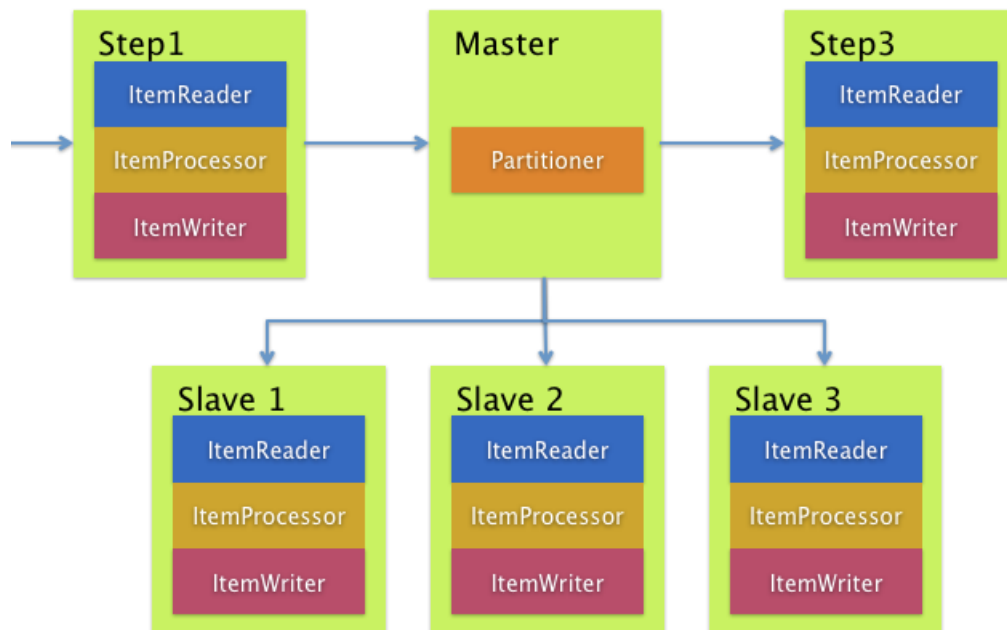

Remote Partitioning, on the other hand, is useful when the problem is not the processing of items, but the associated I/O represents the bottleneck. Using Remote Partitioning, work can be farmed out to slaves that execute complete Spring Batch steps. Thus, each slave has its own `ItemReader`, `ItemProcessor` and `ItemWriter`. For this purpose, Spring Batch Integration provides the `MessageChannelPartitionHandler`.

This implementation of the `PartitionHandler` interface uses `MessageChannel` instances to send instructions to remote workers and receive their responses. This provides a nice abstraction from the transports (E.g. JMS or AMQP) being used to communicate with the remote workers.

The reference manual section [Remote Partitioning](#) provides an overview of the concepts and components needed to configure Remote Partitioning and shows an example of using the default `TaskExecutorPartitionHandler` to partition in separate local threads of execution. For Remote Partitioning to multiple JVM's, two additional components are required:

- Remoting fabric or grid environment
- A `PartitionHandler` implementation that supports the desired remoting fabric or grid environment

Similar to Remote Chunking JMS can be used as the "remoting fabric" and the `PartitionHandler` implementation to be used as described above is the `MessageChannelPartitionHandler`. The example shown below assumes an existing partitioned job and focuses on the `MessageChannelPartitionHandler` and JMS configuration:

```

<bean id="partitionHandler"
  class="org.springframework.batch.integration.partition.MessageChannelPartitionHandler">
  <property name="stepName" value="step1"/>
  <property name="gridSize" value="3"/>
  <property name="replyChannel" ref="outbound-replies"/>
  <property name="messagingOperations">
    <bean class="org.springframework.integration.core.MessagingTemplate">
      <property name="defaultChannel" ref="outbound-requests"/>
      <property name="receiveTimeout" value="100000"/>
    </bean>
  </property>
</bean>

<int:channel id="outbound-requests"/>
<int-jms:outbound-channel-adapter destination="requestsQueue"
  channel="outbound-requests"/>

<int:channel id="inbound-requests"/>
<int-jms:message-driven-channel-adapter destination="requestsQueue"
  channel="inbound-requests"/>

<bean id="stepExecutionRequestHandler"
  class="org.springframework.batch.integration.partition.StepExecutionRequestHandler">
  <property name="jobExplorer" ref="jobExplorer"/>
  <property name="stepLocator" ref="stepLocator"/>
</bean>

<int:service-activator ref="stepExecutionRequestHandler" input-channel="inbound-requests"
  output-channel="outbound-staging"/>

<int:channel id="outbound-staging"/>
<int-jms:outbound-channel-adapter destination="stagingQueue"
  channel="outbound-staging"/>

<int:channel id="inbound-staging"/>
<int-jms:message-driven-channel-adapter destination="stagingQueue"
  channel="inbound-staging"/>

<int:aggregator ref="partitionHandler" input-channel="inbound-staging"
  output-channel="outbound-replies"/>

<int:channel id="outbound-replies">
  <int:queue/>
</int:channel>

<bean id="stepLocator"
  class="org.springframework.batch.integration.partition.BeanFactoryStepLocator" />

```

Also ensure the partition handler attribute maps to the `partitionHandler` bean:

```

<job id="personJob">
  <step id="step1.master">
    <partition partitioner="partitioner" handler="partitionHandler"/>
    ...
  </step>
</job>

```

Appendix A. List of ItemReaders and ItemWriters

A.1 Item Readers

Table A.1. Available Item Readers

Item Reader	Description
<code>AbstractItemCountingItemStreamItemReader</code>	Abstract base class that provides basic restart capabilities by counting the number of items returned from an <code>ItemReader</code> .
<code>AggregateItemReader</code>	An <code>ItemReader</code> that delivers a list as its item, storing up objects from the injected <code>ItemReader</code> until they are ready to be packed out as a collection. This <code>ItemReader</code> should mark the beginning and end of records with the constant values in <code>FieldSetMapper</code> <code>AggregateItemReader#BEGIN_RECORD</code> and <code>AggregateItemReader#END_RECORD</code>
<code>AmqpItemReader</code>	Given a Spring <code>AmqpTemplate</code> it provides synchronous receive methods. The <code>receiveAndConvert()</code> method lets you receive POJO objects.
<code>FlatFileItemReader</code>	Reads from a flat file. Includes <code>ItemStream</code> and <code>Skippable</code> functionality. See section on <code>Read from a File</code>
<code>HibernateCursorItemReader</code>	Reads from a cursor based on an HQL query. See section on <code>Reading from a Database</code>
<code>HibernatePagingItemReader</code>	Reads from a paginated HQL query
<code>IbatisPagingItemReader</code>	Reads via iBATIS based on a query. Pages through the rows so that large datasets can be read without running out of memory. See <code>HOWTO - Read from a Database</code> . This <code>ItemReader</code> is now deprecated as of Spring Batch 3.0.
<code>ItemReaderAdapter</code>	Adapts any class to the <code>ItemReader</code> interface.
<code>JdbcCursorItemReader</code>	Reads from a database cursor via JDBC. See <code>HOWTO - Read from a Database</code>
<code>JdbcPagingItemReader</code>	Given a SQL statement, pages through the rows, such that large datasets can be read without running out of memory

Item Reader	Description
JmsItemReader	Given a Spring JmsOperations object and a JMS Destination or destination name to send errors, provides items received through the injected JmsOperations receive() method
JpaPagingItemReader	Given a JPQL statement, pages through the rows, such that large datasets can be read without running out of memory
ListItemReader	Provides the items from a list, one at a time
MongoItemReader	Given a MongoOperations object and JSON based MongoDB query, provides items received from the MongoOperations find method
Neo4jItemReader	Given a Neo4jOperations object and the components of a Cypher query, items are returned as the result of the Neo4jOperations.query method
RepositoryItemReader	Given a Spring Data PagingAndSortingRepository object, a Sort and the name of method to execute, returns items provided by the Spring Data repository implementation
StoredProcedureItemReader	Reads from a database cursor resulting from the execution of a database stored procedure. See HOWTO - Read from a Database
StaxEventItemReader	Reads via StAX. See HOWTO - Read from a File

A.2 Item Writers

Table A.2. Available Item Writers

Item Writer	Description
AbstractItemStreamItemWriter	Abstract base class that combines the <code>ItemStream</code> and <code>ItemWriter</code> interfaces.
AmqpItemWriter	Given a Spring AmqpTemplate it provides for synchronous send method. The <code>convertAndSend(Object)</code> method lets you send POJO objects.
CompositeItemWriter	Passes an item to the process method of each in an injected List of ItemWriter objects
FlatFileItemWriter	Writes to a flat file. Includes <code>ItemStream</code> and <code>Skippable</code> functionality. See section on Writing to a File

Item Writer	Description
GemfireItemWriter	Using a GemfireOperations object, items are either written or removed from the Gemfire instance based on the configuration of the delete flag
HibernateItemWriter	This item writer is hibernate session aware and handles some transaction-related work that a non-"hibernate aware" item writer would not need to know about and then delegates to another item writer to do the actual writing.
IbatisBatchItemWriter	Writes items in a batch using the iBatis API's directly. This ItemWriter is deprecated as of Spring Batch 3.0.
ItemWriterAdapter	Adapts any class to the ItemWriter interface.
JdbcBatchItemWriter	Uses batching features from a PreparedStatement, if available, and can take rudimentary steps to locate a failure during a flush.
JmsItemWriter	Using a JmsOperations object, items are written to the default queue via the JmsOperations.convertAndSend() method
JpaItemWriter	This item writer is JPA EntityManager aware and handles some transaction-related work that a non-"jpa aware" ItemWriter would not need to know about and then delegates to another writer to do the actual writing.
MimeMessageItemWriter	Using Spring's JavaMailSender, items of type MimeMessage are sent as mail messages
MongoItemWriter	Given a MongoOperations object, items are written via the MongoOperations.save(Object) method. The actual write is delayed until the last possible moment before the transaction commits.
Neo4jItemWriter	Given a Neo4jOperations object, items are persisted via the save(Object) method or deleted via the delete(Object) per the ItemWriter's configuration
PropertyExtractingDelegatingItemWriter	Extends AbstractMethodInvokingDelegator creating arguments on the fly. Arguments are created by retrieving the values from the fields in the item to be processed (via a SpringBeanWrapper) based on an injected array of field name

Item Writer	Description
RepositoryItemWriter	Given a Spring Data CrudRepository implementation, items are saved via the method specified in the configuration.
StaxEventItemWriter	Uses an ObjectToXmlSerializer implementation to convert each item to XML and then writes it to an XML file using StAX.

Appendix B. Meta-Data Schema

B.1 Overview

The Spring Batch Meta-Data tables very closely match the Domain objects that represent them in Java. For example, `JobInstance`, `JobExecution`, `JobParameters`, and `StepExecution` map to `BATCH_JOB_INSTANCE`, `BATCH_JOB_EXECUTION`, `BATCH_JOB_EXECUTION_PARAMS`, and `BATCH_STEP_EXECUTION`, respectively. `ExecutionContext` maps to both `BATCH_JOB_EXECUTION_CONTEXT` and `BATCH_STEP_EXECUTION_CONTEXT`. The `JobRepository` is responsible for saving and storing each Java object into its correct table. The following appendix describes the meta-data tables in detail, along with many of the design decisions that were made when creating them. When viewing the various table creation statements below, it is important to realize that the data types used are as generic as possible. Spring Batch provides many schemas as examples, which all have varying data types due to variations in individual database vendors' handling of data types. Below is an ERD model of all 6 tables and their relationships to one another:

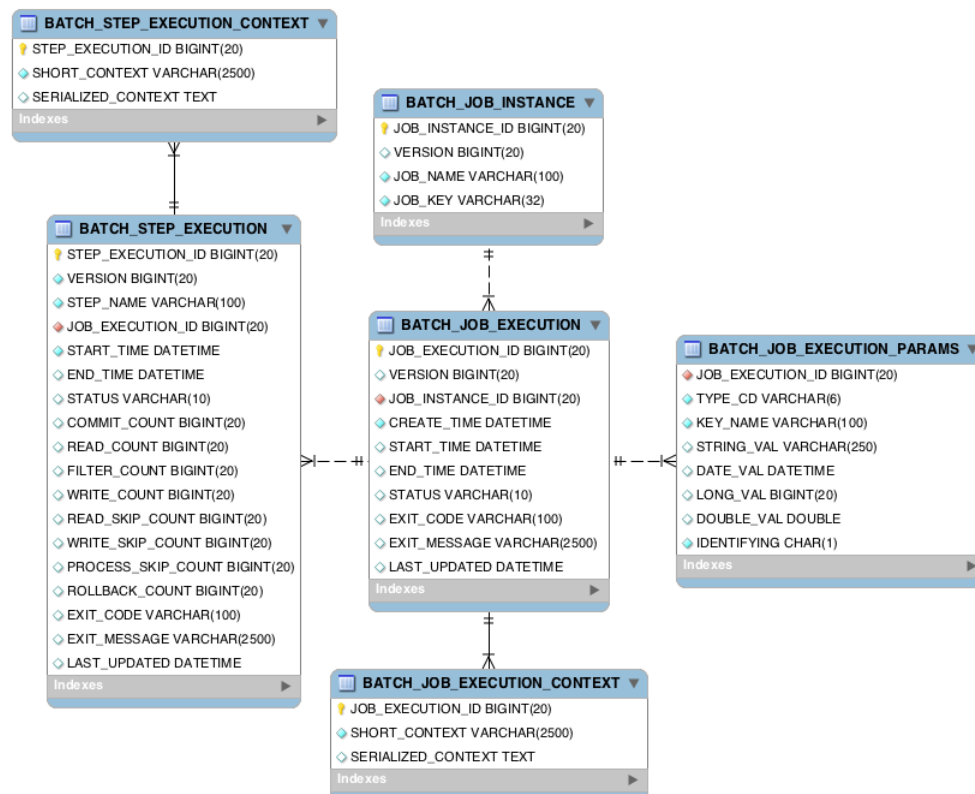

Example DDL Scripts

The Spring Batch Core JAR file contains example scripts to create the relational tables for a number of database platforms (which are in turn auto-detected by the job repository factory bean or namespace equivalent). These scripts can be used as is, or modified with additional indexes and constraints as desired. The file names are in the form `schema-*.sql`, where "*" is the short name of the target database platform. The scripts are in the package `org.springframework.batch.core`.

Version

Many of the database tables discussed in this appendix contain a version column. This column is important because Spring Batch employs an optimistic locking strategy when dealing with updates to the database. This means that each time a record is 'touched' (updated) the value in the version column is incremented by one. When the repository goes back to try and save the value, if the version number has change it will throw `OptimisticLockingFailureException`, indicating there has been an error with concurrent access. This check is necessary since, even though different batch jobs may be running in different machines, they are all using the same database tables.

Identity

`BATCH_JOB_INSTANCE`, `BATCH_JOB_EXECUTION`, and `BATCH_STEP_EXECUTION` each contain columns ending in `_ID`. These fields act as primary keys for their respective tables. However, they are not database generated keys, but rather they are generated by separate sequences. This is necessary because after inserting one of the domain objects into the database, the key it is given needs to be set on the actual object so that they can be uniquely identified in Java. Newer database drivers (Jdbc 3.0 and up) support this feature with database generated keys, but rather than requiring it, sequences were used. Each variation of the schema will contain some form of the following:

```
CREATE SEQUENCE BATCH_STEP_EXECUTION_SEQ;
CREATE SEQUENCE BATCH_JOB_EXECUTION_SEQ;
CREATE SEQUENCE BATCH_JOB_SEQ;
```

Many database vendors don't support sequences. In these cases, work-arounds are used, such as the following for MySQL:

```
CREATE TABLE BATCH_STEP_EXECUTION_SEQ (ID BIGINT NOT NULL) type=InnoDB;
INSERT INTO BATCH_STEP_EXECUTION_SEQ values(0);
CREATE TABLE BATCH_JOB_EXECUTION_SEQ (ID BIGINT NOT NULL) type=InnoDB;
INSERT INTO BATCH_JOB_EXECUTION_SEQ values(0);
CREATE TABLE BATCH_JOB_SEQ (ID BIGINT NOT NULL) type=InnoDB;
INSERT INTO BATCH_JOB_SEQ values(0);
```

In the above case, a table is used in place of each sequence. The Spring core class `MySQLMaxValueIncrementer` will then increment the one column in this sequence in order to give similar functionality.

B.2 BATCH_JOB_INSTANCE

The `BATCH_JOB_INSTANCE` table holds all information relevant to a `JobInstance`, and serves as the top of the overall hierarchy. The following generic DDL statement is used to create it:

```
CREATE TABLE BATCH_JOB_INSTANCE (
  JOB_INSTANCE_ID BIGINT PRIMARY KEY ,
  VERSION BIGINT,
  JOB_NAME VARCHAR(100) NOT NULL ,
  JOB_KEY VARCHAR(2500)
);
```

Below are descriptions of each column in the table:

- `JOB_INSTANCE_ID`: The unique id that will identify the instance, which is also the primary key. The value of this column should be obtainable by calling the `getId` method on `JobInstance`.
- `VERSION`: See above section.

- **JOB_NAME:** Name of the job obtained from the `Job` object. Because it is required to identify the instance, it must not be null.
- **JOB_KEY:** A serialization of the `JobParameters` that uniquely identifies separate instances of the same job from one another. (`JobInstances` with the same job name must have different `JobParameters`, and thus, different `JOB_KEY` values).

B.3 BATCH_JOB_EXECUTION_PARAMS

The `BATCH_JOB_EXECUTION_PARAMS` table holds all information relevant to the `JobParameters` object. It contains 0 or more key/value pairs passed to a `Job` and serve as a record of the parameters a job was run with. For each parameter that contributes to the generation of a job's identity, the `IDENTIFYING` flag is set to true. It should be noted that the table has been denormalized. Rather than creating a separate table for each type, there is one table with a column indicating the type:

```
CREATE TABLE BATCH_JOB_EXECUTION_PARAMS (
  JOB_EXECUTION_ID BIGINT NOT NULL ,
  TYPE_CD VARCHAR(6) NOT NULL ,
  KEY_NAME VARCHAR(100) NOT NULL ,
  STRING_VAL VARCHAR(250) ,
  DATE_VAL DATETIME DEFAULT NULL ,
  LONG_VAL BIGINT ,
  DOUBLE_VAL DOUBLE PRECISION ,
  IDENTIFYING CHAR(1) NOT NULL ,
  constraint JOB_EXEC_PARAMS_FK foreign key (JOB_EXECUTION_ID)
  references BATCH_JOB_EXECUTION(JOB_EXECUTION_ID)
);
```

Below are descriptions for each column:

- **JOB_EXECUTION_ID:** Foreign Key from the `BATCH_JOB_EXECUTION` table that indicates the job execution the parameter entry belongs to. It should be noted that multiple rows (i.e key/value pairs) may exist for each execution.
- **TYPE_CD:** String representation of the type of value stored, which can be either a string, date, long, or double. Because the type must be known, it cannot be null.
- **KEY_NAME:** The parameter key.
- **STRING_VAL:** Parameter value, if the type is string.
- **DATE_VAL:** Parameter value, if the type is date.
- **LONG_VAL:** Parameter value, if the type is a long.
- **DOUBLE_VAL:** Parameter value, if the type is double.
- **IDENTIFYING:** Flag indicating if the parameter contributed to the identity of the related `JobInstance`.

It is worth noting that there is no primary key for this table. This is simply because the framework has no use for one, and thus doesn't require it. If a user so chooses, one may be added with a database generated key, without causing any issues to the framework itself.

B.4 BATCH_JOB_EXECUTION

The `BATCH_JOB_EXECUTION` table holds all information relevant to the `JobExecution` object. Every time a `Job` is run there will always be a new `JobExecution`, and a new row in this table:

```

CREATE TABLE BATCH_JOB_EXECUTION (
  JOB_EXECUTION_ID BIGINT PRIMARY KEY ,
  VERSION BIGINT,
  JOB_INSTANCE_ID BIGINT NOT NULL,
  CREATE_TIME TIMESTAMP NOT NULL,
  START_TIME TIMESTAMP DEFAULT NULL,
  END_TIME TIMESTAMP DEFAULT NULL,
  STATUS VARCHAR(10),
  EXIT_CODE VARCHAR(20),
  EXIT_MESSAGE VARCHAR(2500),
  LAST_UPDATED TIMESTAMP,
  JOB_CONFIGURATION_LOCATION VARCHAR(2500) NULL,
  constraint JOB_INSTANCE_EXECUTION_FK foreign key (JOB_INSTANCE_ID)
  references BATCH_JOB_INSTANCE(JOB_INSTANCE_ID)
) ;

```

Below are descriptions for each column:

- **JOB_EXECUTION_ID**: Primary key that uniquely identifies this execution. The value of this column is obtainable by calling the `getId` method of the `JobExecution` object.
- **VERSION**: See above section.
- **JOB_INSTANCE_ID**: Foreign key from the `BATCH_JOB_INSTANCE` table indicating the instance to which this execution belongs. There may be more than one execution per instance.
- **CREATE_TIME**: Timestamp representing the time that the execution was created.
- **START_TIME**: Timestamp representing the time the execution was started.
- **END_TIME**: Timestamp representing the time the execution was finished, regardless of success or failure. An empty value in this column even though the job is not currently running indicates that there has been some type of error and the framework was unable to perform a last save before failing.
- **STATUS**: Character string representing the status of the execution. This may be `COMPLETED`, `STARTED`, etc. The object representation of this column is the `BatchStatus` enumeration.
- **EXIT_CODE**: Character string representing the exit code of the execution. In the case of a command line job, this may be converted into a number.
- **EXIT_MESSAGE**: Character string representing a more detailed description of how the job exited. In the case of failure, this might include as much of the stack trace as is possible.
- **LAST_UPDATED**: Timestamp representing the last time this execution was persisted.

B.5 BATCH_STEP_EXECUTION

The `BATCH_STEP_EXECUTION` table holds all information relevant to the `StepExecution` object. This table is very similar in many ways to the `BATCH_JOB_EXECUTION` table and there will always be at least one entry per `Step` for each `JobExecution` created:

```

CREATE TABLE BATCH_STEP_EXECUTION (
  STEP_EXECUTION_ID BIGINT PRIMARY KEY ,
  VERSION BIGINT NOT NULL ,
  STEP_NAME VARCHAR(100) NOT NULL ,
  JOB_EXECUTION_ID BIGINT NOT NULL ,
  START_TIME TIMESTAMP NOT NULL ,
  END_TIME TIMESTAMP DEFAULT NULL ,
  STATUS VARCHAR(10) ,
  COMMIT_COUNT BIGINT ,
  READ_COUNT BIGINT ,
  FILTER_COUNT BIGINT ,
  WRITE_COUNT BIGINT ,
  READ_SKIP_COUNT BIGINT ,
  WRITE_SKIP_COUNT BIGINT ,
  PROCESS_SKIP_COUNT BIGINT ,
  ROLLBACK_COUNT BIGINT ,
  EXIT_CODE VARCHAR(20) ,
  EXIT_MESSAGE VARCHAR(2500) ,
  LAST_UPDATED TIMESTAMP ,
  constraint JOB_EXECUTION_STEP_FK foreign key (JOB_EXECUTION_ID)
  references BATCH_JOB_EXECUTION(JOB_EXECUTION_ID)
) ;

```

Below are descriptions for each column:

- **STEP_EXECUTION_ID**: Primary key that uniquely identifies this execution. The value of this column should be obtainable by calling the `getId` method of the `StepExecution` object.
- **VERSION**: See above section.
- **STEP_NAME**: The name of the step to which this execution belongs.
- **JOB_EXECUTION_ID**: Foreign key from the `BATCH_JOB_EXECUTION` table indicating the `JobExecution` to which this `StepExecution` belongs. There may be only one `StepExecution` for a given `JobExecution` for a given `Step` name.
- **START_TIME**: Timestamp representing the time the execution was started.
- **END_TIME**: Timestamp representing the time the execution was finished, regardless of success or failure. An empty value in this column even though the job is not currently running indicates that there has been some type of error and the framework was unable to perform a last save before failing.
- **STATUS**: Character string representing the status of the execution. This may be `COMPLETED`, `STARTED`, etc. The object representation of this column is the `BatchStatus` enumeration.
- **COMMIT_COUNT**: The number of times in which the step has committed a transaction during this execution.
- **READ_COUNT**: The number of items read during this execution.
- **FILTER_COUNT**: The number of items filtered out of this execution.
- **WRITE_COUNT**: The number of items written and committed during this execution.
- **READ_SKIP_COUNT**: The number of items skipped on read during this execution.
- **WRITE_SKIP_COUNT**: The number of items skipped on write during this execution.
- **PROCESS_SKIP_COUNT**: The number of items skipped during processing during this execution.

- **ROLLBACK_COUNT**: The number of rollbacks during this execution. Note that this count includes each time rollback occurs, including rollbacks for retry and those in the skip recovery procedure.
- **EXIT_CODE**: Character string representing the exit code of the execution. In the case of a command line job, this may be converted into a number.
- **EXIT_MESSAGE**: Character string representing a more detailed description of how the job exited. In the case of failure, this might include as much of the stack trace as is possible.
- **LAST_UPDATED**: Timestamp representing the last time this execution was persisted.

B.6 BATCH_JOB_EXECUTION_CONTEXT

The `BATCH_JOB_EXECUTION_CONTEXT` table holds all information relevant to an `Job`'s `ExecutionContext`. There is exactly one `Job ExecutionContext` per `JobExecution`, and it contains all of the job-level data that is needed for a particular job execution. This data typically represents the state that must be retrieved after a failure so that a `JobInstance` can 'start from where it left off'.

```
CREATE TABLE BATCH_JOB_EXECUTION_CONTEXT (
  JOB_EXECUTION_ID BIGINT PRIMARY KEY,
  SHORT_CONTEXT VARCHAR(2500) NOT NULL,
  SERIALIZED_CONTEXT CLOB,
  constraint JOB_EXEC_CTX_FK foreign key (JOB_EXECUTION_ID)
  references BATCH_JOB_EXECUTION(JOB_EXECUTION_ID)
) ;
```

Below are descriptions for each column:

- **JOB_EXECUTION_ID**: Foreign key representing the `JobExecution` to which the context belongs. There may be more than one row associated to a given execution.
- **SHORT_CONTEXT**: A string version of the `SERIALIZED_CONTEXT`.
- **SERIALIZED_CONTEXT**: The entire context, serialized.

B.7 BATCH_STEP_EXECUTION_CONTEXT

The `BATCH_STEP_EXECUTION_CONTEXT` table holds all information relevant to an `Step`'s `ExecutionContext`. There is exactly one `ExecutionContext` per `StepExecution`, and it contains all of the data that needs to be persisted for a particular step execution. This data typically represents the state that must be retrieved after a failure so that a `JobInstance` can 'start from where it left off'.

```
CREATE TABLE BATCH_STEP_EXECUTION_CONTEXT (
  STEP_EXECUTION_ID BIGINT PRIMARY KEY,
  SHORT_CONTEXT VARCHAR(2500) NOT NULL,
  SERIALIZED_CONTEXT CLOB,
  constraint STEP_EXEC_CTX_FK foreign key (STEP_EXECUTION_ID)
  references BATCH_STEP_EXECUTION(STEP_EXECUTION_ID)
) ;
```

Below are descriptions for each column:

- **STEP_EXECUTION_ID**: Foreign key representing the `StepExecution` to which the context belongs. There may be more than one row associated to a given execution.
- **SHORT_CONTEXT**: A string version of the `SERIALIZED_CONTEXT`.

- `SERIALIZED_CONTEXT`: The entire context, serialized.

B.8 Archiving

Because there are entries in multiple tables every time a batch job is run, it is common to create an archive strategy for the meta-data tables. The tables themselves are designed to show a record of what happened in the past, and generally won't affect the run of any job, with a couple of notable exceptions pertaining to restart:

- The framework will use the meta-data tables to determine if a particular `JobInstance` has been run before. If it has been run, and the job is not restartable, then an exception will be thrown.
- If an entry for a `JobInstance` is removed without having completed successfully, the framework will think that the job is new, rather than a restart.
- If a job is restarted, the framework will use any data that has been persisted to the `ExecutionContext` to restore the Job's state. Therefore, removing any entries from this table for jobs that haven't completed successfully will prevent them from starting at the correct point if run again.

B.9 International and Multi-byte Characters

If you are using multi-byte character sets (e.g. Chinese or Cyrillic) in your business processing, then those characters might need to be persisted in the Spring Batch schema. Many users find that simply changing the schema to double the length of the `VARCHAR` columns is enough. Others prefer to configure the `JobRepository` with `max-varchar-length` half the value of the `VARCHAR` column length is enough. Some users have also reported that they use `NVARCHAR` in place of `VARCHAR` in their schema definitions. The best result will depend on the database platform and the way the database server has been configured locally.

B.10 Recommendations for Indexing Meta Data Tables

Spring Batch provides DDL samples for the meta-data tables in the Core jar file for several common database platforms. Index declarations are not included in that DDL because there are too many variations in how users may want to index depending on their precise platform, local conventions and also the business requirements of how the jobs will be operated. The table below provides some indication as to which columns are going to be used in a `WHERE` clause by the Dao implementations provided by Spring Batch, and how frequently they might be used, so that individual projects can make up their own minds about indexing.

Table B.1. Where clauses in SQL statements (excluding primary keys) and their approximate frequency of use.

Default Table Name	Where Clause	Frequency
<code>BATCH_JOB_INSTANCE</code>	<code>JOB_NAME = ? and JOB_KEY = ?</code>	Every time a job is launched
<code>BATCH_JOB_EXECUTION</code>	<code>JOB_INSTANCE_ID = ?</code>	Every time a job is restarted
<code>BATCH_EXECUTION_CONTEXT</code>	<code>EXECUTION_ID = ? and KEY_NAME = ?</code>	On commit interval, a.k.a. chunk
<code>BATCH_STEP_EXECUTION</code>	<code>VERSION = ?</code>	On commit interval, a.k.a. chunk (and at start and end of step)

BATCH_STEP_EXECUTION	STEP_NAME = ? and JOB_EXECUTION_ID = ?	Before each step execution
----------------------	---	----------------------------

Appendix C. Batch Processing and Transactions

C.1 Simple Batching with No Retry

Consider the following simple example of a nested batch with no retries. This is a very common scenario for batch processing, where an input source is processed until exhausted, but we commit periodically at the end of a "chunk" of processing.

```

1 | REPEAT(until=exhausted) {
|
2 |   TX {
3 |     REPEAT(size=5) {
3.1 |       input;
3.2 |       output;
|     }
|   }
| }

```

The input operation (3.1) could be a message-based receive (e.g. JMS), or a file-based read, but to recover and continue processing with a chance of completing the whole job, it must be transactional. The same applies to the operation at (3.2) - it must be either transactional or idempotent.

If the chunk at REPEAT(3) fails because of a database exception at (3.2), then TX(2) will roll back the whole chunk.

C.2 Simple Stateless Retry

It is also useful to use a retry for an operation which is not transactional, like a call to a web-service or other remote resource. For example:

```

0 | TX {
1 |   input;
1.1 |   output;
2 |   RETRY {
2.1 |     remote access;
|   }
| }

```

This is actually one of the most useful applications of a retry, since a remote call is much more likely to fail and be retryable than a database update. As long as the remote access (2.1) eventually succeeds, the transaction TX(0) will commit. If the remote access (2.1) eventually fails, then the transaction TX(0) is guaranteed to roll back.

C.3 Typical Repeat-Retry Pattern

The most typical batch processing pattern is to add a retry to the inner block of the chunk in the Simple Batching example. Consider this:

```

1 | REPEAT(until=exhausted, exception=not critical) {
  |
2 |   TX {
3 |     REPEAT(size=5) {
  |
4 |       RETRY(stateful, exception=deadlock loser) {
4.1 |         input;
5 |       } PROCESS {
5.1 |         output;
6 |       } SKIP and RECOVER {
  |         notify;
  |       }
  |
  |     }
  |   }
  | }

```

The inner RETRY(4) block is marked as "stateful" - see the typical use case for a description of a stateful retry. This means that if the the retry PROCESS(5) block fails, the behaviour of the RETRY(4) is as follows.

- Throw an exception, rolling back the transaction TX(2) at the chunk level, and allowing the item to be re-presented to the input queue.
- When the item re-appears, it might be retried depending on the retry policy in place, executing PROCESS(5) again. The second and subsequent attempts might fail again and rethrow the exception.
- Eventually the item re-appears for the final time: the retry policy disallows another attempt, so PROCESS(5) is never executed. In this case we follow a RECOVER(6) path, effectively "skipping" the item that was received and is being processed.

Notice that the notation used for the RETRY(4) in the plan above shows explicitly that the the input step (4.1) is part of the retry. It also makes clear that there are two alternate paths for processing: the normal case is denoted by PROCESS(5), and the recovery path is a separate block, RECOVER(6). The two alternate paths are completely distinct: only one is ever taken in normal circumstances.

In special cases (e.g. a special `TransactionValidException` type), the retry policy might be able to determine that the RECOVER(6) path can be taken on the last attempt after PROCESS(5) has just failed, instead of waiting for the item to be re-presented. This is not the default behavior because it requires detailed knowledge of what has happened inside the PROCESS(5) block, which is not usually available - e.g. if the output included write access before the failure, then the exception should be rethrown to ensure transactional integrity.

The completion policy in the outer, REPEAT(1) is crucial to the success of the above plan. If the output(5.1) fails it may throw an exception (it usually does, as described), in which case the transaction TX(2) fails and the exception could propagate up through the outer batch REPEAT(1). We do not want the whole batch to stop because the RETRY(4) might still be successful if we try again, so we add the `exception=not critical` to the outer REPEAT(1).

Note, however, that if the TX(2) fails and we *do* try again, by virtue of the outer completion policy, the item that is next processed in the inner REPEAT(3) is not guaranteed to be the one that just failed. It might well be, but it depends on the implementation of the input(4.1). Thus the output(5.1) might fail again, on a new item, or on the old one. The client of the batch should not assume that each RETRY(4) attempt is going to process the same items as the last one that failed. E.g. if the termination policy for

REPEAT(1) is to fail after 10 attempts, it will fail after 10 consecutive attempts, but not necessarily at the same item. This is consistent with the overall retry strategy: it is the inner RETRY(4) that is aware of the history of each item, and can decide whether or not to have another attempt at it.

C.4 Asynchronous Chunk Processing

The inner batches or chunks in the typical example above can be executed concurrently by configuring the outer batch to use an `AsyncTaskExecutor`. The outer batch waits for all the chunks to complete before completing.

```

1 | REPEAT(until=exhausted, concurrent, exception=not critical) {
|
2 |     TX {
3 |         REPEAT(size=5) {
|
4 |             RETRY(stateful, exception=deadlock loser) {
4.1 |                 input;
5 |             } PROCESS {
|                 output;
6 |             } RECOVER {
|                 recover;
|             }
|         }
|     }
| }

```

C.5 Asynchronous Item Processing

The individual items in chunks in the typical can also in principle be processed concurrently. In this case the transaction boundary has to move to the level of the individual item, so that each transaction is on a single thread:

```

1 | REPEAT(until=exhausted, exception=not critical) {
|
2 |     REPEAT(size=5, concurrent) {
|
3 |         TX {
4 |             RETRY(stateful, exception=deadlock loser) {
4.1 |                 input;
5 |             } PROCESS {
|                 output;
6 |             } RECOVER {
|                 recover;
|             }
|         }
|     }
| }

```

This plan sacrifices the optimisation benefit, that the simple plan had, of having all the transactional resources chunked together. It is only useful if the cost of the processing (5) is much higher than the cost of transaction management (3).

C.6 Interactions Between Batching and Transaction Propagation

There is a tighter coupling between batch-retry and TX management than we would ideally like. In particular a stateless retry cannot be used to retry database operations with a transaction manager that doesn't support NESTED propagation.

For a simple example using retry without repeat, consider this:

```

1 | TX {
|
1.1 | input;
2.2 | database access;
2 | RETRY {
3 | TX {
3.1 | database access;
| }
| }
|
| }

```

Again, and for the same reason, the inner transaction TX(3) can cause the outer transaction TX(1) to fail, even if the RETRY(2) is eventually successful.

Unfortunately the same effect percolates from the retry block up to the surrounding repeat batch if there is one:

```

1 | TX {
|
2 | REPEAT(size=5) {
2.1 | input;
2.2 | database access;
3 | RETRY {
4 | TX {
4.1 | database access;
| }
| }
| }
|
| }

```

Now if TX(3) rolls back it can pollute the whole batch at TX(1) and force it to roll back at the end.

What about non-default propagation?

- In the last example `PROPAGATION_REQUIRES_NEW` at TX(3) will prevent the outer TX(1) from being polluted if both transactions are eventually successful. But if TX(3) commits and TX(1) rolls back, then TX(3) stays committed, so we violate the transaction contract for TX(1). If TX(3) rolls back, TX(1) does not necessarily (but it probably will in practice because the retry will throw a roll back exception).
- `PROPAGATION_NESTED` at TX(3) works as we require in the retry case (and for a batch with skips): TX(3) can commit, but subsequently be rolled back by the outer transaction TX(1). If TX(3) rolls back, again TX(1) will roll back in practice. This option is only available on some platforms, e.g. not Hibernate or JTA, but it is the only one that works consistently.

So NESTED is best if the retry block contains any database access.

C.7 Special Case: Transactions with Orthogonal Resources

Default propagation is always OK for simple cases where there are no nested database transactions. Consider this (where the SESSION and TX are not global XA resources, so their resources are orthogonal):

```

0 | SESSION {
1 |   input;
2 |   RETRY {
3 |     TX {
3.1 |       database access;
   |     }
   |   }
   | }

```

Here there is a transactional message SESSION(0), but it doesn't participate in other transactions with `PlatformTransactionManager`, so doesn't propagate when TX(3) starts. There is no database access outside the RETRY(2) block. If TX(3) fails and then eventually succeeds on a retry, SESSION(0) can commit (it can do this independent of a TX block). This is similar to the vanilla "best-efforts-one-phase-commit" scenario - the worst that can happen is a duplicate message when the RETRY(2) succeeds and the SESSION(0) cannot commit, e.g. because the message system is unavailable.

C.8 Stateless Retry Cannot Recover

The distinction between a stateless and a stateful retry in the typical example above is important. It is actually ultimately a transactional constraint that forces the distinction, and this constraint also makes it obvious why the distinction exists.

We start with the observation that there is no way to skip an item that failed and successfully commit the rest of the chunk unless we wrap the item processing in a transaction. So we simplify the typical batch execution plan to look like this:

```

0 | REPEAT(until=exhausted) {
  |
1 |   TX {
2 |     REPEAT(size=5) {
  |
3 |       RETRY(stateless) {
4 |         TX {
4.1 |           input;
4.2 |           database access;
   |         }
5 |       } RECOVER {
5.1 |         skip;
   |       }
   |     }
   |   }
   | }

```

Here we have a stateless RETRY(3) with a RECOVER(5) path that kicks in after the final attempt fails. The "stateless" label just means that the block will be repeated without rethrowing any exception up to some limit. This will only work if the transaction TX(4) has propagation NESTED.

If the TX(3) has default propagation properties and it rolls back, it will pollute the outer TX(1). The inner transaction is assumed by the transaction manager to have corrupted the transactional resource, and so it cannot be used again.

Support for NESTED propagation is sufficiently rare that we choose not to support recovery with stateless retries in current versions of Spring Batch. The same effect can always be achieved (at the expense of repeating more processing) using the typical pattern above.

Glossary

Spring Batch Glossary

Batch	An accumulation of business transactions over time.
Batch Application Style	Term used to designate batch as an application style in its own right similar to online, Web or SOA. It has standard elements of input, validation, transformation of information to business model, business processing and output. In addition, it requires monitoring at a macro level.
Batch Processing	The handling of a batch of many business transactions that have accumulated over a period of time (e.g. an hour, day, week, month, or year). It is the application of a process, or set of processes, to many data entities or objects in a repetitive and predictable fashion with either no manual element, or a separate manual element for error processing.
Batch Window	The time frame within which a batch job must complete. This can be constrained by other systems coming online, other dependent jobs needing to execute or other factors specific to the batch environment.
Step	It is the main batch task or unit of work controller. It initializes the business logic, and controls the transaction environment based on commit interval setting, etc.
Tasklet	A component created by application developer to process the business logic for a Step.
Batch Job Type	Job Types describe application of jobs for particular type of processing. Common areas are interface processing (typically flat files), forms processing (either for online pdf generation or print formats), report processing.
Driving Query	A driving query identifies the set of work for a job to do; the job then breaks that work into individual units of work. For instance, identify all financial transactions that have a status of "pending transmission" and send them to our partner system. The driving query returns a set of record IDs to process; each record ID then becomes a unit of work. A driving query may involve a join (if the criteria for selection falls across two or more tables) or it may work with a single table.
Item	An item represents the smallest amount of complete data for processing. In the simplest terms, this might mean a line in a file, a row in a database table, or a particular element in an XML file.
Logical Unit of Work (LUW)	A batch job iterates through a driving query (or another input source such as a file) to perform the set of work that the job must accomplish. Each iteration of work performed is a unit of work.
Commit Interval	A set of LUWs processed within a single transaction.

Partitioning	Splitting a job into multiple threads where each thread is responsible for a subset of the overall data to be processed. The threads of execution may be within the same JVM or they may span JVMs in a clustered environment that supports workload balancing.
Staging Table	A table that holds temporary data while it is being processed.
Restartable	A job that can be executed again and will assume the same identity as when run initially. In othewords, it is has the same job instance id.
Rerunnable	A job that is restartable and manages its own state in terms of previous run's record processing. An example of a rerunnable step is one based on a driving query. If the driving query can be formed so that it will limit the processed rows when the job is restarted than it is re-runnable. This is managed by the application logic. Often times a condition is added to the where statement to limit the rows returned by the driving query with something like "and processedFlag != true".
Repeat	One of the most basic units of batch processing, that defines repeatability calling a portion of code until it is finished, and while there is no error. Typically a batch process would be repeatable as long as there is input.
Retry	Simplifies the execution of operations with retry semantics most frequently associated with handling transactional output exceptions. Retry is slightly different from repeat, rather than continually calling a block of code, retry is stateful, and continually calls the same block of code with the same input, until it either succeeds, or some type of retry limit has been exceeded. It is only generally useful if a subsequent invocation of the operation might succeed because something in the environment has improved.
Recover	Recover operations handle an exception in such a way that a repeat process is able to continue.
Skip	Skip is a recovery strategy often used on file input sources as the strategy for ignoring bad input records that failed validation.