

Spring Batch - Reference Documentation

Version 4.2.5.RELEASE

Table of Contents

1. Spring Batch Introduction	1
1.1. Background	1
1.2. Usage Scenarios	2
1.3. Spring Batch Architecture	3
1.4. General Batch Principles and Guidelines	4
1.5. Batch Processing Strategies	4
2. What's New in Spring Batch 4.2	12
2.1. Batch metrics with Micrometer	12
2.2. Apache Kafka item reader/writer	12
2.3. Apache Avro item reader/writer	12
2.4. Documentation updates	12
3. The Domain Language of Batch	13
3.1. Job	13
3.1.1. JobInstance	15
3.1.2. JobParameters	15
3.1.3. JobExecution	16
3.2. Step	18
3.2.1. StepExecution	19
3.3. ExecutionContext	20
3.4. JobRepository	22
3.5. JobLauncher	22
3.6. Item Reader	22
3.7. Item Writer	23
3.8. Item Processor	23
3.9. Batch Namespace	23
4. Configuring and Running a Job	24
4.1. Configuring a Job	24
4.1.1. Restartability	25
4.1.2. Intercepting Job Execution	26
4.1.3. Inheriting from a Parent Job	27
4.1.4. JobParametersValidator	28
4.2. Java Config	29
4.3. Configuring a JobRepository	30
4.3.1. Transaction Configuration for the JobRepository	31
4.3.2. Changing the Table Prefix	33
4.3.3. In-Memory Repository	33
4.3.4. Non-standard Database Types in a Repository	34
4.4. Configuring a JobLauncher	35

4.5. Running a Job	37
4.5.1. Running Jobs from the Command Line	37
The CommandLineJobRunner	37
ExitCodes	39
4.5.2. Running Jobs from within a Web Container	40
4.6. Advanced Meta-Data Usage	41
4.6.1. Querying the Repository	42
4.6.2. JobRegistry	43
JobRegistryBeanPostProcessor	44
AutomaticJobRegistrar	44
4.6.3. JobOperator	46
4.6.4. JobParametersIncrementer	47
4.6.5. Stopping a Job	49
4.6.6. Aborting a Job	49
5. Configuring a Step	50
5.1. Chunk-oriented Processing	50
5.1.1. Configuring a Step	51
5.1.2. Inheriting from a Parent Step	53
Abstract Step	53
Merging Lists	54
5.1.3. The Commit Interval	54
5.1.4. Configuring a Step for Restart	55
Setting a Start Limit	55
Restarting a Completed Step	56
Step Restart Configuration Example	57
5.1.5. Configuring Skip Logic	59
5.1.6. Configuring Retry Logic	61
5.1.7. Controlling Rollback	62
Transactional Readers	63
5.1.8. Transaction Attributes	63
5.1.9. Registering ItemStream with a Step	64
5.1.10. Intercepting Step Execution	66
StepExecutionListener	67
ChunkListener	68
ItemReadListener	68
ItemProcessListener	69
ItemWriteListener	70
SkipListener	70
5.2. TaskletStep	71
5.2.1. TaskletAdapter	72
5.2.2. Example Tasklet Implementation	72
5.3. Controlling Step Flow	74

5.3.1. Sequential Flow	74
5.3.2. Conditional Flow	76
Batch Status Versus Exit Status	78
5.3.3. Configuring for Stop	80
Ending at a Step	81
Failing a Step	81
Stopping a Job at a Given Step	82
5.3.4. Programmatic Flow Decisions	83
5.3.5. Split Flows	84
5.3.6. Externalizing Flow Definitions and Dependencies Between Jobs	85
5.4. Late Binding of Job and Step Attributes	88
5.4.1. Step Scope	90
5.4.2. Job Scope	91
6. ItemReaders and ItemWriters	94
6.1. ItemReader	94
6.2. ItemWriter	95
6.3. ItemProcessor	95
6.3.1. Chaining ItemProcessors	98
6.3.2. Filtering Records	101
6.3.3. Fault Tolerance	102
6.4. ItemStream	102
6.5. The Delegate Pattern and Registering with the Step	102
6.6. Flat Files	104
6.6.1. The FieldSet	104
6.6.2. FlatFileItemReader	105
LineMapper	106
LineTokenizer	107
FieldSetMapper	107
DefaultLineMapper	107
Simple Delimited File Reading Example	108
Mapping Fields by Name	110
Automapping FieldSets to Domain Objects	111
Fixed Length File Formats	111
Multiple Record Types within a Single File	113
Exception Handling in Flat Files	115
6.6.3. FlatFileItemWriter	117
LineAggregator	117
Simplified File Writing Example	117
FieldExtractor	118
Delimited File Writing Example	120
Fixed Width File Writing Example	121
Handling File Creation	123

6.7. XML Item Readers and Writers	123
6.7.1. StaxEventItemReader	125
6.7.2. StaxEventItemWriter	128
6.8. JSON Item Readers And Writers	131
6.8.1. JsonItemReader	132
6.8.2. JsonFileItemWriter	133
6.9. Multi-File Input	133
6.10. Database	134
6.10.1. Cursor-based ItemReader Implementations	134
JdbcCursorItemReader	135
HibernateCursorItemReader	138
StoredProcedureItemReader	140
6.10.2. Paging ItemReader Implementations	144
JdbcPagingItemReader	144
JpaPagingItemReader	146
6.10.3. Database ItemWriters	147
6.11. Reusing Existing Services	149
6.12. Validating Input	150
6.13. Preventing State Persistence	152
6.14. Creating Custom ItemReaders and ItemWriters	153
6.14.1. Custom ItemReader Example	154
Making the ItemReader Restartable	154
6.14.2. Custom ItemWriter Example	156
Making the ItemWriter Restartable	157
6.15. Item Reader and Writer Implementations	157
6.15.1. Decorators	157
SynchronizedItemStreamReader	157
SingleItemPeekableItemReader	157
MultiResourceItemWriter	158
ClassifierCompositeItemWriter	158
ClassifierCompositeItemProcessor	158
6.15.2. Messaging Readers And Writers	158
AmqpItemReader	158
AmqpItemWriter	158
JmsItemReader	159
JmsItemWriter	159
KafkaItemReader	159
KafkaItemWriter	159
6.15.3. Database Readers	159
Neo4jItemReader	159
MongoItemReader	159
HibernateCursorItemReader	159
HibernatePagingItemReader	160
RepositoryItemReader	160
6.15.4. Database Writers	160

Neo4jItemWriter	160
MongoItemWriter	160
RepositoryItemWriter	160
HibernateItemWriter	160
JdbcBatchItemWriter	161
JpaItemWriter	161
GemfireItemWriter	161
6.15.5. Specialized Readers	161
LdifReader	161
MappingLdifReader	161
AvroItemReader	161
6.15.6. Specialized Writers	161
SimpleMailMessageItemWriter	162
AvroItemWriter	162
6.15.7. Specialized Processors	162
ScriptItemProcessor	162
7. Scaling and Parallel Processing	163
7.1. Multi-threaded Step	163
7.2. Parallel Steps	165
7.3. Remote Chunking	167
7.4. Partitioning	168
7.4.1. PartitionHandler	170
7.4.2. Partitioner	171
7.4.3. Binding Input Data to Steps	172
8. Repeat	174
8.1. RepeatTemplate	174
8.1.1. RepeatContext	175
8.1.2. RepeatStatus	175
8.2. Completion Policies	176
8.3. Exception Handling	176
8.4. Listeners	176
8.5. Parallel Processing	177
8.6. Declarative Iteration	177
9. Retry	179
9.1. RetryTemplate	179
9.1.1. RetryContext	180
9.1.2. RecoveryCallback	180
9.1.3. Stateless Retry	181
9.1.4. Stateful Retry	181
9.2. Retry Policies	182
9.3. Backoff Policies	183
9.4. Listeners	183
9.5. Declarative Retry	184

10. Unit Testing	186
10.1. Creating a Unit Test Class	186
10.2. End-To-End Testing of Batch Jobs	186
10.3. Testing Individual Steps	188
10.4. Testing Step-Scoped Components	188
10.5. Validating Output Files	190
10.6. Mocking Domain Objects	191
11. Common Batch Patterns	193
11.1. Logging Item Processing and Failures	193
11.2. Stopping a Job Manually for Business Reasons	194
11.3. Adding a Footer Record	196
11.3.1. Writing a Summary Footer	197
11.4. Driving Query Based ItemReaders	199
11.5. Multi-Line Records	200
11.6. Executing System Commands	204
11.7. Handling Step Completion When No Input is Found	205
11.8. Passing Data to Future Steps	205
12. JSR-352 Support	209
12.1. General Notes about Spring Batch and JSR-352	209
12.2. Setup	209
12.2.1. Application Contexts	209
12.2.2. Launching a JSR-352 based job	209
12.3. Dependency Injection	211
12.4. Batch Properties	212
12.4.1. Property Support	212
12.4.2. @BatchProperty annotation	213
12.4.3. Property Substitution	213
12.5. Processing Models	214
12.5.1. Item based processing	214
12.5.2. Custom checkpointing	214
12.6. Running a job	215
12.7. Contexts	215
12.8. Step Flow	216
12.9. Scaling a JSR-352 batch job	216
12.9.1. Partitioning	217
12.10. Testing	218
13. Spring Batch Integration	219
13.1. Spring Batch Integration Introduction	219
13.1.1. Namespace Support	219
13.1.2. Launching Batch Jobs through Messages	220
Transforming a file into a JobLaunchRequest	221

The JobExecution Response	222
Spring Batch Integration Configuration	223
Example ItemReader Configuration	224
13.2. Available Attributes of the Job-Launching Gateway	225
13.3. Sub-Elements	226
13.3.1. Providing Feedback with Informational Messages	226
13.3.2. Asynchronous Processors	228
13.3.3. Externalizing Batch Process Execution	229
Remote Chunking	230
Remote Partitioning	238
14. Monitoring and metrics	245
14.1. Built-in metrics	245
14.2. Custom metrics	245
Appendix A: List of ItemReaders and ItemWriters	247
A.1. Item Readers	247
A.2. Item Writers	248
Appendix B: Meta-Data Schema	251
B.1. Overview	251
B.1.1. Example DDL Scripts	251
B.1.2. Migration DDL Scripts	251
B.1.3. Version	252
B.1.4. Identity	252
B.2. BATCH_JOB_INSTANCE	252
B.3. BATCH_JOB_EXECUTION_PARAMS	253
B.4. BATCH_JOB_EXECUTION	254
B.5. BATCH_STEP_EXECUTION	255
B.6. BATCH_JOB_EXECUTION_CONTEXT	256
B.7. BATCH_STEP_EXECUTION_CONTEXT	257
B.8. Archiving	257
B.9. International and Multi-byte Characters	258
B.10. Recommendations for Indexing Meta Data Tables	258
Appendix C: Batch Processing and Transactions	259
C.1. Simple Batching with No Retry	259
C.2. Simple Stateless Retry	259
C.3. Typical Repeat-Retry Pattern	260
C.4. Asynchronous Chunk Processing	261
C.5. Asynchronous Item Processing	261
C.6. Interactions Between Batching and Transaction Propagation	262
C.7. Special Case: Transactions with Orthogonal Resources	263
C.8. Stateless Retry Cannot Recover	264
Appendix D: Glossary	266

Chapter 1. Spring Batch Introduction

Many applications within the enterprise domain require bulk processing to perform business operations in mission critical environments. These business operations include:

- Automated, complex processing of large volumes of information that is most efficiently processed without user interaction. These operations typically include time-based events (such as month-end calculations, notices, or correspondence).
- Periodic application of complex business rules processed repetitively across very large data sets (for example, insurance benefit determination or rate adjustments).
- Integration of information that is received from internal and external systems that typically requires formatting, validation, and processing in a transactional manner into the system of record. Batch processing is used to process billions of transactions every day for enterprises.

Spring Batch is a lightweight, comprehensive batch framework designed to enable the development of robust batch applications vital for the daily operations of enterprise systems. Spring Batch builds upon the characteristics of the Spring Framework that people have come to expect (productivity, POJO-based development approach, and general ease of use), while making it easy for developers to access and leverage more advanced enterprise services when necessary. Spring Batch is not a scheduling framework. There are many good enterprise schedulers (such as Quartz, Tivoli, Control-M, etc.) available in both the commercial and open source spaces. It is intended to work in conjunction with a scheduler, not replace a scheduler.

Spring Batch provides reusable functions that are essential in processing large volumes of records, including logging/tracing, transaction management, job processing statistics, job restart, skip, and resource management. It also provides more advanced technical services and features that enable extremely high-volume and high performance batch jobs through optimization and partitioning techniques. Spring Batch can be used in both simple use cases (such as reading a file into a database or running a stored procedure) as well as complex, high volume use cases (such as moving high volumes of data between databases, transforming it, and so on). High-volume batch jobs can leverage the framework in a highly scalable manner to process significant volumes of information.

1.1. Background

While open source software projects and associated communities have focused greater attention on web-based and microservices-based architecture frameworks, there has been a notable lack of focus on reusable architecture frameworks to accommodate Java-based batch processing needs, despite continued needs to handle such processing within enterprise IT environments. The lack of a standard, reusable batch architecture has resulted in the proliferation of many one-off, in-house solutions developed within client enterprise IT functions.

SpringSource (now Pivotal) and Accenture collaborated to change this. Accenture's hands-on industry and technical experience in implementing batch architectures, SpringSource's depth of technical experience, and Spring's proven programming model together made a natural and powerful partnership to create high-quality, market-relevant software aimed at filling an important gap in enterprise Java. Both companies worked with a number of clients who were solving similar problems by developing Spring-based batch architecture solutions. This provided some useful

additional detail and real-life constraints that helped to ensure the solution can be applied to the real-world problems posed by clients.

Accenture contributed previously proprietary batch processing architecture frameworks to the Spring Batch project, along with committer resources to drive support, enhancements, and the existing feature set. Accenture's contribution was based upon decades of experience in building batch architectures with the last several generations of platforms: COBOL/Mainframe, C++/Unix, and now Java/anywhere.

The collaborative effort between Accenture and SpringSource aimed to promote the standardization of software processing approaches, frameworks, and tools that can be consistently leveraged by enterprise users when creating batch applications. Companies and government agencies desiring to deliver standard, proven solutions to their enterprise IT environments can benefit from Spring Batch.

1.2. Usage Scenarios

A typical batch program generally:

- Reads a large number of records from a database, file, or queue.
- Processes the data in some fashion.
- Writes back data in a modified form.

Spring Batch automates this basic batch iteration, providing the capability to process similar transactions as a set, typically in an offline environment without any user interaction. Batch jobs are part of most IT projects, and Spring Batch is the only open source framework that provides a robust, enterprise-scale solution.

Business Scenarios

- Commit batch process periodically
- Concurrent batch processing: parallel processing of a job
- Staged, enterprise message-driven processing
- Massively parallel batch processing
- Manual or scheduled restart after failure
- Sequential processing of dependent steps (with extensions to workflow-driven batches)
- Partial processing: skip records (for example, on rollback)
- Whole-batch transaction, for cases with a small batch size or existing stored procedures/scripts

Technical Objectives

- Batch developers use the Spring programming model: Concentrate on business logic and let the framework take care of infrastructure.
- Clear separation of concerns between the infrastructure, the batch execution environment, and the batch application.

- Provide common, core execution services as interfaces that all projects can implement.
- Provide simple and default implementations of the core execution interfaces that can be used 'out of the box'.
- Easy to configure, customize, and extend services, by leveraging the spring framework in all layers.
- All existing core services should be easy to replace or extend, without any impact to the infrastructure layer.
- Provide a simple deployment model, with the architecture JARs completely separate from the application, built using Maven.

1.3. Spring Batch Architecture

Spring Batch is designed with extensibility and a diverse group of end users in mind. The figure below shows the layered architecture that supports the extensibility and ease of use for end-user developers.

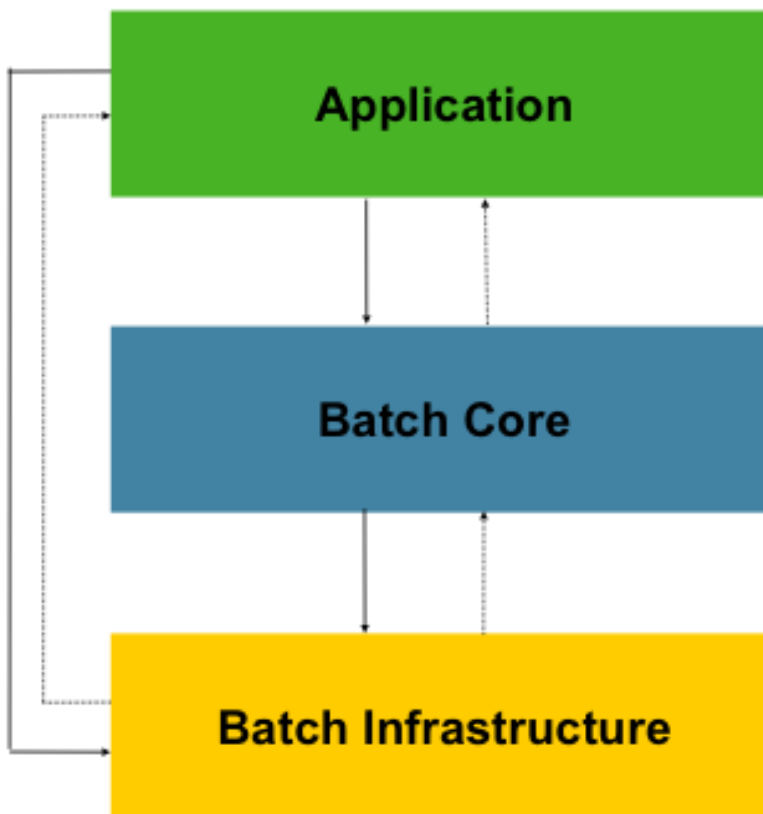

Figure 1. Spring Batch Layered Architecture

This layered architecture highlights three major high-level components: Application, Core, and Infrastructure. The application contains all batch jobs and custom code written by developers using Spring Batch. The Batch Core contains the core runtime classes necessary to launch and control a batch job. It includes implementations for `JobLauncher`, `Job`, and `Step`. Both Application and Core are built on top of a common infrastructure. This infrastructure contains common readers and writers and services (such as the `RetryTemplate`), which are used both by application developers (readers and writers, such as `ItemReader` and `ItemWriter`) and the core framework itself (retry, which is its own library).

1.4. General Batch Principles and Guidelines

The following key principles, guidelines, and general considerations should be considered when building a batch solution.

- Remember that a batch architecture typically affects on-line architecture and vice versa. Design with both architectures and environments in mind using common building blocks when possible.
- Simplify as much as possible and avoid building complex logical structures in single batch applications.
- Keep the processing and storage of data physically close together (in other words, keep your data where your processing occurs).
- Minimize system resource use, especially I/O. Perform as many operations as possible in internal memory.
- Review application I/O (analyze SQL statements) to ensure that unnecessary physical I/O is avoided. In particular, the following four common flaws need to be looked for:
 - Reading data for every transaction when the data could be read once and cached or kept in the working storage.
 - Rereading data for a transaction where the data was read earlier in the same transaction.
 - Causing unnecessary table or index scans.
 - Not specifying key values in the WHERE clause of an SQL statement.
- Do not do things twice in a batch run. For instance, if you need data summarization for reporting purposes, you should (if possible) increment stored totals when data is being initially processed, so your reporting application does not have to reprocess the same data.
- Allocate enough memory at the beginning of a batch application to avoid time-consuming reallocation during the process.
- Always assume the worst with regard to data integrity. Insert adequate checks and record validation to maintain data integrity.
- Implement checksums for internal validation where possible. For example, flat files should have a trailer record telling the total of records in the file and an aggregate of the key fields.
- Plan and execute stress tests as early as possible in a production-like environment with realistic data volumes.
- In large batch systems, backups can be challenging, especially if the system is running concurrent with on-line on a 24-7 basis. Database backups are typically well taken care of in the on-line design, but file backups should be considered to be just as important. If the system depends on flat files, file backup procedures should not only be in place and documented but be regularly tested as well.

1.5. Batch Processing Strategies

To help design and implement batch systems, basic batch application building blocks and patterns should be provided to the designers and programmers in the form of sample structure charts and

code shells. When starting to design a batch job, the business logic should be decomposed into a series of steps that can be implemented using the following standard building blocks:

- *Conversion Applications:* For each type of file supplied by or generated to an external system, a conversion application must be created to convert the transaction records supplied into a standard format required for processing. This type of batch application can partly or entirely consist of translation utility modules (see Basic Batch Services).
- *Validation Applications:* Validation applications ensure that all input/output records are correct and consistent. Validation is typically based on file headers and trailers, checksums and validation algorithms, and record level cross-checks.
- *Extract Applications:* An application that reads a set of records from a database or input file, selects records based on predefined rules, and writes the records to an output file.
- *Extract/Update Applications:* An application that reads records from a database or an input file and makes changes to a database or an output file driven by the data found in each input record.
- *Processing and Updating Applications:* An application that performs processing on input transactions from an extract or a validation application. The processing usually involves reading a database to obtain data required for processing, potentially updating the database and creating records for output processing.
- *Output/Format Applications:* Applications that read an input file, restructure data from this record according to a standard format, and produce an output file for printing or transmission to another program or system.

Additionally, a basic application shell should be provided for business logic that cannot be built using the previously mentioned building blocks.

In addition to the main building blocks, each application may use one or more of standard utility steps, such as:

- *Sort:* A program that reads an input file and produces an output file where records have been re-sequenced according to a sort key field in the records. Sorts are usually performed by standard system utilities.
- *Split:* A program that reads a single input file and writes each record to one of several output files based on a field value. Splits can be tailored or performed by parameter-driven standard system utilities.
- *Merge:* A program that reads records from multiple input files and produces one output file with combined data from the input files. Merges can be tailored or performed by parameter-driven standard system utilities.

Batch applications can additionally be categorized by their input source:

- Database-driven applications are driven by rows or values retrieved from the database.
- File-driven applications are driven by records or values retrieved from a file.
- Message-driven applications are driven by messages retrieved from a message queue.

The foundation of any batch system is the processing strategy. Factors affecting the selection of the

strategy include: estimated batch system volume, concurrency with on-line systems or with other batch systems, available batch windows. (Note that, with more enterprises wanting to be up and running 24x7, clear batch windows are disappearing).

Typical processing options for batch are (in increasing order of implementation complexity):

- Normal processing during a batch window in off-line mode.
- Concurrent batch or on-line processing.
- Parallel processing of many different batch runs or jobs at the same time.
- Partitioning (processing of many instances of the same job at the same time).
- A combination of the preceding options.

Some or all of these options may be supported by a commercial scheduler.

The following section discusses these processing options in more detail. It is important to notice that, as a rule of thumb, the commit and locking strategy adopted by batch processes depends on the type of processing performed and that the on-line locking strategy should also use the same principles. Therefore, the batch architecture cannot be simply an afterthought when designing an overall architecture.

The locking strategy can be to use only normal database locks or to implement an additional custom locking service in the architecture. The locking service would track database locking (for example, by storing the necessary information in a dedicated db-table) and give or deny permissions to the application programs requesting a db operation. Retry logic could also be implemented by this architecture to avoid aborting a batch job in case of a lock situation.

1. Normal processing in a batch window For simple batch processes running in a separate batch window where the data being updated is not required by on-line users or other batch processes, concurrency is not an issue and a single commit can be done at the end of the batch run.

In most cases, a more robust approach is more appropriate. Keep in mind that batch systems have a tendency to grow as time goes by, both in terms of complexity and the data volumes they handle. If no locking strategy is in place and the system still relies on a single commit point, modifying the batch programs can be painful. Therefore, even with the simplest batch systems, consider the need for commit logic for restart-recovery options as well as the information concerning the more complex cases described later in this section.

2. Concurrent batch or on-line processing Batch applications processing data that can be simultaneously updated by on-line users should not lock any data (either in the database or in files) which could be required by on-line users for more than a few seconds. Also, updates should be committed to the database at the end of every few transactions. This minimizes the portion of data that is unavailable to other processes and the elapsed time the data is unavailable.

Another option to minimize physical locking is to have logical row-level locking implemented with either an Optimistic Locking Pattern or a Pessimistic Locking Pattern.

- Optimistic locking assumes a low likelihood of record contention. It typically means inserting a timestamp column in each database table used concurrently by both batch and on-line

processing. When an application fetches a row for processing, it also fetches the timestamp. As the application then tries to update the processed row, the update uses the original timestamp in the WHERE clause. If the timestamp matches, the data and the timestamp are updated. If the timestamp does not match, this indicates that another application has updated the same row between the fetch and the update attempt. Therefore, the update cannot be performed.

- Pessimistic locking is any locking strategy that assumes there is a high likelihood of record contention and therefore either a physical or logical lock needs to be obtained at retrieval time. One type of pessimistic logical locking uses a dedicated lock-column in the database table. When an application retrieves the row for update, it sets a flag in the lock column. With the flag in place, other applications attempting to retrieve the same row logically fail. When the application that sets the flag updates the row, it also clears the flag, enabling the row to be retrieved by other applications. Please note that the integrity of data must be maintained also between the initial fetch and the setting of the flag, for example by using db locks (such as **SELECT FOR UPDATE**). Note also that this method suffers from the same downside as physical locking except that it is somewhat easier to manage building a time-out mechanism that gets the lock released if the user goes to lunch while the record is locked.

These patterns are not necessarily suitable for batch processing, but they might be used for concurrent batch and on-line processing (such as in cases where the database does not support row-level locking). As a general rule, optimistic locking is more suitable for on-line applications, while pessimistic locking is more suitable for batch applications. Whenever logical locking is used, the same scheme must be used for all applications accessing data entities protected by logical locks.

Note that both of these solutions only address locking a single record. Often, we may need to lock a logically related group of records. With physical locks, you have to manage these very carefully in order to avoid potential deadlocks. With logical locks, it is usually best to build a logical lock manager that understands the logical record groups you want to protect and that can ensure that locks are coherent and non-deadlocking. This logical lock manager usually uses its own tables for lock management, contention reporting, time-out mechanism, and other concerns.

3. Parallel Processing Parallel processing allows multiple batch runs or jobs to run in parallel to minimize the total elapsed batch processing time. This is not a problem as long as the jobs are not sharing the same files, db-tables, or index spaces. If they do, this service should be implemented using partitioned data. Another option is to build an architecture module for maintaining interdependencies by using a control table. A control table should contain a row for each shared resource and whether it is in use by an application or not. The batch architecture or the application in a parallel job would then retrieve information from that table to determine if it can get access to the resource it needs or not.

If the data access is not a problem, parallel processing can be implemented through the use of additional threads to process in parallel. In the mainframe environment, parallel job classes have traditionally been used, in order to ensure adequate CPU time for all the processes. Regardless, the solution has to be robust enough to ensure time slices for all the running processes.

Other key issues in parallel processing include load balancing and the availability of general system resources such as files, database buffer pools, and so on. Also note that the control table itself can easily become a critical resource.

4. Partitioning Using partitioning allows multiple versions of large batch applications to run

concurrently. The purpose of this is to reduce the elapsed time required to process long batch jobs. Processes that can be successfully partitioned are those where the input file can be split and/or the main database tables partitioned to allow the application to run against different sets of data.

In addition, processes which are partitioned must be designed to only process their assigned data set. A partitioning architecture has to be closely tied to the database design and the database partitioning strategy. Note that database partitioning does not necessarily mean physical partitioning of the database, although in most cases this is advisable. The following picture illustrates the partitioning approach:

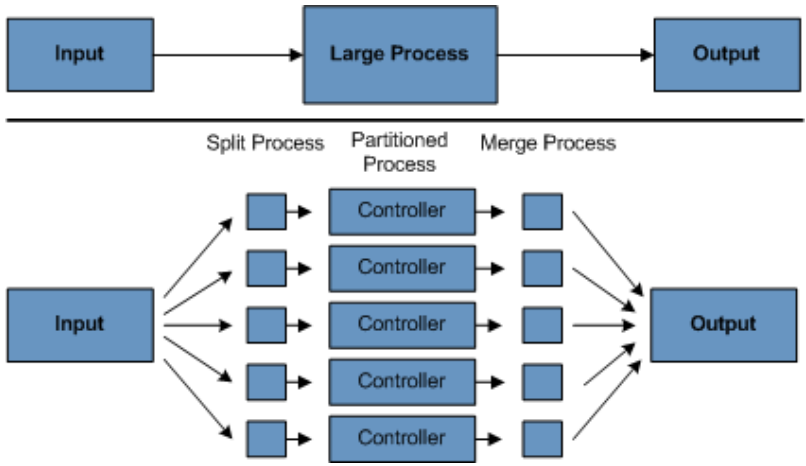

Figure 2. Partitioned Process

The architecture should be flexible enough to allow dynamic configuration of the number of partitions. Both automatic and user controlled configuration should be considered. Automatic configuration may be based on parameters such as the input file size and the number of input records.

4.1 Partitioning Approaches Selecting a partitioning approach has to be done on a case-by-case basis. The following list describes some of the possible partitioning approaches:

1. Fixed and Even Break-Up of Record Set

This involves breaking the input record set into an even number of portions (for example, 10, where each portion has exactly 1/10th of the entire record set). Each portion is then processed by one instance of the batch/extract application.

In order to use this approach, preprocessing is required to split the recordset up. The result of this split will be a lower and upper bound placement number which can be used as input to the batch/extract application in order to restrict its processing to only its portion.

Preprocessing could be a large overhead, as it has to calculate and determine the bounds of each portion of the record set.

2. Break up by a Key Column

This involves breaking up the input record set by a key column, such as a location code, and assigning data from each key to a batch instance. In order to achieve this, column values can be either:

- Assigned to a batch instance by a partitioning table (described later in this section).
- Assigned to a batch instance by a portion of the value (such as 0000-0999, 1000 - 1999, and so on).

Under option 1, adding new values means a manual reconfiguration of the batch/extract to ensure that the new value is added to a particular instance.

Under option 2, this ensures that all values are covered via an instance of the batch job. However, the number of values processed by one instance is dependent on the distribution of column values (there may be a large number of locations in the 0000-0999 range, and few in the 1000-1999 range). Under this option, the data range should be designed with partitioning in mind.

Under both options, the optimal even distribution of records to batch instances cannot be realized. There is no dynamic configuration of the number of batch instances used.

3. Breakup by Views

This approach is basically breakup by a key column but on the database level. It involves breaking up the recordset into views. These views are used by each instance of the batch application during its processing. The breakup is done by grouping the data.

With this option, each instance of a batch application has to be configured to hit a particular view (instead of the master table). Also, with the addition of new data values, this new group of data has to be included into a view. There is no dynamic configuration capability, as a change in the number of instances results in a change to the views.

4. Addition of a Processing Indicator

This involves the addition of a new column to the input table, which acts as an indicator. As a preprocessing step, all indicators are marked as being non-processed. During the record fetch stage of the batch application, records are read on the condition that that record is marked as being non-processed, and once they are read (with lock), they are marked as being in processing. When that record is completed, the indicator is updated to either complete or error. Many instances of a batch application can be started without a change, as the additional column ensures that a record is only processed once. sentence or two on the order of "On completion, indicators are marked as being complete.")

With this option, I/O on the table increases dynamically. In the case of an updating batch application, this impact is reduced, as a write must occur anyway.

5. Extract Table to a Flat File

This involves the extraction of the table into a file. This file can then be split into multiple segments and used as input to the batch instances.

With this option, the additional overhead of extracting the table into a file and splitting it may cancel out the effect of multi-partitioning. Dynamic configuration can be achieved by changing the file splitting script.

6. Use of a Hashing Column

This scheme involves the addition of a hash column (key/index) to the database tables used to retrieve the driver record. This hash column has an indicator to determine which instance of the batch application processes this particular row. For example, if there are three batch instances to be started, then an indicator of 'A' marks a row for processing by instance 1, an indicator of 'B' marks a row for processing by instance 2, and an indicator of 'C' marks a row for processing by instance 3.

The procedure used to retrieve the records would then have an additional **WHERE** clause to select all rows marked by a particular indicator. The inserts in this table would involve the addition of the marker field, which would be defaulted to one of the instances (such as 'A').

A simple batch application would be used to update the indicators, such as to redistribute the load between the different instances. When a sufficiently large number of new rows have been added, this batch can be run (anytime, except in the batch window) to redistribute the new rows to other instances.

Additional instances of the batch application only require the running of the batch application as described in the preceding paragraphs to redistribute the indicators to work with a new number of instances.

4.2 Database and Application Design Principles

An architecture that supports multi-partitioned applications which run against partitioned database tables using the key column approach should include a central partition repository for storing partition parameters. This provides flexibility and ensures maintainability. The repository generally consists of a single table, known as the partition table.

Information stored in the partition table is static and, in general, should be maintained by the DBA. The table should consist of one row of information for each partition of a multi-partitioned application. The table should have columns for Program ID Code, Partition Number (logical ID of the partition), Low Value of the db key column for this partition, and High Value of the db key column for this partition.

On program start-up, the program **id** and partition number should be passed to the application from the architecture (specifically, from the Control Processing Tasklet). If a key column approach is used, these variables are used to read the partition table in order to determine what range of data the application is to process. In addition the partition number must be used throughout the processing to:

- Add to the output files/database updates in order for the merge process to work properly.
- Report normal processing to the batch log and any errors to the architecture error handler.

4.3 Minimizing Deadlocks

When applications run in parallel or are partitioned, contention in database resources and deadlocks may occur. It is critical that the database design team eliminates potential contention situations as much as possible as part of the database design.

Also, the developers must ensure that the database index tables are designed with deadlock prevention and performance in mind.

Deadlocks or hot spots often occur in administration or architecture tables, such as log tables, control tables, and lock tables. The implications of these should be taken into account as well. A realistic stress test is crucial for identifying the possible bottlenecks in the architecture.

To minimize the impact of conflicts on data, the architecture should provide services such as wait-and-retry intervals when attaching to a database or when encountering a deadlock. This means a built-in mechanism to react to certain database return codes and, instead of issuing an immediate error, waiting a predetermined amount of time and retrying the database operation.

4.4 Parameter Passing and Validation

The partition architecture should be relatively transparent to application developers. The architecture should perform all tasks associated with running the application in a partitioned mode, including:

- Retrieving partition parameters before application start-up.
- Validating partition parameters before application start-up.
- Passing parameters to the application at start-up.

The validation should include checks to ensure that:

- The application has sufficient partitions to cover the whole data range.
- There are no gaps between partitions.

If the database is partitioned, some additional validation may be necessary to ensure that a single partition does not span database partitions.

Also, the architecture should take into consideration the consolidation of partitions. Key questions include:

- Must all the partitions be finished before going into the next job step?
- What happens if one of the partitions aborts?

Chapter 2. What's New in Spring Batch 4.2

Spring Batch 4.2 adds the following features:

- Support for batch metrics with [Micrometer](#)
- Support for reading/writing data from/to [Apache Kafka](#) topics
- Support for reading/writing data from/to [Apache Avro](#) resources
- Improved documentation

2.1. Batch metrics with Micrometer

This release introduces a new feature that lets you monitor your batch jobs by using Micrometer. By default, Spring Batch collects metrics (such as job duration, step duration, item read and write throughput, and others) and registers them in Micrometer's global metrics registry under the `spring.batch` prefix. These metrics can be sent to any [monitoring system](#) supported by Micrometer.

For more details about this feature, please refer to the [Monitoring and metrics](#) chapter.

2.2. Apache Kafka item reader/writer

This release adds a new `KafkaItemReader` and `KafkaItemWriter` to read data from and write it to Kafka topics. For more details about these new components, please refer to the [Javadoc](#).

2.3. Apache Avro item reader/writer

This release adds a new `AvroItemReader` and `AvroItemWriter` to read data from and write it to Avro resources. For more details about these new components, please refer to the [Javadoc](#).

2.4. Documentation updates

The reference documentation has been updated to match the same style as other Spring projects.

Chapter 3. The Domain Language of Batch

To any experienced batch architect, the overall concepts of batch processing used in Spring Batch should be familiar and comfortable. There are "Jobs" and "Steps" and developer-supplied processing units called `ItemReader` and `ItemWriter`. However, because of the Spring patterns, operations, templates, callbacks, and idioms, there are opportunities for the following:

- Significant improvement in adherence to a clear separation of concerns.
- Clearly delineated architectural layers and services provided as interfaces.
- Simple and default implementations that allow for quick adoption and ease of use out-of-the-box.
- Significantly enhanced extensibility.

The following diagram is a simplified version of the batch reference architecture that has been used for decades. It provides an overview of the components that make up the domain language of batch processing. This architecture framework is a blueprint that has been proven through decades of implementations on the last several generations of platforms (COBOL/Mainframe, C/Unix, and now Java/anywhere). JCL and COBOL developers are likely to be as comfortable with the concepts as C, C#, and Java developers. Spring Batch provides a physical implementation of the layers, components, and technical services commonly found in the robust, maintainable systems that are used to address the creation of simple to complex batch applications, with the infrastructure and extensions to address very complex processing needs.

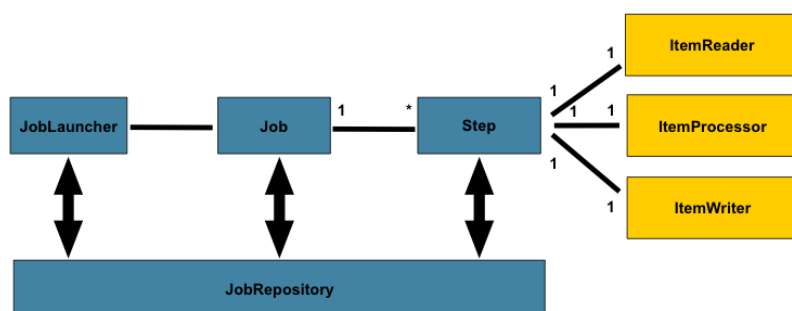

Figure 3. Batch Stereotypes

The preceding diagram highlights the key concepts that make up the domain language of Spring Batch. A `Job` has one to many steps, each of which has exactly one `ItemReader`, one `ItemProcessor`, and one `ItemWriter`. A job needs to be launched (with `JobLauncher`), and metadata about the currently running process needs to be stored (in `JobRepository`).

3.1. Job

This section describes stereotypes relating to the concept of a batch job. A `Job` is an entity that encapsulates an entire batch process. As is common with other Spring projects, a `Job` is wired together with either an XML configuration file or Java-based configuration. This configuration may be referred to as the "job configuration". However, `Job` is just the top of an overall hierarchy, as shown in the following diagram:

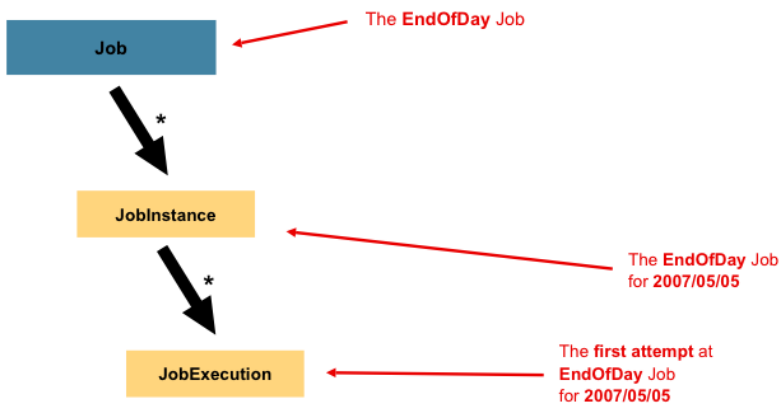

Figure 4. Job Hierarchy

In Spring Batch, a **Job** is simply a container for **Step** instances. It combines multiple steps that belong logically together in a flow and allows for configuration of properties global to all steps, such as restartability. The job configuration contains:

- The simple name of the job.
- Definition and ordering of **Step** instances.
- Whether or not the job is restartable.

A default simple implementation of the Job interface is provided by Spring Batch in the form of the **SimpleJob** class, which creates some standard functionality on top of **Job**. When using java based configuration, a collection of builders are made available for the instantiation of a **Job**, as shown in the following example:

```

@Bean
public Job footballJob() {
    return this.jobBuilderFactory.get("footballJob")
        .start(playerLoad())
        .next(gameLoad())
        .next(playerSummarization())
        .end()
        .build();
}
  
```

However, when using XML configuration, the batch namespace abstracts away the need to instantiate it directly. Instead, the `<job>` tag can be used as shown in the following example:

```

<job id="footballJob">
  <step id="playerload" next="gameLoad"/>
  <step id="gameLoad" next="playerSummarization"/>
  <step id="playerSummarization"/>
</job>
  
```

3.1.1. JobInstance

A **JobInstance** refers to the concept of a logical job run. Consider a batch job that should be run once at the end of the day, such as the 'EndOfDay' **Job** from the preceding diagram. There is one 'EndOfDay' job, but each individual run of the **Job** must be tracked separately. In the case of this job, there is one logical **JobInstance** per day. For example, there is a January 1st run, a January 2nd run, and so on. If the January 1st run fails the first time and is run again the next day, it is still the January 1st run. (Usually, this corresponds with the data it is processing as well, meaning the January 1st run processes data for January 1st). Therefore, each **JobInstance** can have multiple executions (**JobExecution** is discussed in more detail later in this chapter), and only one **JobInstance** corresponding to a particular **Job** and identifying **JobParameters** can run at a given time.

The definition of a **JobInstance** has absolutely no bearing on the data to be loaded. It is entirely up to the **ItemReader** implementation to determine how data is loaded. For example, in the EndOfDay scenario, there may be a column on the data that indicates the 'effective date' or 'schedule date' to which the data belongs. So, the January 1st run would load only data from the 1st, and the January 2nd run would use only data from the 2nd. Because this determination is likely to be a business decision, it is left up to the **ItemReader** to decide. However, using the same **JobInstance** determines whether or not the 'state' (that is, the **ExecutionContext**, which is discussed later in this chapter) from previous executions is used. Using a new **JobInstance** means 'start from the beginning', and using an existing instance generally means 'start from where you left off'.

3.1.2. JobParameters

Having discussed **JobInstance** and how it differs from **Job**, the natural question to ask is: "How is one **JobInstance** distinguished from another?" The answer is: **JobParameters**. A **JobParameters** object holds a set of parameters used to start a batch job. They can be used for identification or even as reference data during the run, as shown in the following image:

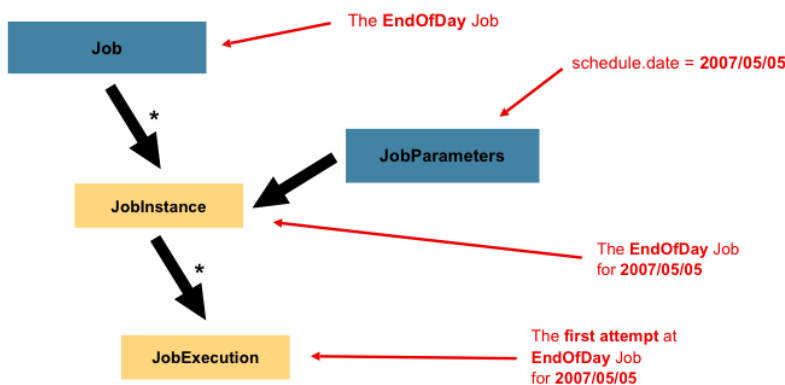

Figure 5. Job Parameters

In the preceding example, where there are two instances, one for January 1st, and another for January 2nd, there is really only one **Job**, but it has two **JobParameter** objects: one that was started with a job parameter of 01-01-2017 and another that was started with a parameter of 01-02-2017. Thus, the contract can be defined as: **JobInstance** = **Job** + identifying **JobParameters**. This allows a developer to effectively control how a **JobInstance** is defined, since they control what parameters are passed in.



Not all job parameters are required to contribute to the identification of a **JobInstance**. By default, they do so. However, the framework also allows the submission of a **Job** with parameters that do not contribute to the identity of a **JobInstance**.

3.1.3. JobExecution

A **JobExecution** refers to the technical concept of a single attempt to run a **Job**. An execution may end in failure or success, but the **JobInstance** corresponding to a given execution is not considered to be complete unless the execution completes successfully. Using the EndOfDay **Job** described previously as an example, consider a **JobInstance** for 01-01-2017 that failed the first time it was run. If it is run again with the same identifying job parameters as the first run (01-01-2017), a new **JobExecution** is created. However, there is still only one **JobInstance**.

A **Job** defines what a job is and how it is to be executed, and a **JobInstance** is a purely organizational object to group executions together, primarily to enable correct restart semantics. A **JobExecution**, however, is the primary storage mechanism for what actually happened during a run and contains many more properties that must be controlled and persisted, as shown in the following table:

Table 1. JobExecution Properties

Property	Definition
Status	A BatchStatus object that indicates the status of the execution. While running, it is BatchStatus#STARTED . If it fails, it is BatchStatus#FAILED . If it finishes successfully, it is BatchStatus#COMPLETED
startTime	A java.util.Date representing the current system time when the execution was started. This field is empty if the job has yet to start.
endTime	A java.util.Date representing the current system time when the execution finished, regardless of whether or not it was successful. The field is empty if the job has yet to finish.
exitStatus	The ExitStatus , indicating the result of the run. It is most important, because it contains an exit code that is returned to the caller. See chapter 5 for more details. The field is empty if the job has yet to finish.
createTime	A java.util.Date representing the current system time when the JobExecution was first persisted. The job may not have been started yet (and thus has no start time), but it always has a createTime , which is required by the framework for managing job level ExecutionContexts .
lastUpdated	A java.util.Date representing the last time a JobExecution was persisted. This field is empty if the job has yet to start.

executionContext	The "property bag" containing any user data that needs to be persisted between executions.
failureExceptions	The list of exceptions encountered during the execution of a Job . These can be useful if more than one exception is encountered during the failure of a Job .

These properties are important because they are persisted and can be used to completely determine the status of an execution. For example, if the EndOfDay job for 01-01 is executed at 9:00 PM and fails at 9:30, the following entries are made in the batch metadata tables:

Table 2. BATCH_JOB_INSTANCE

JOB_INST_ID	JOB_NAME
1	EndOfDayJob

Table 3. BATCH_JOB_EXECUTION_PARAMS

JOB_EXECUTION_ID	TYPE_CD	KEY_NAME	DATE_VAL	IDENTIFYING
1	DATE	schedule.Date	2017-01-01	TRUE

Table 4. BATCH_JOB_EXECUTION

JOB_EXEC_ID	JOB_INST_ID	START_TIME	END_TIME	STATUS
1	1	2017-01-01 21:00	2017-01-01 21:30	FAILED



Column names may have been abbreviated or removed for the sake of clarity and formatting.

Now that the job has failed, assume that it took the entire night for the problem to be determined, so that the 'batch window' is now closed. Further assuming that the window starts at 9:00 PM, the job is kicked off again for 01-01, starting where it left off and completing successfully at 9:30. Because it is now the next day, the 01-02 job must be run as well, and it is kicked off just afterwards at 9:31 and completes in its normal one hour time at 10:30. There is no requirement that one **JobInstance** be kicked off after another, unless there is potential for the two jobs to attempt to access the same data, causing issues with locking at the database level. It is entirely up to the scheduler to determine when a **Job** should be run. Since they are separate **JobInstances**, Spring Batch makes no attempt to stop them from being run concurrently. (Attempting to run the same **JobInstance** while another is already running results in a **JobExecutionAlreadyRunningException** being thrown). There should now be an extra entry in both the **JobInstance** and **JobParameters** tables and two extra entries in the **JobExecution** table, as shown in the following tables:

Table 5. BATCH_JOB_INSTANCE

JOB_INST_ID	JOB_NAME
1	EndOfDayJob
2	EndOfDayJob

Table 6. BATCH_JOB_EXECUTION_PARAMS

JOB_EXECUTION_ID	TYPE_CD	KEY_NAME	DATE_VAL	IDENTIFYING
1	DATE	schedule.Date	2017-01-01 00:00:00	TRUE
2	DATE	schedule.Date	2017-01-01 00:00:00	TRUE
3	DATE	schedule.Date	2017-01-02 00:00:00	TRUE

Table 7. BATCH_JOB_EXECUTION

JOB_EXEC_ID	JOB_INST_ID	START_TIME	END_TIME	STATUS
1	1	2017-01-01 21:00	2017-01-01 21:30	FAILED
2	1	2017-01-02 21:00	2017-01-02 21:30	COMPLETED
3	2	2017-01-02 21:31	2017-01-02 22:29	COMPLETED



Column names may have been abbreviated or removed for the sake of clarity and formatting.

3.2. Step

A **Step** is a domain object that encapsulates an independent, sequential phase of a batch job. Therefore, every Job is composed entirely of one or more steps. A **Step** contains all of the information necessary to define and control the actual batch processing. This is a necessarily vague description because the contents of any given **Step** are at the discretion of the developer writing a **Job**. A **Step** can be as simple or complex as the developer desires. A simple **Step** might load data from a file into the database, requiring little or no code (depending upon the implementations used). A more complex **Step** may have complicated business rules that are applied as part of the processing. As with a **Job**, a **Step** has an individual **StepExecution** that correlates with a unique **JobExecution**, as shown in the following image:

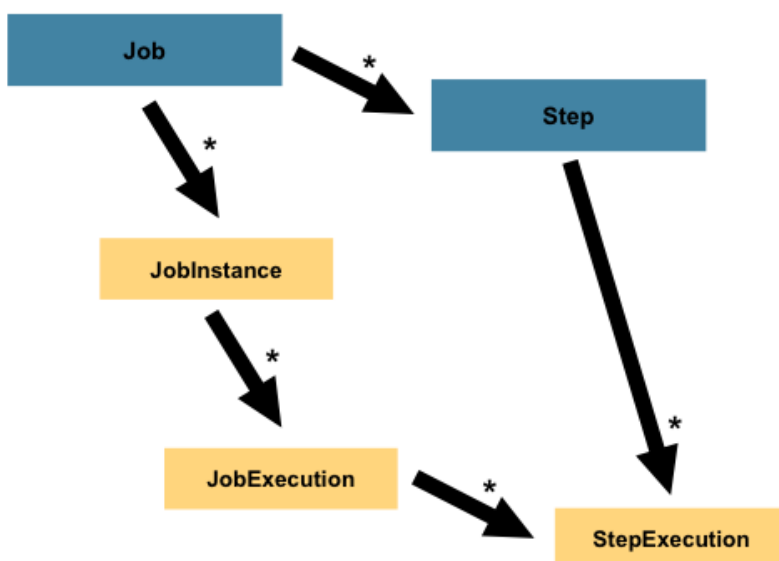

Figure 6. Job Hierarchy With Steps

3.2.1. StepExecution

A `StepExecution` represents a single attempt to execute a `Step`. A new `StepExecution` is created each time a `Step` is run, similar to `JobExecution`. However, if a step fails to execute because the step before it fails, no execution is persisted for it. A `StepExecution` is created only when its `Step` is actually started.

`Step` executions are represented by objects of the `StepExecution` class. Each execution contains a reference to its corresponding step and `JobExecution` and transaction related data, such as commit and rollback counts and start and end times. Additionally, each step execution contains an `ExecutionContext`, which contains any data a developer needs to have persisted across batch runs, such as statistics or state information needed to restart. The following table lists the properties for `StepExecution`:

Table 8. `StepExecution` Properties

Property	Definition
Status	A <code>BatchStatus</code> object that indicates the status of the execution. While running, the status is <code>BatchStatus.STARTED</code> . If it fails, the status is <code>BatchStatus.FAILED</code> . If it finishes successfully, the status is <code>BatchStatus.COMPLETED</code> .
startTime	A <code>java.util.Date</code> representing the current system time when the execution was started. This field is empty if the step has yet to start.
endTime	A <code>java.util.Date</code> representing the current system time when the execution finished, regardless of whether or not it was successful. This field is empty if the step has yet to exit.
exitStatus	The <code>ExitStatus</code> indicating the result of the execution. It is most important, because it contains an exit code that is returned to the caller. See chapter 5 for more details. This field is empty if the job has yet to exit.
executionContext	The "property bag" containing any user data that needs to be persisted between executions.
readCount	The number of items that have been successfully read.
writeCount	The number of items that have been successfully written.
commitCount	The number of transactions that have been committed for this execution.
rollbackCount	The number of times the business transaction controlled by the <code>Step</code> has been rolled back.
readSkipCount	The number of times <code>read</code> has failed, resulting in a skipped item.

processSkipCount	The number of times <code>process</code> has failed, resulting in a skipped item.
filterCount	The number of items that have been 'filtered' by the <code>ItemProcessor</code> .
writeSkipCount	The number of times <code>write</code> has failed, resulting in a skipped item.

3.3. ExecutionContext

An `ExecutionContext` represents a collection of key/value pairs that are persisted and controlled by the framework in order to allow developers a place to store persistent state that is scoped to a `StepExecution` object or a `JobExecution` object. For those familiar with Quartz, it is very similar to `JobDataMap`. The best usage example is to facilitate restart. Using flat file input as an example, while processing individual lines, the framework periodically persists the `ExecutionContext` at commit points. Doing so allows the `ItemReader` to store its state in case a fatal error occurs during the run or even if the power goes out. All that is needed is to put the current number of lines read into the context, as shown in the following example, and the framework will do the rest:

```
executionContext.putLong(getKey(LINES_READ_COUNT), reader.getPosition());
```

Using the `EndOfDay` example from the `Job` Stereotypes section as an example, assume there is one step, 'loadData', that loads a file into the database. After the first failed run, the metadata tables would look like the following example:

Table 9. `BATCH_JOB_INSTANCE`

JOB_INST_ID	JOB_NAME
1	EndOfDayJob

Table 10. `BATCH_JOB_EXECUTION_PARAMS`

JOB_INST_ID	TYPE_CD	KEY_NAME	DATE_VAL
1	DATE	schedule.Date	2017-01-01

Table 11. `BATCH_JOB_EXECUTION`

JOB_EXEC_ID	JOB_INST_ID	START_TIME	END_TIME	STATUS
1	1	2017-01-01 21:00	2017-01-01 21:30	FAILED

Table 12. `BATCH_STEP_EXECUTION`

STEP_EXEC_ID	JOB_EXEC_ID	STEP_NAME	START_TIME	END_TIME	STATUS
1	1	loadData	2017-01-01 21:00	2017-01-01 21:30	FAILED

Table 13. `BATCH_STEP_EXECUTION_CONTEXT`

STEP_EXEC_ID	SHORT_CONTEXT
--------------	---------------

In the preceding case, the **Step** ran for 30 minutes and processed 40,321 'pieces', which would represent lines in a file in this scenario. This value is updated just before each commit by the framework and can contain multiple rows corresponding to entries within the **ExecutionContext**. Being notified before a commit requires one of the various **StepListener** implementations (or an **ItemStream**), which are discussed in more detail later in this guide. As with the previous example, it is assumed that the **Job** is restarted the next day. When it is restarted, the values from the **ExecutionContext** of the last run are reconstituted from the database. When the **ItemReader** is opened, it can check to see if it has any stored state in the context and initialize itself from there, as shown in the following example:

```
if (executionContext.containsKey(getKey(LINES_READ_COUNT))) {
    log.debug("Initializing for restart. Restart data is: " + executionContext);

    long lineCount = executionContext.getLong(getKey(LINES_READ_COUNT));

    LineReader reader = getReader();

    Object record = "";
    while (reader.getPosition() < lineCount && record != null) {
        record = readLine();
    }
}
```

In this case, after the above code runs, the current line is 40,322, allowing the **Step** to start again from where it left off. The **ExecutionContext** can also be used for statistics that need to be persisted about the run itself. For example, if a flat file contains orders for processing that exist across multiple lines, it may be necessary to store how many orders have been processed (which is much different from the number of lines read), so that an email can be sent at the end of the **Step** with the total number of orders processed in the body. The framework handles storing this for the developer, in order to correctly scope it with an individual **JobInstance**. It can be very difficult to know whether an existing **ExecutionContext** should be used or not. For example, using the 'EndOfDay' example from above, when the 01-01 run starts again for the second time, the framework recognizes that it is the same **JobInstance** and on an individual **Step** basis, pulls the **ExecutionContext** out of the database, and hands it (as part of the **StepExecution**) to the **Step** itself. Conversely, for the 01-02 run, the framework recognizes that it is a different instance, so an empty context must be handed to the **Step**. There are many of these types of determinations that the framework makes for the developer, to ensure the state is given to them at the correct time. It is also important to note that exactly one **ExecutionContext** exists per **StepExecution** at any given time. Clients of the **ExecutionContext** should be careful, because this creates a shared key space. As a result, care should be taken when putting values in to ensure no data is overwritten. However, the **Step** stores absolutely no data in the context, so there is no way to adversely affect the framework.

It is also important to note that there is at least one **ExecutionContext** per **JobExecution** and one for every **StepExecution**. For example, consider the following code snippet:

```
ExecutionContext ecStep = stepExecution.getExecutionContext();
ExecutionContext ecJob = jobExecution.getExecutionContext();
//ecStep does not equal ecJob
```

As noted in the comment, `ecStep` does not equal `ecJob`. They are two different `ExecutionContexts`. The one scoped to the `Step` is saved at every commit point in the `Step`, whereas the one scoped to the `Job` is saved in between every `Step` execution.

3.4. JobRepository

`JobRepository` is the persistence mechanism for all of the Stereotypes mentioned above. It provides CRUD operations for `JobLauncher`, `Job`, and `Step` implementations. When a `Job` is first launched, a `JobExecution` is obtained from the repository, and, during the course of execution, `StepExecution` and `JobExecution` implementations are persisted by passing them to the repository.

The batch namespace provides support for configuring a `JobRepository` instance with the `<job-repository>` tag, as shown in the following example:

```
<job-repository id="jobRepository"/>
```

When using java configuration, `@EnableBatchProcessing` annotation provides a `JobRepository` as one of the components automatically configured out of the box.

3.5. JobLauncher

`JobLauncher` represents a simple interface for launching a `Job` with a given set of `JobParameters`, as shown in the following example:

```
public interface JobLauncher {

    public JobExecution run(Job job, JobParameters jobParameters)
        throws JobExecutionAlreadyRunningException, JobRestartException,
            JobInstanceAlreadyCompleteException, JobParametersInvalidException;

}
```

It is expected that implementations obtain a valid `JobExecution` from the `JobRepository` and execute the `Job`.

3.6. Item Reader

`ItemReader` is an abstraction that represents the retrieval of input for a `Step`, one item at a time. When the `ItemReader` has exhausted the items it can provide, it indicates this by returning `null`. More details about the `ItemReader` interface and its various implementations can be found in [Readers And Writers](#).

3.7. Item Writer

`ItemWriter` is an abstraction that represents the output of a `Step`, one batch or chunk of items at a time. Generally, an `ItemWriter` has no knowledge of the input it should receive next and knows only the item that was passed in its current invocation. More details about the `ItemWriter` interface and its various implementations can be found in [Readers And Writers](#).

3.8. Item Processor

`ItemProcessor` is an abstraction that represents the business processing of an item. While the `ItemReader` reads one item, and the `ItemWriter` writes them, the `ItemProcessor` provides an access point to transform or apply other business processing. If, while processing the item, it is determined that the item is not valid, returning `null` indicates that the item should not be written out. More details about the `ItemProcessor` interface can be found in [Readers And Writers](#).

3.9. Batch Namespace

Many of the domain concepts listed previously need to be configured in a Spring `ApplicationContext`. While there are implementations of the interfaces above that can be used in a standard bean definition, a namespace has been provided for ease of configuration, as shown in the following example:

```
<beans:beans xmlns="http://www.springframework.org/schema/batch"
xmlns:beans="http://www.springframework.org/schema/beans"
xmlns:xsi="http://www.w3.org/2001/XMLSchema-instance"
xsi:schemaLocation="
    http://www.springframework.org/schema/beans
    https://www.springframework.org/schema/beans/spring-beans.xsd
    http://www.springframework.org/schema/batch
    https://www.springframework.org/schema/batch/spring-batch.xsd">

<job id="ioSampleJob">
  <step id="step1">
    <tasklet>
      <chunk reader="itemReader" writer="itemWriter" commit-interval="2"/>
    </tasklet>
  </step>
</job>

</beans:beans>
```

As long as the batch namespace has been declared, any of its elements can be used. More information on configuring a Job can be found in [Configuring and Running a Job](#). More information on configuring a `Step` can be found in [Configuring a Step](#).

Chapter 4. Configuring and Running a Job

In the [domain section](#), the overall architecture design was discussed, using the following diagram as a guide:

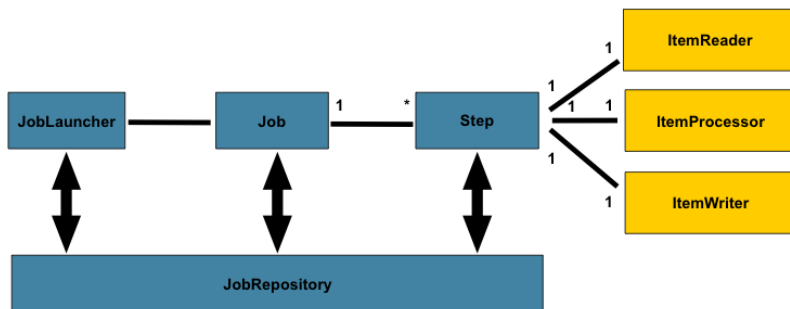

Figure 7. Batch Stereotypes

While the **Job** object may seem like a simple container for steps, there are many configuration options of which a developer must be aware. Furthermore, there are many considerations for how a **Job** will be run and how its meta-data will be stored during that run. This chapter will explain the various configuration options and runtime concerns of a **Job**.

4.1. Configuring a Job

There are multiple implementations of the **Job** interface, however this is abstracted behind either the builders provided for java configuration or the XML namespace when using XML based configuration.

Java Configuration

```
@Bean
public Job footballJob() {
    return this.jobBuilderFactory.get("footballJob")
        .start(playerLoad())
        .next(gameLoad())
        .next(playerSummarization())
        .end()
        .build();
}
```

XML Configuration

```
<job id="footballJob">
  <step id="playerload" parent="s1" next="gameLoad"/>
  <step id="gameLoad" parent="s2" next="playerSummarization"/>
  <step id="playerSummarization" parent="s3"/>
</job>
```

The examples here use a parent bean definition to create the steps; see the section on [step configuration](#) for more options declaring specific step details inline. The XML namespace defaults

to referencing a repository with an id of 'jobRepository', which is a sensible default. However, this can be overridden explicitly:

```
<job id="footballJob" job-repository="specialRepository">
  <step id="playerload"      parent="s1" next="gameLoad"/>
  <step id="gameLoad"       parent="s3" next="playerSummarization"/>
  <step id="playerSummarization" parent="s3"/>
</job>
```

In addition to steps a job configuration can contain other elements that help with parallelisation (<split>), declarative flow control (<decision>) and externalization of flow definitions (<flow/>).

4.1.1. Restartability

One key issue when executing a batch job concerns the behavior of a `Job` when it is restarted. The launching of a `Job` is considered to be a 'restart' if a `JobExecution` already exists for the particular `JobInstance`. Ideally, all jobs should be able to start up where they left off, but there are scenarios where this is not possible. *It is entirely up to the developer to ensure that a new `JobInstance` is created in this scenario.* However, Spring Batch does provide some help. If a `Job` should never be restarted, but should always be run as part of a new `JobInstance`, then the `restartable` property may be set to 'false':

XML Configuration

```
<job id="footballJob" restartable="false">
  ...
</job>
```

Java Configuration

```
@Bean
public Job footballJob() {
    return this.jobBuilderFactory.get("footballJob")
        .preventRestart()
        ...
        .build();
}
```

To phrase it another way, setting `restartable` to false means "this `Job` does not support being started again". Restarting a `Job` that is not restartable will cause a `JobRestartException` to be thrown:

```

Job job = new SimpleJob();
job.setRestartable(false);

JobParameters jobParameters = new JobParameters();

JobExecution firstExecution = jobRepository.createJobExecution(job, jobParameters);
jobRepository.saveOrUpdate(firstExecution);

try {
    jobRepository.createJobExecution(job, jobParameters);
    fail();
}
catch (JobRestartException e) {
    // expected
}

```

This snippet of JUnit code shows how attempting to create a `JobExecution` the first time for a non-restartable job will cause no issues. However, the second attempt will throw a `JobRestartException`.

4.1.2. Intercepting Job Execution

During the course of the execution of a Job, it may be useful to be notified of various events in its lifecycle so that custom code may be executed. The `SimpleJob` allows for this by calling a `JobListener` at the appropriate time:

```

public interface JobExecutionListener {

    void beforeJob(JobExecution jobExecution);

    void afterJob(JobExecution jobExecution);

}

```

`JobListeners` can be added to a `SimpleJob` via the `listeners` element on the job:

XML Configuration

```

<job id="footballJob">
  <step id="playerload"          parent="s1" next="gameLoad"/>
  <step id="gameLoad"           parent="s2" next="playerSummarization"/>
  <step id="playerSummarization" parent="s3"/>
  <listeners>
    <listener ref="sampleListener"/>
  </listeners>
</job>

```

```
@Bean
public Job footballJob() {
    return this.jobBuilderFactory.get("footballJob")
        .listener(sampleListener())
        ...
        .build();
}
```

It should be noted that `afterJob` will be called regardless of the success or failure of the Job. If success or failure needs to be determined it can be obtained from the `JobExecution`:

```
public void afterJob(JobExecution jobExecution){
    if( jobExecution.getStatus() == BatchStatus.COMPLETED ){
        //job success
    }
    else if(jobExecution.getStatus() == BatchStatus.FAILED){
        //job failure
    }
}
```

The annotations corresponding to this interface are:

- `@BeforeJob`
- `@AfterJob`

4.1.3. Inheriting from a Parent Job

If a group of Jobs share similar, but not identical, configurations, then it may be helpful to define a "parent" Job from which the concrete Jobs may inherit properties. Similar to class inheritance in Java, the "child" Job will combine its elements and attributes with the parent's.

In the following example, "baseJob" is an abstract Job definition that defines only a list of listeners. The Job "job1" is a concrete definition that inherits the list of listeners from "baseJob" and merges it with its own list of listeners to produce a Job with two listeners and one Step, "step1".

```

<job id="baseJob" abstract="true">
  <listeners>
    <listener ref="listenerOne"/>
  </listeners>
</job>

<job id="job1" parent="baseJob">
  <step id="step1" parent="standaloneStep"/>

  <listeners merge="true">
    <listener ref="listenerTwo"/>
  </listeners>
</job>

```

Please see the section on [Inheriting from a Parent Step](#) for more detailed information.

This section only applies to XML based configuration as java configuration provides better reuse capabilities.

4.1.4. JobParametersValidator

A job declared in the XML namespace or using any subclass of `AbstractJob` can optionally declare a validator for the job parameters at runtime. This is useful when for instance you need to assert that a job is started with all its mandatory parameters. There is a `DefaultJobParametersValidator` that can be used to constrain combinations of simple mandatory and optional parameters, and for more complex constraints you can implement the interface yourself.

The configuration of a validator is supported through the java builders, e.g:

```

@Bean
public Job job1() {
    return this.jobBuilderFactory.get("job1")
        .validator(parametersValidator())
        ...
        .build();
}

```

XML namespace support is also available for configuration of a `JobParametersValidator`:

```

<job id="job1" parent="baseJob3">
  <step id="step1" parent="standaloneStep"/>
  <validator ref="parametersValidator"/>
</job>

```

The validator can be specified as a reference (as above) or as a nested bean definition in the beans namespace.

4.2. Java Config

Spring 3 brought the ability to configure applications via java in addition to XML. As of Spring Batch 2.2.0, batch jobs can be configured using the same java config. There are two components for the java based configuration: the `@EnableBatchProcessing` annotation and two builders.

The `@EnableBatchProcessing` works similarly to the other `@Enable*` annotations in the Spring family. In this case, `@EnableBatchProcessing` provides a base configuration for building batch jobs. Within this base configuration, an instance of `StepScope` is created in addition to a number of beans made available to be autowired:

- `JobRepository` - bean name "jobRepository"
- `JobLauncher` - bean name "jobLauncher"
- `JobRegistry` - bean name "jobRegistry"
- `PlatformTransactionManager` - bean name "transactionManager"
- `JobBuilderFactory` - bean name "jobBuilders"
- `StepBuilderFactory` - bean name "stepBuilders"

The core interface for this configuration is the `BatchConfigurer`. The default implementation provides the beans mentioned above and requires a `DataSource` as a bean within the context to be provided. This data source will be used by the `JobRepository`. You can customize any of these beans by creating a custom implementation of the `BatchConfigurer` interface. Typically, extending the `DefaultBatchConfigurer` (which is provided if a `BatchConfigurer` is not found) and overriding the required getter is sufficient. However, implementing your own from scratch may be required. The following example shows how to provide a custom transaction manager:

```
@Bean
public BatchConfigurer batchConfigurer() {
    return new DefaultBatchConfigurer() {
        @Override
        public PlatformTransactionManager getTransactionManager() {
            return new MyTransactionManager();
        }
    };
}
```



Only one configuration class needs to have the `@EnableBatchProcessing` annotation. Once you have a class annotated with it, you will have all of the above available.

With the base configuration in place, a user can use the provided builder factories to configure a job. Below is an example of a two step job configured via the `JobBuilderFactory` and the `StepBuilderFactory`.

```

@Configuration
@EnableBatchProcessing
@Import({DataSourceConfiguration.class})
public class AppConfig {

    @Autowired
    private JobBuilderFactory jobs;

    @Autowired
    private StepBuilderFactory steps;

    @Bean
    public Job job(@Qualifier("step1") Step step1, @Qualifier("step2") Step step2) {
        return jobs.get("myJob").start(step1).next(step2).build();
    }

    @Bean
    protected Step step1(ItemReader<Person> reader,
                        ItemProcessor<Person, Person> processor,
                        ItemWriter<Person> writer) {
        return steps.get("step1")
            .<Person, Person> chunk(10)
            .reader(reader)
            .processor(processor)
            .writer(writer)
            .build();
    }

    @Bean
    protected Step step2(Tasklet tasklet) {
        return steps.get("step2")
            .tasklet(tasklet)
            .build();
    }
}

```

4.3. Configuring a JobRepository

When using `@EnableBatchProcessing`, a `JobRepository` is provided out of the box for you. This section addresses configuring your own.

As described in earlier, the `JobRepository` is used for basic CRUD operations of the various persisted domain objects within Spring Batch, such as `JobExecution` and `StepExecution`. It is required by many of the major framework features, such as the `JobLauncher`, `Job`, and `Step`.

The batch namespace abstracts away many of the implementation details of the `JobRepository` implementations and their collaborators. However, there are still a few configuration options available:

XML Configuration

```
<job-repository id="jobRepository"
  data-source="dataSource"
  transaction-manager="transactionManager"
  isolation-level-for-create="SERIALIZABLE"
  table-prefix="BATCH_"
  max-varchar-length="1000"/>
```

None of the configuration options listed above are required except the id. If they are not set, the defaults shown above will be used. They are shown above for awareness purposes. The `max-varchar-length` defaults to 2500, which is the length of the long `VARCHAR` columns in the [sample schema scripts](#)

When using java configuration, a `JobRepository` is provided for you. A JDBC based one is provided out of the box if a `DataSource` is provided, the `Map` based one if not. However you can customize the configuration of the `JobRepository` via an implementation of the `BatchConfigurer` interface.

Java Configuration

```
...
// This would reside in your BatchConfigurer implementation
@Override
protected JobRepository createJobRepository() throws Exception {
    JobRepositoryFactoryBean factory = new JobRepositoryFactoryBean();
    factory.setDataSource(dataSource);
    factory.setTransactionManager(transactionManager);
    factory.setIsolationLevelForCreate("ISOLATION_SERIALIZABLE");
    factory.setTablePrefix("BATCH_");
    factory.setMaxVarCharLength(1000);
    return factory.getObject();
}
...
```

None of the configuration options listed above are required except the `dataSource` and `transactionManager`. If they are not set, the defaults shown above will be used. They are shown above for awareness purposes. The `max varchar length` defaults to 2500, which is the length of the long `VARCHAR` columns in the [sample schema scripts](#)

4.3.1. Transaction Configuration for the JobRepository

If the namespace or the provided `FactoryBean` is used, transactional advice will be automatically created around the repository. This is to ensure that the batch meta data, including state that is necessary for restarts after a failure, is persisted correctly. The behavior of the framework is not well defined if the repository methods are not transactional. The isolation level in the `create*` method attributes is specified separately to ensure that when jobs are launched, if two processes are trying to launch the same job at the same time, only one will succeed. The default isolation level for that method is `SERIALIZABLE`, which is quite aggressive: `READ_COMMITTED` would work just as well; `READ_UNCOMMITTED` would be fine if two processes are not likely to collide in this way.

However, since a call to the `create*` method is quite short, it is unlikely that the `SERIALIZED` will cause problems, as long as the database platform supports it. However, this can be overridden:

XML Configuration

```
<job-repository id="jobRepository"
    isolation-level-for-create="REPEATABLE_READ" />
```

Java Configuration

```
// This would reside in your BatchConfigurer implementation
@Override
protected JobRepository createJobRepository() throws Exception {
    JobRepositoryFactoryBean factory = new JobRepositoryFactoryBean();
    factory.setDataSource(dataSource);
    factory.setTransactionManager(transactionManager);
    factory.setIsolationLevelForCreate("ISOLATION_REPEATABLE_READ");
    return factory.getObject();
}
```

If the namespace or factory beans aren't used then it is also essential to configure the transactional behavior of the repository using AOP:

XML Configuration

```
<aop:config>
    <aop:advisor
        pointcut="execution(* org.springframework.batch.core.*Repository+.*(..))"
    />
    <advice-ref="txAdvice" />
</aop:config>

<tx:advice id="txAdvice" transaction-manager="transactionManager">
    <tx:attributes>
        <tx:method name="*" />
    </tx:attributes>
</tx:advice>
```

This fragment can be used as is, with almost no changes. Remember also to include the appropriate namespace declarations and to make sure `spring-tx` and `spring-aop` (or the whole of `spring`) are on the classpath.

```
@Bean
public TransactionProxyFactoryBean baseProxy() {
    TransactionProxyFactoryBean transactionProxyFactoryBean = new
TransactionProxyFactoryBean();
    Properties transactionAttributes = new Properties();
    transactionAttributes.setProperty("*", "PROPAGATION_REQUIRED");
    transactionProxyFactoryBean.setTransactionAttributes(transactionAttributes);
    transactionProxyFactoryBean.setTarget(jobRepository());
    transactionProxyFactoryBean.setTransactionManager(transactionManager());
    return transactionProxyFactoryBean;
}
```

4.3.2. Changing the Table Prefix

Another modifiable property of the `JobRepository` is the table prefix of the meta-data tables. By default they are all prefaced with `BATCH_`. `BATCH_JOB_EXECUTION` and `BATCH_STEP_EXECUTION` are two examples. However, there are potential reasons to modify this prefix. If the schema names needs to be prepended to the table names, or if more than one set of meta data tables is needed within the same schema, then the table prefix will need to be changed:

XML Configuration

```
<job-repository id="jobRepository"
    table-prefix="SYSTEM.TEST_" />
```

Java Configuration

```
// This would reside in your BatchConfigurer implementation
@Override
protected JobRepository createJobRepository() throws Exception {
    JobRepositoryFactoryBean factory = new JobRepositoryFactoryBean();
    factory.setDataSource(dataSource);
    factory.setTransactionManager(transactionManager);
    factory.setTablePrefix("SYSTEM.TEST_");
    return factory.getObject();
}
```

Given the above changes, every query to the meta data tables will be prefixed with "SYSTEM.TEST_". `BATCH_JOB_EXECUTION` will be referred to as `SYSTEM.TEST_JOB_EXECUTION`.



Only the table prefix is configurable. The table and column names are not.

4.3.3. In-Memory Repository

There are scenarios in which you may not want to persist your domain objects to the database. One reason may be speed; storing domain objects at each commit point takes extra time. Another reason

may be that you just don't need to persist status for a particular job. For this reason, Spring batch provides an in-memory Map version of the job repository:

XML Configuration

```
<bean id="jobRepository"
      class="
org.springframework.batch.core.repository.support.MapJobRepositoryFactoryBean">
    <property name="transactionManager" ref="transactionManager"/>
</bean>
```

Java Configuration

```
// This would reside in your BatchConfigurer implementation
@Override
protected JobRepository createJobRepository() throws Exception {
    MapJobRepositoryFactoryBean factory = new MapJobRepositoryFactoryBean();
    factory.setTransactionManager(transactionManager);
    return factory.getObject();
}
```

Note that the in-memory repository is volatile and so does not allow restart between JVM instances. It also cannot guarantee that two job instances with the same parameters are launched simultaneously, and is not suitable for use in a multi-threaded Job, or a locally partitioned **Step**. So use the database version of the repository wherever you need those features.

However it does require a transaction manager to be defined because there are rollback semantics within the repository, and because the business logic might still be transactional (e.g. RDBMS access). For testing purposes many people find the **ResourcelessTransactionManager** useful.

4.3.4. Non-standard Database Types in a Repository

If you are using a database platform that is not in the list of supported platforms, you may be able to use one of the supported types, if the SQL variant is close enough. To do this you can use the raw **JobRepositoryFactoryBean** instead of the namespace shortcut and use it to set the database type to the closest match:

XML Configuration

```
<bean id="jobRepository" class="org...JobRepositoryFactoryBean">
    <property name="databaseType" value="db2"/>
    <property name="dataSource" ref="dataSource"/>
</bean>
```

Java Configuration

```
// This would reside in your BatchConfigurer implementation
@Override
protected JobRepository createJobRepository() throws Exception {
    JobRepositoryFactoryBean factory = new JobRepositoryFactoryBean();
    factory.setDataSource(dataSource);
    factory.setDatabaseType("db2");
    factory.setTransactionManager(transactionManager);
    return factory.getObject();
}
```

(The `JobRepositoryFactoryBean` tries to auto-detect the database type from the `DataSource` if it is not specified.) The major differences between platforms are mainly accounted for by the strategy for incrementing primary keys, so often it might be necessary to override the `incrementerFactory` as well (using one of the standard implementations from the Spring Framework).

If even that doesn't work, or you are not using an RDBMS, then the only option may be to implement the various `Dao` interfaces that the `SimpleJobRepository` depends on and wire one up manually in the normal Spring way.

4.4. Configuring a JobLauncher

When using `@EnableBatchProcessing`, a `JobRegistry` is provided out of the box for you. This section addresses configuring your own.

The most basic implementation of the `JobLauncher` interface is the `SimpleJobLauncher`. Its only required dependency is a `JobRepository`, in order to obtain an execution:

XML Configuration

```
<bean id="jobLauncher"
      class="org.springframework.batch.core.launch.support.SimpleJobLauncher">
    <property name="jobRepository" ref="jobRepository" />
</bean>
```

Java Configuration

```
...
// This would reside in your BatchConfigurer implementation
@Override
protected JobLauncher createJobLauncher() throws Exception {
    SimpleJobLauncher jobLauncher = new SimpleJobLauncher();
    jobLauncher.setJobRepository(jobRepository);
    jobLauncher.afterPropertiesSet();
    return jobLauncher;
}
...
```

Once a `JobExecution` is obtained, it is passed to the `execute` method of `Job`, ultimately returning the `JobExecution` to the caller:

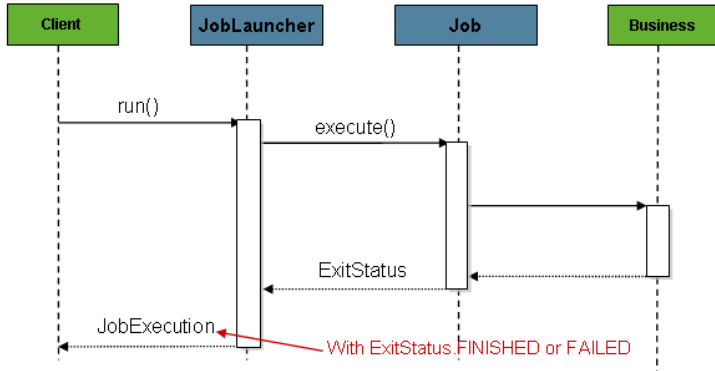

28

Figure 8. Job Launcher Sequence

The sequence is straightforward and works well when launched from a scheduler. However, issues arise when trying to launch from an HTTP request. In this scenario, the launching needs to be done asynchronously so that the `SimpleJobLauncher` returns immediately to its caller. This is because it is not good practice to keep an HTTP request open for the amount of time needed by long running processes such as batch. An example sequence is below:

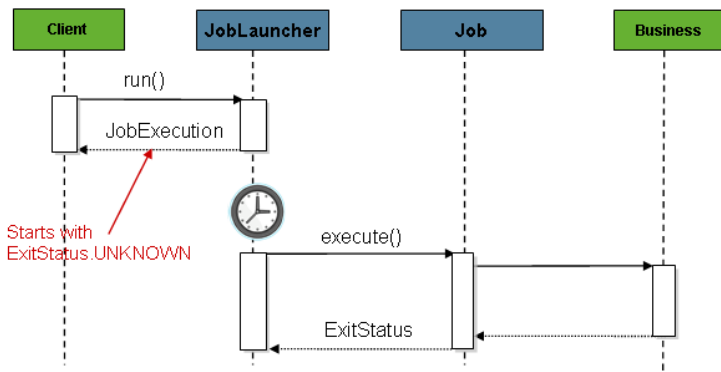

30

Figure 9. Asynchronous Job Launcher Sequence

The `SimpleJobLauncher` can easily be configured to allow for this scenario by configuring a `TaskExecutor`:

XML Configuration

```
<bean id="jobLauncher"
      class="org.springframework.batch.core.launch.support.SimpleJobLauncher">
  <property name="jobRepository" ref="jobRepository" />
  <property name="taskExecutor">
    <bean class="org.springframework.core.task.SimpleAsyncTaskExecutor" />
  </property>
</bean>
```

Java Configuration

```
@Bean
public JobLauncher jobLauncher() {
    SimpleJobLauncher jobLauncher = new SimpleJobLauncher();
    jobLauncher.setJobRepository(jobRepository());
    jobLauncher.setTaskExecutor(new SimpleAsyncTaskExecutor());
    jobLauncher.afterPropertiesSet();
    return jobLauncher;
}
```

Any implementation of the spring `TaskExecutor` interface can be used to control how jobs are asynchronously executed.

4.5. Running a Job

At a minimum, launching a batch job requires two things: the `Job` to be launched and a `JobLauncher`. Both can be contained within the same context or different contexts. For example, if launching a job from the command line, a new JVM will be instantiated for each `Job`, and thus every job will have its own `JobLauncher`. However, if running from within a web container within the scope of an `HttpRequest`, there will usually be one `JobLauncher`, configured for asynchronous job launching, that multiple requests will invoke to launch their jobs.

4.5.1. Running Jobs from the Command Line

For users that want to run their jobs from an enterprise scheduler, the command line is the primary interface. This is because most schedulers (with the exception of Quartz unless using the `NativeJob`) work directly with operating system processes, primarily kicked off with shell scripts. There are many ways to launch a Java process besides a shell script, such as Perl, Ruby, or even 'build tools' such as ant or maven. However, because most people are familiar with shell scripts, this example will focus on them.

The `CommandLineJobRunner`

Because the script launching the job must kick off a Java Virtual Machine, there needs to be a class with a main method to act as the primary entry point. Spring Batch provides an implementation that serves just this purpose: `CommandLineJobRunner`. It's important to note that this is just one way to bootstrap your application, but there are many ways to launch a Java process, and this class should

in no way be viewed as definitive. The `CommandLineJobRunner` performs four tasks:

- Load the appropriate `ApplicationContext`
- Parse command line arguments into `JobParameters`
- Locate the appropriate job based on arguments
- Use the `JobLauncher` provided in the application context to launch the job.

All of these tasks are accomplished using only the arguments passed in. The following are required arguments:

Table 14. `CommandLineJobRunner` arguments

<code>jobPath</code>	The location of the XML file that will be used to create an <code>ApplicationContext</code> . This file should contain everything needed to run the complete Job
<code>jobName</code>	The name of the job to be run.

These arguments must be passed in with the path first and the name second. All arguments after these are considered to be `JobParameters` and must be in the format of 'name=value':

```
<bash$ java CommandLineJobRunner endOfDayJob.xml endOfDay
schedule.date(date)=2007/05/05
```

```
<bash$ java CommandLineJobRunner io.spring.EndOfDayJobConfiguration endOfDay
schedule.date(date)=2007/05/05
```

In most cases you would want to use a manifest to declare your main class in a jar, but for simplicity, the class was used directly. This example is using the same 'EndOfDay' example from the [domainLanguageOfBatch](#). The first argument is where your job is configured (either an XML file or a fully qualified class name). The second argument, 'endOfDay' represents the job name. The final argument, 'schedule.date(date)=2007/05/05' will be converted into `JobParameters`. An example of the configuration is below:

XML Configuration

```
<job id="endOfDay">
  <step id="step1" parent="simpleStep" />
</job>

<!-- Launcher details removed for clarity -->
<beans:bean id="jobLauncher"
  class="org.springframework.batch.core.launch.support.SimpleJobLauncher" />
```

```
@Configuration
@EnableBatchProcessing
public class EndOfDayJobConfiguration {

    @Autowired
    private JobBuilderFactory jobBuilderFactory;

    @Autowired
    private StepBuilderFactory stepBuilderFactory;

    @Bean
    public Job endOfDay() {
        return this.jobBuilderFactory.get("endOfDay")
            .start(step1())
            .build();
    }

    @Bean
    public Step step1() {
        return this.stepBuilderFactory.get("step1")
            .tasklet((contribution, chunkContext) -> null)
            .build();
    }
}
```

This example is overly simplistic, since there are many more requirements to run a batch job in Spring Batch in general, but it serves to show the two main requirements of the `CommandLineJobRunner`: `Job` and `JobLauncher`

ExitCodes

When launching a batch job from the command-line, an enterprise scheduler is often used. Most schedulers are fairly dumb and work only at the process level. This means that they only know about some operating system process such as a shell script that they're invoking. In this scenario, the only way to communicate back to the scheduler about the success or failure of a job is through return codes. A return code is a number that is returned to a scheduler by the process that indicates the result of the run. In the simplest case: 0 is success and 1 is failure. However, there may be more complex scenarios: If job A returns 4 kick off job B, and if it returns 5 kick off job C. This type of behavior is configured at the scheduler level, but it is important that a processing framework such as Spring Batch provide a way to return a numeric representation of the 'Exit Code' for a particular batch job. In Spring Batch this is encapsulated within an `ExitStatus`, which is covered in more detail in Chapter 5. For the purposes of discussing exit codes, the only important thing to know is that an `ExitStatus` has an exit code property that is set by the framework (or the developer) and is returned as part of the `JobExecution` returned from the `JobLauncher`. The `CommandLineJobRunner` converts this string value to a number using the `ExitCodeMapper` interface:

```
public interface ExitCodeMapper {

    public int intValue(String exitCode);

}
```

The essential contract of an `ExitCodeMapper` is that, given a string exit code, a number representation will be returned. The default implementation used by the job runner is the `SimpleJvmExitCodeMapper` that returns 0 for completion, 1 for generic errors, and 2 for any job runner errors such as not being able to find a `Job` in the provided context. If anything more complex than the 3 values above is needed, then a custom implementation of the `ExitCodeMapper` interface must be supplied. Because the `CommandLineJobRunner` is the class that creates an `ApplicationContext`, and thus cannot be 'wired together', any values that need to be overwritten must be autowired. This means that if an implementation of `ExitCodeMapper` is found within the `BeanFactory`, it will be injected into the runner after the context is created. All that needs to be done to provide your own `ExitCodeMapper` is to declare the implementation as a root level bean and ensure that it is part of the `ApplicationContext` that is loaded by the runner.

4.5.2. Running Jobs from within a Web Container

Historically, offline processing such as batch jobs have been launched from the command-line, as described above. However, there are many cases where launching from an `HttpRequest` is a better option. Many such use cases include reporting, ad-hoc job running, and web application support. Because a batch job by definition is long running, the most important concern is ensuring to launch the job asynchronously:

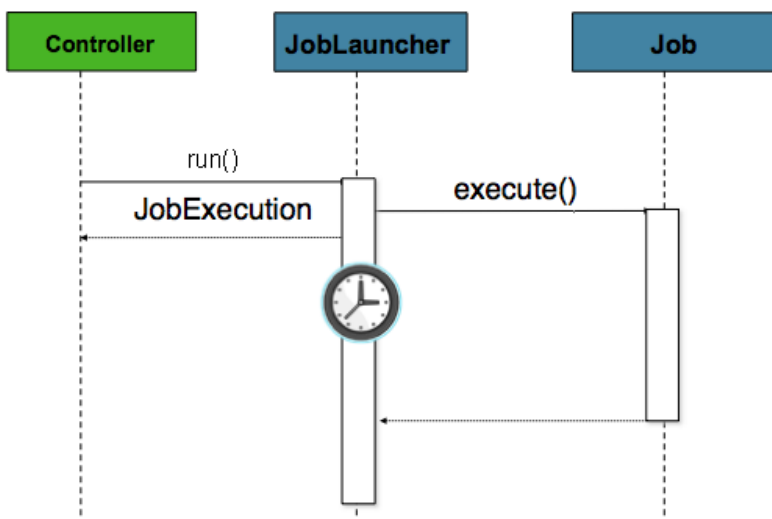

Figure 10. Asynchronous Job Launcher Sequence From Web Container

The controller in this case is a Spring MVC controller. More information on Spring MVC can be found here: <https://docs.spring.io/spring/docs/current/spring-framework-reference/web.html#mvc>. The controller launches a `Job` using a `JobLauncher` that has been configured to launch `asynchronously`, which immediately returns a `JobExecution`. The `Job` will likely still be running, however, this nonblocking behaviour allows the controller to return immediately, which is required when handling an `HttpRequest`. An example is below:

```

@Controller
public class JobLauncherController {

    @Autowired
    JobLauncher jobLauncher;

    @Autowired
    Job job;

    @RequestMapping("/jobLauncher.html")
    public void handle() throws Exception{
        jobLauncher.run(job, new JobParameters());
    }
}

```

4.6. Advanced Meta-Data Usage

So far, both the `JobLauncher` and `JobRepository` interfaces have been discussed. Together, they represent simple launching of a job, and basic CRUD operations of batch domain objects:

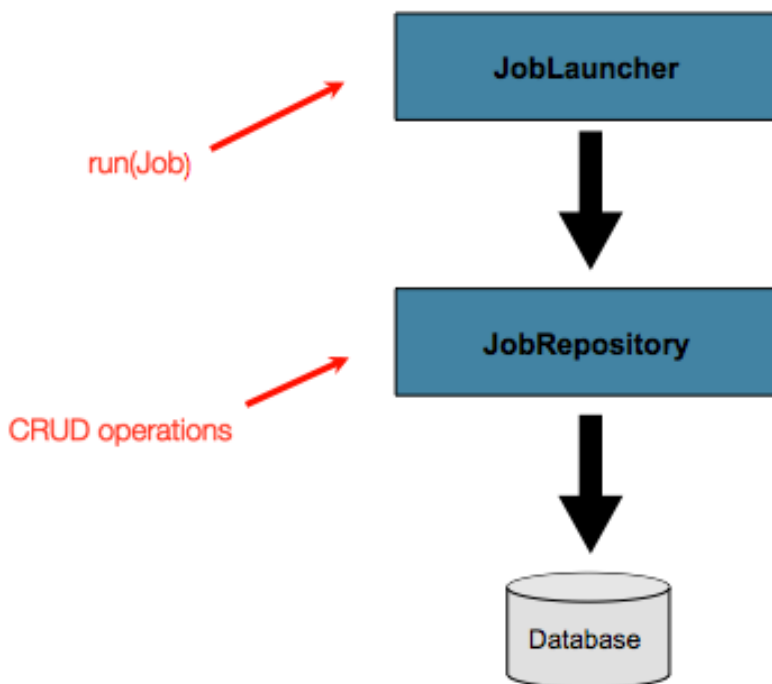

Figure 11. Job Repository

A `JobLauncher` uses the `JobRepository` to create new `JobExecution` objects and run them. `Job` and `Step` implementations later use the same `JobRepository` for basic updates of the same executions during the running of a `Job`. The basic operations suffice for simple scenarios, but in a large batch environment with hundreds of batch jobs and complex scheduling requirements, more advanced access of the meta data is required:

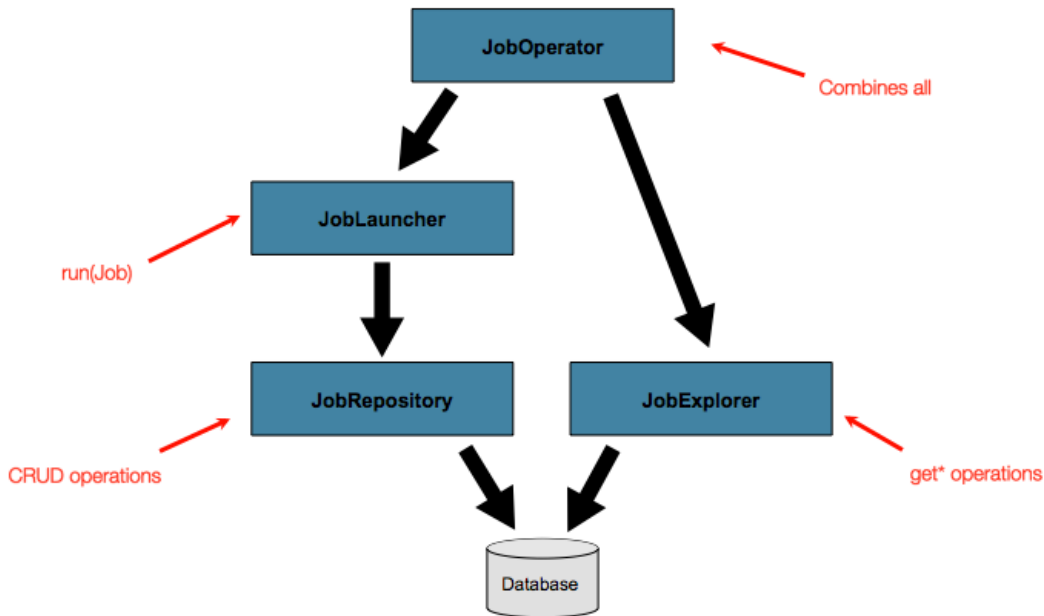

Figure 12. Advanced Job Repository Access

The `JobExplorer` and `JobOperator` interfaces, which will be discussed below, add additional functionality for querying and controlling the meta data.

4.6.1. Querying the Repository

The most basic need before any advanced features is the ability to query the repository for existing executions. This functionality is provided by the `JobExplorer` interface:

```

public interface JobExplorer {

    List<JobInstance> getJobInstances(String jobName, int start, int count);

    JobExecution getJobExecution(Long executionId);

    StepExecution getStepExecution(Long jobExecutionId, Long stepExecutionId);

    JobInstance getJobInstance(Long instanceId);

    List<JobExecution> getJobExecutions(JobInstance jobInstance);

    Set<JobExecution> findRunningJobExecutions(String jobName);
}
  
```

As is evident from the method signatures above, `JobExplorer` is a read-only version of the `JobRepository`, and like the `JobRepository`, it can be easily configured via a factory bean:

XML Configuration

```
<bean id="jobExplorer" class="org.spr...JobExplorerFactoryBean"
      p:dataSource-ref="dataSource" />
```

Java Configuration

```
...
// This would reside in your BatchConfigurer implementation
@Override
public JobExplorer getJobExplorer() throws Exception {
    JobExplorerFactoryBean factoryBean = new JobExplorerFactoryBean();
    factoryBean.setDataSource(this.dataSource);
    return factoryBean.getObject();
}
...
```

Earlier in this chapter, it was mentioned that the table prefix of the `JobRepository` can be modified to allow for different versions or schemas. Because the `JobExplorer` is working with the same tables, it too needs the ability to set a prefix:

XML Configuration

```
<bean id="jobExplorer" class="org.spr...JobExplorerFactoryBean"
      p:tablePrefix="SYSTEM." />
```

Java Configuration

```
...
// This would reside in your BatchConfigurer implementation
@Override
public JobExplorer getJobExplorer() throws Exception {
    JobExplorerFactoryBean factoryBean = new JobExplorerFactoryBean();
    factoryBean.setDataSource(this.dataSource);
    factoryBean.setTablePrefix("SYSTEM.");
    return factoryBean.getObject();
}
...
```

4.6.2. JobRegistry

A `JobRegistry` (and its parent interface `JobLocator`) is not mandatory, but it can be useful if you want to keep track of which jobs are available in the context. It is also useful for collecting jobs centrally in an application context when they have been created elsewhere (e.g. in child contexts). Custom `JobRegistry` implementations can also be used to manipulate the names and other properties of the jobs that are registered. There is only one implementation provided by the framework and this is based on a simple map from job name to job instance.

```
<bean id="jobRegistry" class=
"org.springframework.batch.core.configuration.support.MapJobRegistry" />
```

When using `@EnableBatchProcessing`, a `JobRegistry` is provided out of the box for you. If you want to configure your own:

```
...
// This is already provided via the @EnableBatchProcessing but can be customized via
// overriding the getter in the SimpleBatchConfiguration
@Override
@Bean
public JobRegistry jobRegistry() throws Exception {
    return new MapJobRegistry();
}
...
```

There are two ways to populate a `JobRegistry` automatically: using a bean post processor and using a registrar lifecycle component. These two mechanisms are described in the following sections.

JobRegistryBeanPostProcessor

This is a bean post-processor that can register all jobs as they are created:

XML Configuration

```
<bean id="jobRegistryBeanPostProcessor" class="org.spr...JobRegistryBeanPostProcessor
">
    <property name="jobRegistry" ref="jobRegistry"/>
</bean>
```

Java Configuration

```
@Bean
public JobRegistryBeanPostProcessor jobRegistryBeanPostProcessor() {
    JobRegistryBeanPostProcessor postProcessor = new JobRegistryBeanPostProcessor();
    postProcessor.setJobRegistry(jobRegistry());
    return postProcessor;
}
```

Although it is not strictly necessary, the post-processor in the example has been given an id so that it can be included in child contexts (e.g. as a parent bean definition) and cause all jobs created there to also be registered automatically.

AutomaticJobRegistrar

This is a lifecycle component that creates child contexts and registers jobs from those contexts as they are created. One advantage of doing this is that, while the job names in the child contexts still

have to be globally unique in the registry, their dependencies can have "natural" names. So for example, you can create a set of XML configuration files each having only one Job, but all having different definitions of an `ItemReader` with the same bean name, e.g. "reader". If all those files were imported into the same context, the reader definitions would clash and override one another, but with the automatic registrar this is avoided. This makes it easier to integrate jobs contributed from separate modules of an application.

XML Configuration

```
<bean class="org.spr...AutomaticJobRegistrar">
  <property name="applicationContextFactories">
    <bean class="org.spr...ClasspathXmlApplicationContextsFactoryBean">
      <property name="resources" value="classpath*/config/job*.xml" />
    </bean>
  </property>
  <property name="jobLoader">
    <bean class="org.spr...DefaultJobLoader">
      <property name="jobRegistry" ref="jobRegistry" />
    </bean>
  </property>
</bean>
```

Java Configuration

```
@Bean
public AutomaticJobRegistrar registrar() {

    AutomaticJobRegistrar registrar = new AutomaticJobRegistrar();
    registrar.setJobLoader(jobLoader());
    registrar.setApplicationContextFactories(applicationContextFactories());
    registrar.afterPropertiesSet();
    return registrar;
}
```

The registrar has two mandatory properties, one is an array of `ApplicationContextFactory` (here created from a convenient factory bean), and the other is a `JobLoader`. The `JobLoader` is responsible for managing the lifecycle of the child contexts and registering jobs in the `JobRegistry`.

The `ApplicationContextFactory` is responsible for creating the child context and the most common usage would be as above using a `ClassPathXmlApplicationContextFactory`. One of the features of this factory is that by default it copies some of the configuration down from the parent context to the child. So for instance you don't have to re-define the `PropertyPlaceholderConfigurer` or AOP configuration in the child, if it should be the same as the parent.

The `AutomaticJobRegistrar` can be used in conjunction with a `JobRegistryBeanPostProcessor` if desired (as long as the `DefaultJobLoader` is used as well). For instance this might be desirable if there are jobs defined in the main parent context as well as in the child locations.

4.6.3. JobOperator

As previously discussed, the `JobRepository` provides CRUD operations on the meta-data, and the `JobExplorer` provides read-only operations on the meta-data. However, those operations are most useful when used together to perform common monitoring tasks such as stopping, restarting, or summarizing a Job, as is commonly done by batch operators. Spring Batch provides these types of operations via the `JobOperator` interface:

```
public interface JobOperator {

    List<Long> getExecutions(long instanceId) throws NoSuchJobInstanceException;

    List<Long> getJobInstances(String jobName, int start, int count)
        throws NoSuchJobException;

    Set<Long> getRunningExecutions(String jobName) throws NoSuchJobException;

    String getParameters(long executionId) throws NoSuchJobExecutionException;

    Long start(String jobName, String parameters)
        throws NoSuchJobException, JobInstanceAlreadyExistsException;

    Long restart(long executionId)
        throws JobInstanceAlreadyCompleteException, NoSuchJobExecutionException,
            NoSuchJobException, JobRestartException;

    Long startNextInstance(String jobName)
        throws NoSuchJobException, JobParametersNotFoundExcepion,
            JobRestartException,
            JobExecutionAlreadyRunningException,
            JobInstanceAlreadyCompleteException;

    boolean stop(long executionId)
        throws NoSuchJobExecutionException, JobExecutionNotRunningException;

    String getSummary(long executionId) throws NoSuchJobExecutionException;

    Map<Long, String> getStepExecutionSummaries(long executionId)
        throws NoSuchJobExecutionException;

    Set<String> getJobNames();

}
```

The above operations represent methods from many different interfaces, such as `JobLauncher`, `JobRepository`, `JobExplorer`, and `JobRegistry`. For this reason, the provided implementation of `JobOperator`, `SimpleJobOperator`, has many dependencies:

```

<bean id="jobOperator" class="org.spr...SimpleJobOperator">
  <property name="jobExplorer">
    <bean class="org.spr...JobExplorerFactoryBean">
      <property name="dataSource" ref="dataSource" />
    </bean>
  </property>
  <property name="jobRepository" ref="jobRepository" />
  <property name="jobRegistry" ref="jobRegistry" />
  <property name="jobLauncher" ref="jobLauncher" />
</bean>

```

```

/**
 * All injected dependencies for this bean are provided by the @EnableBatchProcessing
 * infrastructure out of the box.
 */
@Bean
public SimpleJobOperator jobOperator(JobExplorer jobExplorer,
                                     JobRepository jobRepository,
                                     JobRegistry jobRegistry) {

    SimpleJobOperator jobOperator = new SimpleJobOperator();

    jobOperator.setJobExplorer(jobExplorer);
    jobOperator.setJobRepository(jobRepository);
    jobOperator.setJobRegistry(jobRegistry);
    jobOperator.setJobLauncher(jobLauncher);

    return jobOperator;
}

```



If you set the table prefix on the job repository, don't forget to set it on the job explorer as well.

4.6.4. JobParametersIncrementer

Most of the methods on `JobOperator` are self-explanatory, and more detailed explanations can be found on the [javadoc of the interface](#). However, the `startNextInstance` method is worth noting. This method will always start a new instance of a Job. This can be extremely useful if there are serious issues in a `JobExecution` and the Job needs to be started over again from the beginning. Unlike `JobLauncher` though, which requires a new `JobParameters` object that will trigger a new `JobInstance` if the parameters are different from any previous set of parameters, the `startNextInstance` method will use the `JobParametersIncrementer` tied to the `Job` to force the `Job` to a new instance:

```
public interface JobParametersIncrementer {

    JobParameters getNext(JobParameters parameters);

}
```

The contract of `JobParametersIncrementer` is that, given a `JobParameters` object, it will return the 'next' `JobParameters` object by incrementing any necessary values it may contain. This strategy is useful because the framework has no way of knowing what changes to the `JobParameters` make it the 'next' instance. For example, if the only value in `JobParameters` is a date, and the next instance should be created, should that value be incremented by one day? Or one week (if the job is weekly for instance)? The same can be said for any numerical values that help to identify the Job, as shown below:

```
public class SampleIncrementer implements JobParametersIncrementer {

    public JobParameters getNext(JobParameters parameters) {
        if (parameters==null || parameters.isEmpty()) {
            return new JobParametersBuilder().addLong("run.id", 1L).toJobParameters();
        }
        long id = parameters.getLong("run.id", 1L) + 1;
        return new JobParametersBuilder().addLong("run.id", id).toJobParameters();
    }

}
```

In this example, the value with a key of 'run.id' is used to discriminate between `JobInstances`. If the `JobParameters` passed in is null, it can be assumed that the `Job` has never been run before and thus its initial state can be returned. However, if not, the old value is obtained, incremented by one, and returned.

An incrementer can be associated with `Job` via the 'incrementer' attribute in the namespace:

```
<job id="footballJob" incrementer="sampleIncrementer">
    ...
</job>
```

The java config builders also provide facilities for the configuration of an incrementer:

```
@Bean
public Job footballJob() {
    return this.jobBuilderFactory.get("footballJob")
        .incrementer(sampleIncrementer())
        ...
        .build();
}
```

4.6.5. Stopping a Job

One of the most common use cases of `JobOperator` is gracefully stopping a Job:

```
Set<Long> executions = jobOperator.getRunningExecutions("sampleJob");
jobOperator.stop(executions.iterator().next());
```

The shutdown is not immediate, since there is no way to force immediate shutdown, especially if the execution is currently in developer code that the framework has no control over, such as a business service. However, as soon as control is returned back to the framework, it will set the status of the current `StepExecution` to `BatchStatus.STOPPED`, save it, then do the same for the `JobExecution` before finishing.

4.6.6. Aborting a Job

A job execution which is `FAILED` can be restarted (if the `Job` is restartable). A job execution whose status is `ABANDONED` will not be restarted by the framework. The `ABANDONED` status is also used in step executions to mark them as skippable in a restarted job execution: if a job is executing and encounters a step that has been marked `ABANDONED` in the previous failed job execution, it will move on to the next step (as determined by the job flow definition and the step execution exit status).

If the process died ("`kill -9`" or server failure) the job is, of course, not running, but the `JobRepository` has no way of knowing because no-one told it before the process died. You have to tell it manually that you know that the execution either failed or should be considered aborted (change its status to `FAILED` or `ABANDONED`) - it's a business decision and there is no way to automate it. Only change the status to `FAILED` if it is not restartable, or if you know the restart data is valid. There is a utility in Spring Batch Admin `JobService` to abort a job execution.

Chapter 5. Configuring a Step

As discussed in the [domain chapter](#), a **Step** is a domain object that encapsulates an independent, sequential phase of a batch job and contains all of the information necessary to define and control the actual batch processing. This is a necessarily vague description because the contents of any given **Step** are at the discretion of the developer writing a **Job**. A **Step** can be as simple or complex as the developer desires. A simple **Step** might load data from a file into the database, requiring little or no code (depending upon the implementations used). A more complex **Step** might have complicated business rules that are applied as part of the processing, as shown in the following image:

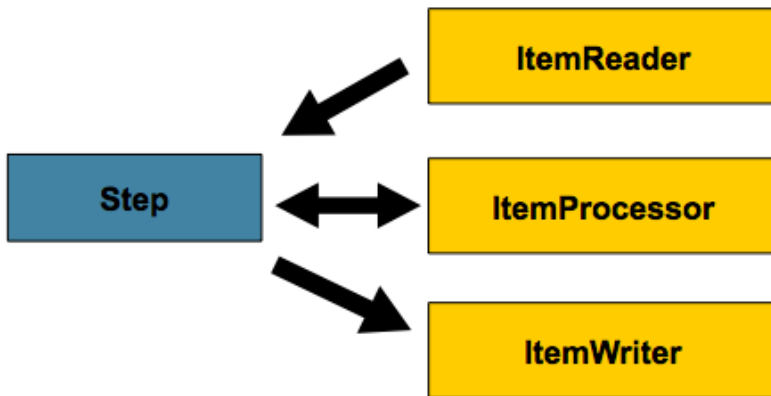

Figure 13. Step

5.1. Chunk-oriented Processing

Spring Batch uses a 'Chunk-oriented' processing style within its most common implementation. Chunk oriented processing refers to reading the data one at a time and creating 'chunks' that are written out within a transaction boundary. One item is read in from an **ItemReader**, handed to an **ItemProcessor**, and aggregated. Once the number of items read equals the commit interval, the entire chunk is written out by the **ItemWriter**, and then the transaction is committed. The following image shows the process:

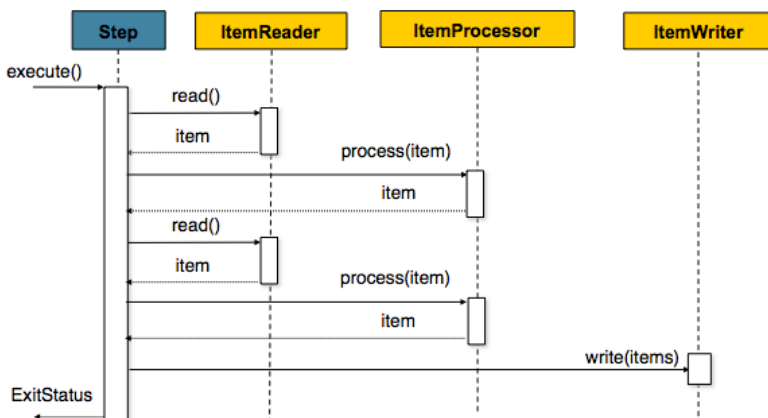

Figure 14. Chunk-oriented Processing

The following code shows the same concepts shown:

```

List items = new ArrayList();
for(int i = 0; i < commitInterval; i++){
    Object item = itemReader.read()
    Object processedItem = itemProcessor.process(item);
    items.add(processedItem);
}
itemWriter.write(items);

```

5.1.1. Configuring a Step

Despite the relatively short list of required dependencies for a **Step**, it is an extremely complex class that can potentially contain many collaborators.

In order to ease configuration, the Spring Batch namespace can be used, as shown in the following example:

XML Configuration

```

<job id="sampleJob" job-repository="jobRepository">
  <step id="step1">
    <tasklet transaction-manager="transactionManager">
      <chunk reader="itemReader" writer="itemWriter" commit-interval="10"/>
    </tasklet>
  </step>
</job>

```

When using java configuration, the Spring Batch builders can be used, as shown in the following example:

```
/**
 * Note the JobRepository is typically autowired in and not needed to be explicitly
 * configured
 */
@Bean
public Job sampleJob(JobRepository jobRepository, Step sampleStep) {
    return this.jobBuilderFactory.get("sampleJob")
        .repository(jobRepository)
        .start(sampleStep)
        .build();
}

/**
 * Note the TransactionManager is typically autowired in and not needed to be
 explicitly
 * configured
 */
@Bean
public Step sampleStep(PlatformTransactionManager transactionManager) {
    return this.stepBuilderFactory.get("sampleStep")
        .transactionManager(transactionManager)
        .<String, String>chunk(10)
        .reader(itemReader())
        .writer(itemWriter())
        .build();
}
```

The configuration above includes the only required dependencies to create a item-oriented step:

- **reader**: The `ItemReader` that provides items for processing.
- **writer**: The `ItemWriter` that processes the items provided by the `ItemReader`.
- **transaction-manager/transactionManager**: Spring's `PlatformTransactionManager` that begins and commits transactions during processing.
- **job-repository/repository**: The `JobRepository` that periodically stores the `StepExecution` and `ExecutionContext` during processing (just before committing). In XML, for an in-line `<step/>` (one defined within a `<job/>`), it is an attribute on the `<job/>` element. For a standalone step, it is defined as an attribute of the `<tasklet/>`.
- **commit-interval/chunk**: The number of items to be processed before the transaction is committed.

It should be noted that `job-repository/repository` defaults to `jobRepository` and `transaction-manager/transactionManager` defaults to `transactionManager`. Also, the `ItemProcessor` is optional, since the item could be directly passed from the reader to the writer.

5.1.2. Inheriting from a Parent Step

If a group of **Steps** share similar configurations, then it may be helpful to define a "parent" **Step** from which the concrete **Steps** may inherit properties. Similar to class inheritance in Java, the "child" **Step** combines its elements and attributes with the parent's. The child also overrides any of the parent's **Steps**.

In the following example, the **Step**, "concreteStep1", inherits from "parentStep". It is instantiated with 'itemReader', 'itemProcessor', 'itemWriter', `startLimit=5`, and `allowStartIfComplete=true`. Additionally, the `commitInterval` is '5', since it is overridden by the "concreteStep1" **Step**, as shown in the following example:

```
<step id="parentStep">
  <tasklet allow-start-if-complete="true">
    <chunk reader="itemReader" writer="itemWriter" commit-interval="10"/>
  </tasklet>
</step>

<step id="concreteStep1" parent="parentStep">
  <tasklet start-limit="5">
    <chunk processor="itemProcessor" commit-interval="5"/>
  </tasklet>
</step>
```

The `id` attribute is still required on the step within the job element. This is for two reasons:

- The `id` is used as the step name when persisting the **StepExecution**. If the same standalone step is referenced in more than one step in the job, an error occurs.
- When creating job flows, as described later in this chapter, the `next` attribute should be referring to the step in the flow, not the standalone step.

Abstract Step

Sometimes, it may be necessary to define a parent **Step** that is not a complete **Step** configuration. If, for instance, the `reader`, `writer`, and `tasklet` attributes are left off of a **Step** configuration, then initialization fails. If a parent must be defined without these properties, then the `abstract` attribute should be used. An **abstract Step** is only extended, never instantiated.

In the following example, the **Step** `abstractParentStep` would not be instantiated if it were not declared to be abstract. The **Step**, "concreteStep2", has 'itemReader', 'itemWriter', and `commitInterval=10`.

```

<step id="abstractParentStep" abstract="true">
  <tasklet>
    <chunk commit-interval="10"/>
  </tasklet>
</step>

<step id="concreteStep2" parent="abstractParentStep">
  <tasklet>
    <chunk reader="itemReader" writer="itemWriter"/>
  </tasklet>
</step>

```

Merging Lists

Some of the configurable elements on *Steps* are lists, such as the `<listeners/>` element. If both the parent and child *Steps* declare a `<listeners/>` element, then the child's list overrides the parent's. In order to allow a child to add additional listeners to the list defined by the parent, every list element has a `merge` attribute. If the element specifies that `merge="true"`, then the child's list is combined with the parent's instead of overriding it.

In the following example, the *Step* "concreteStep3", is created with two listeners: `listenerOne` and `listenerTwo`:

```

<step id="listenersParentStep" abstract="true">
  <listeners>
    <listener ref="listenerOne"/>
  </listeners>
</step>

<step id="concreteStep3" parent="listenersParentStep">
  <tasklet>
    <chunk reader="itemReader" writer="itemWriter" commit-interval="5"/>
  </tasklet>
  <listeners merge="true">
    <listener ref="listenerTwo"/>
  </listeners>
</step>

```

5.1.3. The Commit Interval

As mentioned previously, a step reads in and writes out items, periodically committing using the supplied `PlatformTransactionManager`. With a `commit-interval` of 1, it commits after writing each individual item. This is less than ideal in many situations, since beginning and committing a transaction is expensive. Ideally, it is preferable to process as many items as possible in each transaction, which is completely dependent upon the type of data being processed and the resources with which the step is interacting. For this reason, the number of items that are processed within a commit can be configured. The following example shows a *step* whose *tasklet*

has a `commit-interval` value of 10.

XML Configuration

```
<job id="sampleJob">
  <step id="step1">
    <tasklet>
      <chunk reader="itemReader" writer="itemWriter" commit-interval="10"/>
    </tasklet>
  </step>
</job>
```

Java Configuration

```
@Bean
public Job sampleJob() {
    return this.jobBuilderFactory.get("sampleJob")
        .start(step1())
        .end()
        .build();
}

@Bean
public Step step1() {
    return this.stepBuilderFactory.get("step1")
        .<String, String>chunk(10)
        .reader(itemReader())
        .writer(itemWriter())
        .build();
}
```

In the preceding example, 10 items are processed within each transaction. At the beginning of processing, a transaction is begun. Also, each time `read` is called on the `ItemReader`, a counter is incremented. When it reaches 10, the list of aggregated items is passed to the `ItemWriter`, and the transaction is committed.

5.1.4. Configuring a Step for Restart

In the "[Configuring and Running a Job](#)" section, restarting a `Job` was discussed. Restart has numerous impacts on steps, and, consequently, may require some specific configuration.

Setting a Start Limit

There are many scenarios where you may want to control the number of times a `Step` may be started. For example, a particular `Step` might need to be configured so that it only runs once because it invalidates some resource that must be fixed manually before it can be run again. This is configurable on the step level, since different steps may have different requirements. A `Step` that may only be executed once can exist as part of the same `Job` as a `Step` that can be run infinitely. The following code fragment shows an example of a start limit configuration:

XML Configuration

```
<step id="step1">
  <tasklet start-limit="1">
    <chunk reader="itemReader" writer="itemWriter" commit-interval="10"/>
  </tasklet>
</step>
```

Java Configuration

```
@Bean
public Step step1() {
    return this.stepBuilderFactory.get("step1")
        .<String, String>chunk(10)
        .reader(itemReader())
        .writer(itemWriter())
        .startLimit(1)
        .build();
}
```

The step above can be run only once. Attempting to run it again causes a `StartLimitExceededException` to be thrown. Note that the default value for the `start-limit` is `Integer.MAX_VALUE`.

Restarting a Completed Step

In the case of a restartable job, there may be one or more steps that should always be run, regardless of whether or not they were successful the first time. An example might be a validation step or a `Step` that cleans up resources before processing. During normal processing of a restarted job, any step with a status of 'COMPLETED', meaning it has already been completed successfully, is skipped. Setting `allow-start-if-complete` to "true" overrides this so that the step always runs, as shown in the following example:

XML Configuration

```
<step id="step1">
  <tasklet allow-start-if-complete="true">
    <chunk reader="itemReader" writer="itemWriter" commit-interval="10"/>
  </tasklet>
</step>
```

```
@Bean
public Step step1() {
    return this.stepBuilderFactory.get("step1")
        .<String, String>chunk(10)
        .reader(itemReader())
        .writer(itemWriter())
        .allowStartIfComplete(true)
        .build();
}
```

Step Restart Configuration Example

The following example shows how to configure a job to have steps that can be restarted:

XML Configuration

```
<job id="footballJob" restartable="true">
  <step id="playerload" next="gameLoad">
    <tasklet>
      <chunk reader="playerFileItemReader" writer="playerWriter"
        commit-interval="10" />
    </tasklet>
  </step>
  <step id="gameLoad" next="playerSummarization">
    <tasklet allow-start-if-complete="true">
      <chunk reader="gameFileItemReader" writer="gameWriter"
        commit-interval="10"/>
    </tasklet>
  </step>
  <step id="playerSummarization">
    <tasklet start-limit="2">
      <chunk reader="playerSummarizationSource" writer="summaryWriter"
        commit-interval="10"/>
    </tasklet>
  </step>
</job>
```

```

@Bean
public Job footballJob() {
    return this.jobBuilderFactory.get("footballJob")
        .start(playerLoad())
        .next(gameLoad())
        .next(playerSummarization())
        .end()
        .build();
}

@Bean
public Step playerLoad() {
    return this.stepBuilderFactory.get("playerLoad")
        .<String, String>chunk(10)
        .reader(playerFileItemReader())
        .writer(playerWriter())
        .build();
}

@Bean
public Step gameLoad() {
    return this.stepBuilderFactory.get("gameLoad")
        .allowStartIfComplete(true)
        .<String, String>chunk(10)
        .reader(gameFileItemReader())
        .writer(gameWriter())
        .build();
}

@Bean
public Step playerSummarization() {
    return this.stepBuilderFactory.get("playerSummarization")
        .startLimit(2)
        .<String, String>chunk(10)
        .reader(playerSummarizationSource())
        .writer(summaryWriter())
        .build();
}

```

The preceding example configuration is for a job that loads in information about football games and summarizes them. It contains three steps: `playerLoad`, `gameLoad`, and `playerSummarization`. The `playerLoad` step loads player information from a flat file, while the `gameLoad` step does the same for games. The final step, `playerSummarization`, then summarizes the statistics for each player, based upon the provided games. It is assumed that the file loaded by `playerLoad` must be loaded only once, but that `gameLoad` can load any games found within a particular directory, deleting them after they have been successfully loaded into the database. As a result, the `playerLoad` step contains no additional configuration. It can be started any number of times, and, if complete, is skipped. The `gameLoad` step, however, needs to be run every time in case extra files have been added since it last

ran. It has 'allow-start-if-complete' set to 'true' in order to always be started. (It is assumed that the database tables games are loaded into has a process indicator on it, to ensure new games can be properly found by the summarization step). The summarization step, which is the most important in the job, is configured to have a start limit of 2. This is useful because if the step continually fails, a new exit code is returned to the operators that control job execution, and it can not start again until manual intervention has taken place.



This job provides an example for this document and is not the same as the `footballJob` found in the samples project.

The remainder of this section describes what happens for each of the three runs of the `footballJob` example.

Run 1:

1. `playerLoad` runs and completes successfully, adding 400 players to the 'PLAYERS' table.
2. `gameLoad` runs and processes 11 files worth of game data, loading their contents into the 'GAMES' table.
3. `playerSummarization` begins processing and fails after 5 minutes.

Run 2:

1. `playerLoad` does not run, since it has already completed successfully, and `allow-start-if-complete` is 'false' (the default).
2. `gameLoad` runs again and processes another 2 files, loading their contents into the 'GAMES' table as well (with a process indicator indicating they have yet to be processed).
3. `playerSummarization` begins processing of all remaining game data (filtering using the process indicator) and fails again after 30 minutes.

Run 3:

1. `playerLoad` does not run, since it has already completed successfully, and `allow-start-if-complete` is 'false' (the default).
2. `gameLoad` runs again and processes another 2 files, loading their contents into the 'GAMES' table as well (with a process indicator indicating they have yet to be processed).
3. `playerSummarization` is not started and the job is immediately killed, since this is the third execution of `playerSummarization`, and its limit is only 2. Either the limit must be raised or the `Job` must be executed as a new `JobInstance`.

5.1.5. Configuring Skip Logic

There are many scenarios where errors encountered while processing should not result in `Step` failure, but should be skipped instead. This is usually a decision that must be made by someone who understands the data itself and what meaning it has. Financial data, for example, may not be skippable because it results in money being transferred, which needs to be completely accurate. Loading a list of vendors, on the other hand, might allow for skips. If a vendor is not loaded because it was formatted incorrectly or was missing necessary information, then there probably are not

issues. Usually, these bad records are logged as well, which is covered later when discussing listeners.

The following example shows an example of using a skip limit:

XML Configuration

```
<step id="step1">
  <tasklet>
    <chunk reader="flatFileItemReader" writer="itemWriter"
      commit-interval="10" skip-limit="10">
      <skippable-exception-classes>
        <include class="
org.springframework.batch.item.file.FlatFileParseException"/>
      </skippable-exception-classes>
    </chunk>
  </tasklet>
</step>
```

Java Configuration

```
@Bean
public Step step1() {
    return this.stepBuilderFactory.get("step1")
        .<String, String>chunk(10)
        .reader(flatFileItemReader())
        .writer(itemWriter())
        .faultTolerant()
        .skipLimit(10)
        .skip(FlatFileParseException.class)
        .build();
}
```

In the preceding example, a `FlatFileItemReader` is used. If, at any point, a `FlatFileParseException` is thrown, the item is skipped and counted against the total skip limit of 10. Exceptions (and their subclasses) that are declared might be thrown during any phase of the chunk processing (read, process, write) but separate counts are made of skips on read, process, and write inside the step execution, but the limit applies across all skips. Once the skip limit is reached, the next exception found causes the step to fail. In other words, the eleventh skip triggers the exception, not the tenth.

One problem with the preceding example is that any other exception besides a `FlatFileParseException` causes the `Job` to fail. In certain scenarios, this may be the correct behavior. However, in other scenarios, it may be easier to identify which exceptions should cause failure and skip everything else, as shown in the following example:

XML Configuration

```
<step id="step1">
  <tasklet>
    <chunk reader="flatFileItemReader" writer="itemWriter"
      commit-interval="10" skip-limit="10">
      <skippable-exception-classes>
        <include class="java.lang.Exception"/>
        <exclude class="java.io.FileNotFoundException"/>
      </skippable-exception-classes>
    </chunk>
  </tasklet>
</step>
```

Java Configuration

```
@Bean
public Step step1() {
    return this.stepBuilderFactory.get("step1")
        .<String, String>chunk(10)
        .reader(flatFileItemReader())
        .writer(itemWriter())
        .faultTolerant()
        .skipLimit(10)
        .skip(Exception.class)
        .noSkip(FileNotFoundException.class)
        .build();
}
```

By identifying `java.lang.Exception` as a skippable exception class, the configuration indicates that all `Exceptions` are skippable. However, by 'excluding' `java.io.FileNotFoundException`, the configuration refines the list of skippable exception classes to be all `Exceptions` *except* `FileNotFoundException`. Any excluded exception classes is fatal if encountered (that is, they are not skipped).

For any exception encountered, the skippability is determined by the nearest superclass in the class hierarchy. Any unclassified exception is treated as 'fatal'.

The order of specifying include vs exclude (by using either the XML tags or `skip` and `noSkip` method calls) does not matter.

5.1.6. Configuring Retry Logic

In most cases, you want an exception to cause either a skip or a `Step` failure. However, not all exceptions are deterministic. If a `FlatFileParseException` is encountered while reading, it is always thrown for that record. Resetting the `ItemReader` does not help. However, for other exceptions, such as a `DeadlockLoserDataAccessException`, which indicates that the current process has attempted to update a record that another process holds a lock on, waiting and trying again might result in success. In this case, retry should be configured as follows:

```

<step id="step1">
  <tasklet>
    <chunk reader="itemReader" writer="itemWriter"
      commit-interval="2" retry-limit="3">
      <retryable-exception-classes>
        <include class="org.springframework.dao.DeadlockLoserDataAccessException
"/>
      </retryable-exception-classes>
    </chunk>
  </tasklet>
</step>

```

```

@Bean
public Step step1() {
    return this.stepBuilderFactory.get("step1")
        .<String, String>chunk(2)
        .reader(itemReader())
        .writer(itemWriter())
        .faultTolerant()
        .retryLimit(3)
        .retry(DeadlockLoserDataAccessException.class)
        .build();
}

```

The `Step` allows a limit for the number of times an individual item can be retried and a list of exceptions that are 'retryable'. More details on how retry works can be found in [retry](#).

5.1.7. Controlling Rollback

By default, regardless of retry or skip, any exceptions thrown from the `ItemWriter` cause the transaction controlled by the `Step` to rollback. If skip is configured as described earlier, exceptions thrown from the `ItemReader` do not cause a rollback. However, there are many scenarios in which exceptions thrown from the `ItemWriter` should not cause a rollback, because no action has taken place to invalidate the transaction. For this reason, the `Step` can be configured with a list of exceptions that should not cause rollback, as shown in the following example:

XML Configuration

```

<step id="step1">
  <tasklet>
    <chunk reader="itemReader" writer="itemWriter" commit-interval="2"/>
    <no-rollback-exception-classes>
      <include class="org.springframework.batch.item.validator.ValidationException
"/>
    </no-rollback-exception-classes>
  </tasklet>
</step>

```

```
@Bean
public Step step1() {
    return this.stepBuilderFactory.get("step1")
        .<String, String>chunk(2)
        .reader(itemReader())
        .writer(itemWriter())
        .faultTolerant()
        .noRollback(ValidationException.class)
        .build();
}
```

Transactional Readers

The basic contract of the `ItemReader` is that it is forward only. The step buffers reader input, so that in the case of a rollback, the items do not need to be re-read from the reader. However, there are certain scenarios in which the reader is built on top of a transactional resource, such as a JMS queue. In this case, since the queue is tied to the transaction that is rolled back, the messages that have been pulled from the queue are put back on. For this reason, the step can be configured to not buffer the items, as shown in the following example:

XML Configuration

```
<step id="step1">
    <tasklet>
        <chunk reader="itemReader" writer="itemWriter" commit-interval="2"
            is-reader-transactional-queue="true"/>
    </tasklet>
</step>
```

Java Configuration

```
@Bean
public Step step1() {
    return this.stepBuilderFactory.get("step1")
        .<String, String>chunk(2)
        .reader(itemReader())
        .writer(itemWriter())
        .readerIsTransactionalQueue()
        .build();
}
```

5.1.8. Transaction Attributes

Transaction attributes can be used to control the `isolation`, `propagation`, and `timeout` settings. More information on setting transaction attributes can be found in the [Spring core documentation](#). The following example sets the `isolation`, `propagation`, and `timeout` transaction attributes:

XML Configuration

```
<step id="step1">
  <tasklet>
    <chunk reader="itemReader" writer="itemWriter" commit-interval="2"/>
    <transaction-attributes isolation="DEFAULT"
                          propagation="REQUIRED"
                          timeout="30"/>
  </tasklet>
</step>
```

Java Configuration

```
@Bean
public Step step1() {
    DefaultTransactionAttribute attribute = new DefaultTransactionAttribute();
    attribute.setPropagationBehavior(Propagation.REQUIRED.value());
    attribute.setIsolationLevel(Isolation.DEFAULT.value());
    attribute.setTimeout(30);

    return this.stepBuilderFactory.get("step1")
        .<String, String>chunk(2)
        .reader(itemReader())
        .writer(itemWriter())
        .transactionAttribute(attribute)
        .build();
}
```

5.1.9. Registering `ItemStream` with a Step

The step has to take care of `ItemStream` callbacks at the necessary points in its lifecycle (For more information on the `ItemStream` interface, see [ItemStream](#)). This is vital if a step fails and might need to be restarted, because the `ItemStream` interface is where the step gets the information it needs about persistent state between executions.

If the `ItemReader`, `ItemProcessor`, or `ItemWriter` itself implements the `ItemStream` interface, then these are registered automatically. Any other streams need to be registered separately. This is often the case where indirect dependencies, such as delegates, are injected into the reader and writer. A stream can be registered on the `Step` through the 'streams' element, as illustrated in the following example:

XML Configuration

```
<step id="step1">
  <tasklet>
    <chunk reader="itemReader" writer="compositeWriter" commit-interval="2">
      <streams>
        <stream ref="fileItemWriter1"/>
        <stream ref="fileItemWriter2"/>
      </streams>
    </chunk>
  </tasklet>
</step>

<beans:bean id="compositeWriter"
  class="org.springframework.batch.item.support.CompositeItemWriter">
  <beans:property name="delegates">
    <beans:list>
      <beans:ref bean="fileItemWriter1" />
      <beans:ref bean="fileItemWriter2" />
    </beans:list>
  </beans:property>
</beans:bean>
```

```

@Bean
public Step step1() {
    return this.stepBuilderFactory.get("step1")
        .<String, String>chunk(2)
        .reader(itemReader())
        .writer(compositeItemWriter())
        .stream(fileItemWriter1())
        .stream(fileItemWriter2())
        .build();
}

/**
 * In Spring Batch 4, the CompositeItemWriter implements ItemStream so this isn't
 * necessary, but used for an example.
 */
@Bean
public CompositeItemWriter compositeItemWriter() {
    List<ItemWriter> writers = new ArrayList<>(2);
    writers.add(fileItemWriter1());
    writers.add(fileItemWriter2());

    CompositeItemWriter itemWriter = new CompositeItemWriter();

    itemWriter.setDelegates(writers);

    return itemWriter;
}

```

In the example above, the `CompositeItemWriter` is not an `ItemStream`, but both of its delegates are. Therefore, both delegate writers must be explicitly registered as streams in order for the framework to handle them correctly. The `ItemReader` does not need to be explicitly registered as a stream because it is a direct property of the `Step`. The step is now restartable, and the state of the reader and writer is correctly persisted in the event of a failure.

5.1.10. Intercepting Step Execution

Just as with the `Job`, there are many events during the execution of a `Step` where a user may need to perform some functionality. For example, in order to write out to a flat file that requires a footer, the `ItemWriter` needs to be notified when the `Step` has been completed, so that the footer can be written. This can be accomplished with one of many `Step` scoped listeners.

Any class that implements one of the extensions of `StepListener` (but not that interface itself since it is empty) can be applied to a step through the `listeners` element. The `listeners` element is valid inside a step, tasklet, or chunk declaration. It is recommended that you declare the listeners at the level at which its function applies, or, if it is multi-featured (such as `StepExecutionListener` and `ItemReadListener`), then declare it at the most granular level where it applies. The following example shows a listener applied at the chunk level:

XML Configuration

```
<step id="step1">
  <tasklet>
    <chunk reader="reader" writer="writer" commit-interval="10"/>
    <listeners>
      <listener ref="chunkListener"/>
    </listeners>
  </tasklet>
</step>
```

Java Configuration

```
@Bean
public Step step1() {
    return this.stepBuilderFactory.get("step1")
        .<String, String>chunk(10)
        .reader(reader())
        .writer(writer())
        .listener(chunkListener())
        .build();
}
```

An `ItemReader`, `ItemWriter` or `ItemProcessor` that itself implements one of the `StepListener` interfaces is registered automatically with the `Step` if using the namespace `<step>` element or one of the the `*StepFactoryBean` factories. This only applies to components directly injected into the `Step`. If the listener is nested inside another component, it needs to be explicitly registered (as described previously under [Registering ItemStream with a Step](#)).

In addition to the `StepListener` interfaces, annotations are provided to address the same concerns. Plain old Java objects can have methods with these annotations that are then converted into the corresponding `StepListener` type. It is also common to annotate custom implementations of chunk components such as `ItemReader` or `ItemWriter` or `Tasklet`. The annotations are analyzed by the XML parser for the `<listener/>` elements as well as registered with the `listener` methods in the builders, so all you need to do is use the XML namespace or builders to register the listeners with a step.

StepExecutionListener

`StepExecutionListener` represents the most generic listener for `Step` execution. It allows for notification before a `Step` is started and after it ends, whether it ended normally or failed, as shown in the following example:

```
public interface StepExecutionListener extends StepListener {

    void beforeStep(StepExecution stepExecution);

    ExitStatus afterStep(StepExecution stepExecution);

}
```

`ExitStatus` is the return type of `afterStep` in order to allow listeners the chance to modify the exit code that is returned upon completion of a `Step`.

The annotations corresponding to this interface are:

- `@BeforeStep`
- `@AfterStep`

ChunkListener

A chunk is defined as the items processed within the scope of a transaction. Committing a transaction, at each commit interval, commits a 'chunk'. A `ChunkListener` can be used to perform logic before a chunk begins processing or after a chunk has completed successfully, as shown in the following interface definition:

```
public interface ChunkListener extends StepListener {

    void beforeChunk(ChunkContext context);
    void afterChunk(ChunkContext context);
    void afterChunkError(ChunkContext context);

}
```

The `beforeChunk` method is called after the transaction is started but before `read` is called on the `ItemReader`. Conversely, `afterChunk` is called after the chunk has been committed (and not at all if there is a rollback).

The annotations corresponding to this interface are:

- `@BeforeChunk`
- `@AfterChunk`
- `@AfterChunkError`

A `ChunkListener` can be applied when there is no chunk declaration. The `TaskletStep` is responsible for calling the `ChunkListener`, so it applies to a non-item-oriented tasklet as well (it is called before and after the tasklet).

ItemReadListener

When discussing skip logic previously, it was mentioned that it may be beneficial to log the skipped records, so that they can be dealt with later. In the case of read errors, this can be done with an

`ItemReaderListener`, as shown in the following interface definition:

```
public interface ItemReadListener<T> extends StepListener {  
  
    void beforeRead();  
    void afterRead(T item);  
    void onReadError(Exception ex);  
  
}
```

The `beforeRead` method is called before each call to read on the `ItemReader`. The `afterRead` method is called after each successful call to read and is passed the item that was read. If there was an error while reading, the `onReadError` method is called. The exception encountered is provided so that it can be logged.

The annotations corresponding to this interface are:

- `@BeforeRead`
- `@AfterRead`
- `@OnReadError`

`ItemProcessListener`

Just as with the `ItemReadListener`, the processing of an item can be 'listened' to, as shown in the following interface definition:

```
public interface ItemProcessListener<T, S> extends StepListener {  
  
    void beforeProcess(T item);  
    void afterProcess(T item, S result);  
    void onProcessError(T item, Exception e);  
  
}
```

The `beforeProcess` method is called before `process` on the `ItemProcessor` and is handed the item that is to be processed. The `afterProcess` method is called after the item has been successfully processed. If there was an error while processing, the `onProcessError` method is called. The exception encountered and the item that was attempted to be processed are provided, so that they can be logged.

The annotations corresponding to this interface are:

- `@BeforeProcess`
- `@AfterProcess`
- `@OnProcessError`

ItemWriteListener

The writing of an item can be 'listened' to with the `ItemWriteListener`, as shown in the following interface definition:

```
public interface ItemWriteListener<S> extends StepListener {  
  
    void beforeWrite(List<? extends S> items);  
    void afterWrite(List<? extends S> items);  
    void onWriteError(Exception exception, List<? extends S> items);  
  
}
```

The `beforeWrite` method is called before `write` on the `ItemWriter` and is handed the list of items that is written. The `afterWrite` method is called after the item has been successfully written. If there was an error while writing, the `onWriteError` method is called. The exception encountered and the item that was attempted to be written are provided, so that they can be logged.

The annotations corresponding to this interface are:

- `@BeforeWrite`
- `@AfterWrite`
- `@OnWriteError`

SkipListener

`ItemReadListener`, `ItemProcessListener`, and `ItemWriteListener` all provide mechanisms for being notified of errors, but none informs you that a record has actually been skipped. `onWriteError`, for example, is called even if an item is retried and successful. For this reason, there is a separate interface for tracking skipped items, as shown in the following interface definition:

```
public interface SkipListener<T,S> extends StepListener {  
  
    void onSkipInRead(Throwable t);  
    void onSkipInProcess(T item, Throwable t);  
    void onSkipInWrite(S item, Throwable t);  
  
}
```

`onSkipInRead` is called whenever an item is skipped while reading. It should be noted that rollbacks may cause the same item to be registered as skipped more than once. `onSkipInWrite` is called when an item is skipped while writing. Because the item has been read successfully (and not skipped), it is also provided the item itself as an argument.

The annotations corresponding to this interface are:

- `@OnSkipInRead`
- `@OnSkipInWrite`
- `@OnSkipInProcess`

SkipListeners and Transactions

One of the most common use cases for a `SkipListener` is to log out a skipped item, so that another batch process or even human process can be used to evaluate and fix the issue leading to the skip. Because there are many cases in which the original transaction may be rolled back, Spring Batch makes two guarantees:

1. The appropriate skip method (depending on when the error happened) is called only once per item.
2. The `SkipListener` is always called just before the transaction is committed. This is to ensure that any transactional resources call by the listener are not rolled back by a failure within the `ItemWriter`.

5.2. TaskletStep

[Chunk-oriented processing](#) is not the only way to process in a `Step`. What if a `Step` must consist of a simple stored procedure call? You could implement the call as an `ItemReader` and return null after the procedure finishes. However, doing so is a bit unnatural, since there would need to be a no-op `ItemWriter`. Spring Batch provides the `TaskletStep` for this scenario.

`Tasklet` is a simple interface that has one method, `execute`, which is called repeatedly by the `TaskletStep` until it either returns `RepeatStatus.FINISHED` or throws an exception to signal a failure. Each call to a `Tasklet` is wrapped in a transaction. `Tasklet` implementors might call a stored procedure, a script, or a simple SQL update statement.

To create a `TaskletStep` the bean associated with the step (through the `ref` attribute when using the namespace or passed to the `tasklet` method when using java config), should be a bean that implements the interface `Tasklet`. The following example shows a simple `tasklet`:

XML Configuration

```
<step id="step1">
  <tasklet ref="myTasklet"/>
</step>
```

Java Configuration

```
@Bean
public Step step1() {
    return this.stepBuilderFactory.get("step1")
        .tasklet(myTasklet())
        .build();
}
```



`TaskletStep` automatically registers the tasklet as a `StepListener` if it implements the `StepListener` interface.

5.2.1. TaskletAdapter

As with other adapters for the `ItemReader` and `ItemWriter` interfaces, the `Tasklet` interface contains an implementation that allows for adapting itself to any pre-existing class: `TaskletAdapter`. An example where this may be useful is an existing DAO that is used to update a flag on a set of records. The `TaskletAdapter` can be used to call this class without having to write an adapter for the `Tasklet` interface, as shown in the following example:

XML Configuration

```
<bean id="myTasklet" class="o.s.b.core.step.tasklet.MethodInvokingTaskletAdapter">
  <property name="targetObject">
    <bean class="org.mycompany.FooDao"/>
  </property>
  <property name="targetMethod" value="updateFoo" />
</bean>
```

Java Configuration

```
@Bean
public MethodInvokingTaskletAdapter myTasklet() {
    MethodInvokingTaskletAdapter adapter = new MethodInvokingTaskletAdapter();

    adapter.setTargetObject(fooDao());
    adapter.setTargetMethod("updateFoo");

    return adapter;
}
```

5.2.2. Example Tasklet Implementation

Many batch jobs contain steps that must be done before the main processing begins in order to set up various resources or after processing has completed to cleanup those resources. In the case of a job that works heavily with files, it is often necessary to delete certain files locally after they have been uploaded successfully to another location. The following example (taken from the [Spring Batch samples project](#)) is a `Tasklet` implementation with just such a responsibility:

```

public class FileDeletingTasklet implements Tasklet, InitializingBean {

    private Resource directory;

    public RepeatStatus execute(StepContribution contribution,
                               ChunkContext chunkContext) throws Exception {
        File dir = directory.getFile();
        Assert.state(dir.isDirectory());

        File[] files = dir.listFiles();
        for (int i = 0; i < files.length; i++) {
            boolean deleted = files[i].delete();
            if (!deleted) {
                throw new UnexpectedJobExecutionException("Could not delete file " +
                                                            files[i].getPath());
            }
        }
        return RepeatStatus.FINISHED;
    }

    public void setDirectoryResource(Resource directory) {
        this.directory = directory;
    }

    public void afterPropertiesSet() throws Exception {
        Assert.notNull(directory, "directory must be set");
    }
}

```

The preceding `Tasklet` implementation deletes all files within a given directory. It should be noted that the `execute` method is called only once. All that is left is to reference the `Tasklet` from the `Step`:

XML Configuration

```

<job id="taskletJob">
    <step id="deleteFilesInDir">
        <tasklet ref="fileDeletingTasklet"/>
    </step>
</job>

<beans:bean id="fileDeletingTasklet"
            class="org.springframework.batch.sample.tasklet.FileDeletingTasklet">
    <beans:property name="directoryResource">
        <beans:bean id="directory"
                    class="org.springframework.core.io.FileSystemResource">
            <beans:constructor-arg value="target/test-outputs/test-dir" />
        </beans:bean>
    </beans:property>
</beans:bean>

```

```
@Bean
public Job taskletJob() {
    return this.jobBuilderFactory.get("taskletJob")
        .start(deleteFilesInDir())
        .build();
}

@Bean
public Step deleteFilesInDir() {
    return this.stepBuilderFactory.get("deleteFilesInDir")
        .tasklet(fileDeletingTasklet())
        .build();
}

@Bean
public FileDeletingTasklet fileDeletingTasklet() {
    FileDeletingTasklet tasklet = new FileDeletingTasklet();

    tasklet.setDirectoryResource(new FileSystemResource("target/test-outputs/test-dir"));

    return tasklet;
}
```

5.3. Controlling Step Flow

With the ability to group steps together within an owning job comes the need to be able to control how the job "flows" from one step to another. The failure of a **Step** does not necessarily mean that the **Job** should fail. Furthermore, there may be more than one type of 'success' that determines which **Step** should be executed next. Depending upon how a group of **Steps** is configured, certain steps may not even be processed at all.

5.3.1. Sequential Flow

The simplest flow scenario is a job where all of the steps execute sequentially, as shown in the following image:

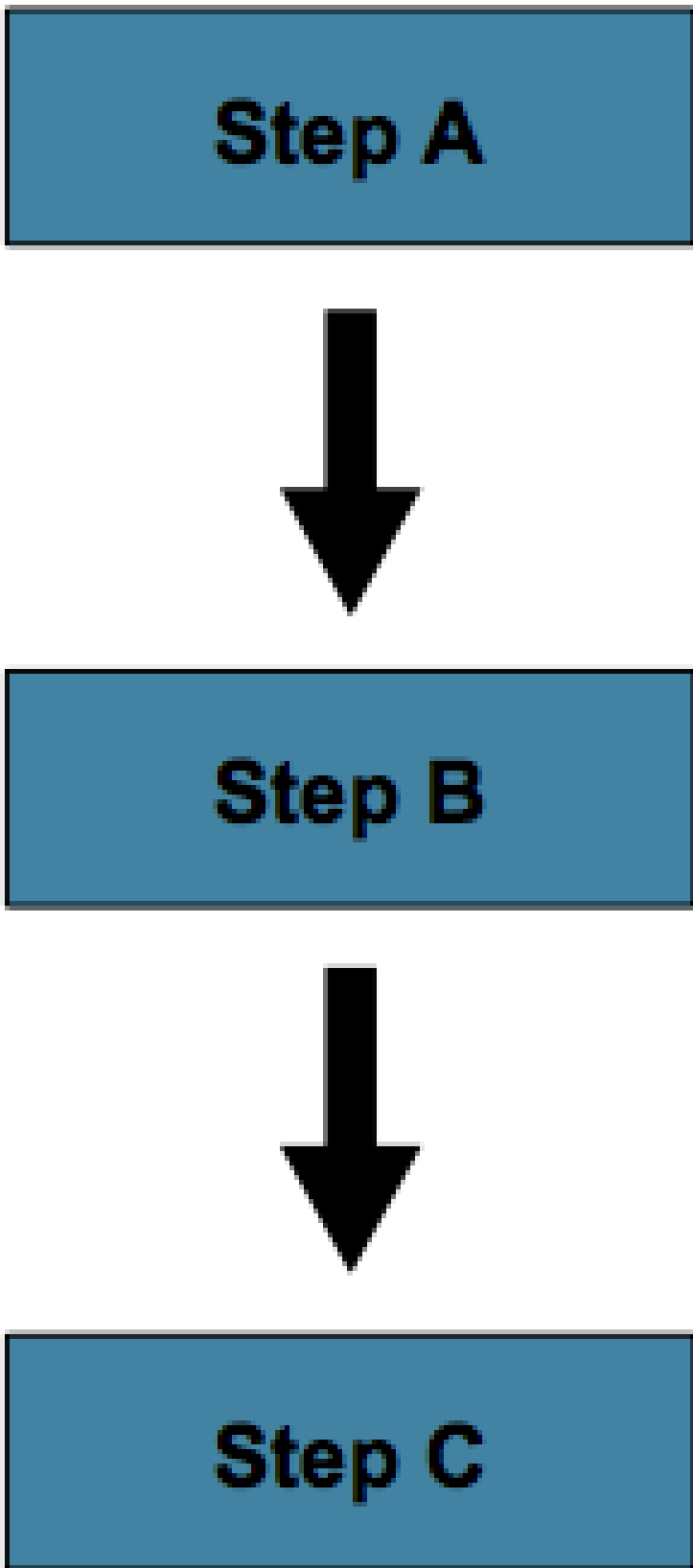

Figure 15. Sequential Flow

This can be achieved by using the 'next' attribute of the step element, as shown in the following example:

XML Configuration

```
<job id="job">
  <step id="stepA" parent="s1" next="stepB" />
  <step id="stepB" parent="s2" next="stepC"/>
  <step id="stepC" parent="s3" />
</job>
```

Java Configuration

```
@Bean
public Job job() {
    return this.jobBuilderFactory.get("job")
        .start(stepA())
        .next(stepB())
        .next(stepC())
        .build();
}
```

In the scenario above, 'step A' runs first because it is the first **Step** listed. If 'step A' completes normally, then 'step B' runs, and so on. However, if 'step A' fails, then the entire **Job** fails and 'step B' does not execute.



With the Spring Batch namespace, the first step listed in the configuration is *always* the first step run by the **Job**. The order of the other step elements does not matter, but the first step must always appear first in the xml.

5.3.2. Conditional Flow

In the example above, there are only two possibilities:

1. The **Step** is successful and the next **Step** should be executed.
2. The **Step** failed and, thus, the **Job** should fail.

In many cases, this may be sufficient. However, what about a scenario in which the failure of a **Step** should trigger a different **Step**, rather than causing failure? The following image shows such a flow:

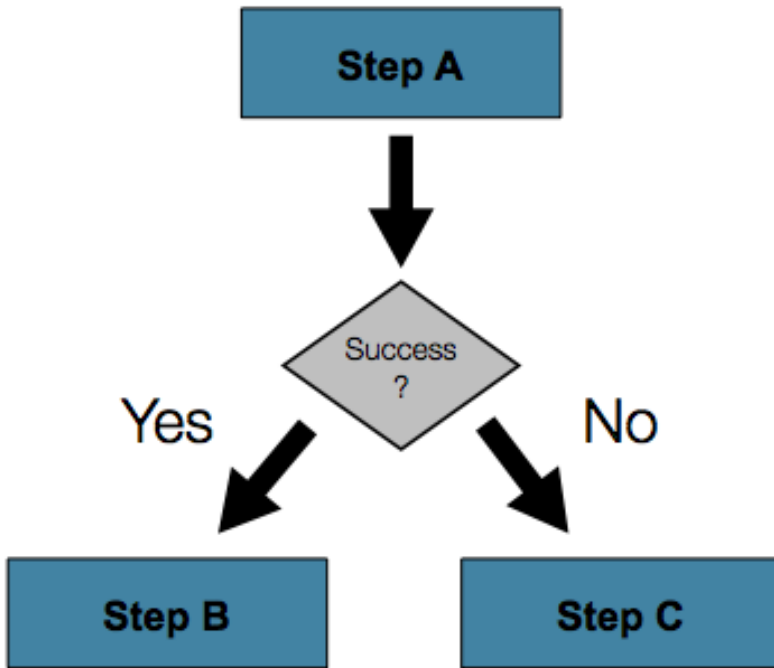

Figure 16. Conditional Flow

In order to handle more complex scenarios, the Spring Batch namespace allows transition elements to be defined within the step element. One such transition is the `next` element. Like the `next` attribute, the `next` element tells the `Job` which `Step` to execute next. However, unlike the attribute, any number of `next` elements are allowed on a given `Step`, and there is no default behavior in the case of failure. This means that, if transition elements are used, then all of the behavior for the `Step` transitions must be defined explicitly. Note also that a single step cannot have both a `next` attribute and a `transition` element.

The `next` element specifies a pattern to match and the step to execute next, as shown in the following example:

XML Configuration

```
<job id="job">
  <step id="stepA" parent="s1">
    <next on="*" to="stepB" />
    <next on="FAILED" to="stepC" />
  </step>
  <step id="stepB" parent="s2" next="stepC" />
  <step id="stepC" parent="s3" />
</job>
```

```
@Bean
public Job job() {
    return this.jobBuilderFactory.get("job")
        .start(stepA())
        .on("*").to(stepB())
        .from(stepA()).on("FAILED").to(stepC())
        .end()
        .build();
}
```

When using XML configuration, the `on` attribute of a transition element uses a simple pattern-matching scheme to match the `ExitStatus` that results from the execution of the `Step`.

When using java configuration the `on` method uses a simple pattern-matching scheme to match the `ExitStatus` that results from the execution of the `Step`.

Only two special characters are allowed in the pattern:

- "*" matches zero or more characters
- "?" matches exactly one character

For example, "c*t" matches "cat" and "count", while "c?t" matches "cat" but not "count".

While there is no limit to the number of transition elements on a `Step`, if the `Step` execution results in an `ExitStatus` that is not covered by an element, then the framework throws an exception and the `Job` fails. The framework automatically orders transitions from most specific to least specific. This means that, even if the ordering were swapped for "stepA" in the example above, an `ExitStatus` of "FAILED" would still go to "stepC".

Batch Status Versus Exit Status

When configuring a `Job` for conditional flow, it is important to understand the difference between `BatchStatus` and `ExitStatus`. `BatchStatus` is an enumeration that is a property of both `JobExecution` and `StepExecution` and is used by the framework to record the status of a `Job` or `Step`. It can be one of the following values: `COMPLETED`, `STARTING`, `STARTED`, `STOPPING`, `STOPPED`, `FAILED`, `ABANDONED`, or `UNKNOWN`. Most of them are self explanatory: `COMPLETED` is the status set when a step or job has completed successfully, `FAILED` is set when it fails, and so on.

The following example contains the 'next' element when using XML configuration:

```
<next on="FAILED" to="stepB" />
```

The following example contains the 'on' element when using Java Configuration:

```
...  
.from(stepA()).on("FAILED").to(stepB())  
...
```

At first glance, it would appear that 'on' references the `BatchStatus` of the `Step` to which it belongs. However, it actually references the `ExitStatus` of the `Step`. As the name implies, `ExitStatus` represents the status of a `Step` after it finishes execution.

More specifically, when using XML configuration, the 'next' element shown in the preceding XML configuration example references the exit code of `ExitStatus`.

When using Java configuration, the 'on' method shown in the preceding Java configuration example references the exit code of `ExitStatus`.

In English, it says: "go to stepB if the exit code is `FAILED`". By default, the exit code is always the same as the `BatchStatus` for the `Step`, which is why the entry above works. However, what if the exit code needs to be different? A good example comes from the skip sample job within the samples project:

XML Configuration

```
<step id="step1" parent="s1">  
  <end on="FAILED" />  
  <next on="COMPLETED WITH SKIPS" to="errorPrint1" />  
  <next on="*" to="step2" />  
</step>
```

Java Configuration

```
@Bean  
public Job job() {  
    return this.jobBuilderFactory.get("job")  
        .start(step1()).on("FAILED").end()  
        .from(step1()).on("COMPLETED WITH SKIPS").to(errorPrint1())  
        .from(step1()).on("*").to(step2())  
        .end()  
        .build();  
}
```

`step1` has three possibilities:

1. The `Step` failed, in which case the job should fail.
2. The `Step` completed successfully.
3. The `Step` completed successfully but with an exit code of 'COMPLETED WITH SKIPS'. In this case, a different step should be run to handle the errors.

The above configuration works. However, something needs to change the exit code based on the

condition of the execution having skipped records, as shown in the following example:

```
public class SkipCheckingListener extends StepExecutionListenerSupport {
    public ExitStatus afterStep(StepExecution stepExecution) {
        String exitCode = stepExecution.getExitStatus().getExitCode();
        if (!exitCode.equals(ExitStatus.FAILED.getExitCode()) &&
            stepExecution.getSkipCount() > 0) {
            return new ExitStatus("COMPLETED WITH SKIPS");
        }
        else {
            return null;
        }
    }
}
```

The above code is a `StepExecutionListener` that first checks to make sure the `Step` was successful and then checks to see if the skip count on the `StepExecution` is higher than 0. If both conditions are met, a new `ExitStatus` with an exit code of `COMPLETED WITH SKIPS` is returned.

5.3.3. Configuring for Stop

After the discussion of `BatchStatus` and `ExitStatus`, one might wonder how the `BatchStatus` and `ExitStatus` are determined for the `Job`. While these statuses are determined for the `Step` by the code that is executed, the statuses for the `Job` are determined based on the configuration.

So far, all of the job configurations discussed have had at least one final `Step` with no transitions. For example, after the following step executes, the `Job` ends, as shown in the following example:

```
<step id="stepC" parent="s3"/>
```

```
@Bean
public Job job() {
    return this.jobBuilderFactory.get("job")
        .start(step1())
        .build();
}
```

If no transitions are defined for a `Step`, then the status of the `Job` is defined as follows:

- If the `Step` ends with `ExitStatus FAILED`, then the `BatchStatus` and `ExitStatus` of the `Job` are both `FAILED`.
- Otherwise, the `BatchStatus` and `ExitStatus` of the `Job` are both `COMPLETED`.

While this method of terminating a batch job is sufficient for some batch jobs, such as a simple sequential step job, custom defined job-stopping scenarios may be required. For this purpose, Spring Batch provides three transition elements to stop a `Job` (in addition to the `next element` that

we discussed previously). Each of these stopping elements stops a **Job** with a particular **BatchStatus**. It is important to note that the stop transition elements have no effect on either the **BatchStatus** or **ExitStatus** of any **Steps** in the **Job**. These elements affect only the final statuses of the **Job**. For example, it is possible for every step in a job to have a status of **FAILED** but for the job to have a status of **COMPLETED**.

Ending at a Step

Configuring a step end instructs a **Job** to stop with a **BatchStatus** of **COMPLETED**. A **Job** that has finished with status **COMPLETED** cannot be restarted (the framework throws a **JobInstanceAlreadyCompleteException**).

When using XML configuration, the 'end' element is used for this task. The **end** element also allows for an optional 'exit-code' attribute that can be used to customize the **ExitStatus** of the **Job**. If no 'exit-code' attribute is given, then the **ExitStatus** is **COMPLETED** by default, to match the **BatchStatus**.

When using Java configuration, the 'end' method is used for this task. The **end** method also allows for an optional 'exitStatus' parameter that can be used to customize the **ExitStatus** of the **Job**. If no 'exitStatus' value is provided, then the **ExitStatus** is **COMPLETED** by default, to match the **BatchStatus**.

In the following scenario, if **step2** fails, then the **Job** stops with a **BatchStatus** of **COMPLETED** and an **ExitStatus** of **COMPLETED** and **step3** does not run. Otherwise, execution moves to **step3**. Note that if **step2** fails, the **Job** is not restartable (because the status is **COMPLETED**).

```
<step id="step1" parent="s1" next="step2">
<step id="step2" parent="s2">
  <end on="FAILED"/>
  <next on="*" to="step3"/>
</step>
<step id="step3" parent="s3">
```

```
@Bean
public Job job() {
    return this.jobBuilderFactory.get("job")
        .start(step1())
        .next(step2())
        .on("FAILED").end()
        .from(step2()).on("*").to(step3())
        .end()
        .build();
}
```

Failing a Step

Configuring a step to fail at a given point instructs a **Job** to stop with a **BatchStatus** of **FAILED**. Unlike **end**, the failure of a **Job** does not prevent the **Job** from being restarted.

When using XML configuration, the 'fail' element also allows for an optional 'exit-code' attribute that can be used to customize the `ExitStatus` of the `Job`. If no 'exit-code' attribute is given, then the `ExitStatus` is `FAILED` by default, to match the `BatchStatus`.

In the following scenario, if `step2` fails, then the `Job` stops with a `BatchStatus` of `FAILED` and an `ExitStatus` of `EARLY TERMINATION` and `step3` does not execute. Otherwise, execution moves to `step3`. Additionally, if `step2` fails and the `Job` is restarted, then execution begins again on `step2`.

XML Configuration

```
<step id="step1" parent="s1" next="step2">

<step id="step2" parent="s2">
    <fail on="FAILED" exit-code="EARLY TERMINATION"/>
    <next on="*" to="step3"/>
</step>

<step id="step3" parent="s3">
```

Java Configuration

```
@Bean
public Job job() {
    return this.jobBuilderFactory.get("job")
        .start(step1())
        .next(step2()).on("FAILED").fail()
        .from(step2()).on("*").to(step3())
        .end()
        .build();
}
```

Stopping a Job at a Given Step

Configuring a job to stop at a particular step instructs a `Job` to stop with a `BatchStatus` of `STOPPED`. Stopping a `Job` can provide a temporary break in processing, so that the operator can take some action before restarting the `Job`.

When using XML configuration 'stop' element requires a 'restart' attribute that specifies the step where execution should pick up when the "Job is restarted".

When using java configuration, the `stopAndRestart` method requires a 'restart' attribute that specifies the step where execution should pick up when the "Job is restarted".

In the following scenario, if `step1` finishes with `COMPLETE`, then the job stops. Once it is restarted, execution begins on `step2`.

```

<step id="step1" parent="s1">
  <stop on="COMPLETED" restart="step2"/>
</step>

<step id="step2" parent="s2"/>

```

```

@Bean
public Job job() {
    return this.jobBuilderFactory.get("job")
        .start(step1()).on("COMPLETED").stopAndRestart(step2())
        .end()
        .build();
}

```

5.3.4. Programmatic Flow Decisions

In some situations, more information than the `ExitStatus` may be required to decide which step to execute next. In this case, a `JobExecutionDecider` can be used to assist in the decision, as shown in the following example:

```

public class MyDecider implements JobExecutionDecider {
    public FlowExecutionStatus decide(JobExecution jobExecution, StepExecution
stepExecution) {
        String status;
        if (someCondition()) {
            status = "FAILED";
        }
        else {
            status = "COMPLETED";
        }
        return new FlowExecutionStatus(status);
    }
}

```

In the following sample job configuration, a `decision` specifies the decider to use as well as all of the transitions:

XML Configuration

```
<job id="job">
  <step id="step1" parent="s1" next="decision" />

  <decision id="decision" decider="decider">
    <next on="FAILED" to="step2" />
    <next on="COMPLETED" to="step3" />
  </decision>

  <step id="step2" parent="s2" next="step3"/>
  <step id="step3" parent="s3" />
</job>

<beans:bean id="decider" class="com.MyDecider"/>
```

In the following example, a bean implementing the `JobExecutionDecider` is passed directly to the `next` call when using Java configuration.

Java Configuration

```
@Bean
public Job job() {
    return this.jobBuilderFactory.get("job")
        .start(step1())
        .next(decider()).on("FAILED").to(step2())
        .from(decider()).on("COMPLETED").to(step3())
        .end()
        .build();
}
```

5.3.5. Split Flows

Every scenario described so far has involved a `Job` that executes its steps one at a time in a linear fashion. In addition to this typical style, Spring Batch also allows for a job to be configured with parallel flows.

The XML namespace allows you to use the 'split' element. As the following example shows, the 'split' element contains one or more 'flow' elements, where entire separate flows can be defined. A 'split' element may also contain any of the previously discussed transition elements, such as the 'next' attribute or the 'next', 'end' or 'fail' elements.

```

<split id="split1" next="step4">
  <flow>
    <step id="step1" parent="s1" next="step2"/>
    <step id="step2" parent="s2"/>
  </flow>
  <flow>
    <step id="step3" parent="s3"/>
  </flow>
</split>
<step id="step4" parent="s4"/>

```

Java based configuration lets you configure splits through the provided builders. As the following example shows, the 'split' element contains one or more 'flow' elements, where entire separate flows can be defined. A 'split' element may also contain any of the previously discussed transition elements, such as the 'next' attribute or the 'next', 'end' or 'fail' elements.

```

@Bean
public Job job() {
    Flow flow1 = new FlowBuilder<SimpleFlow>("flow1")
        .start(step1())
        .next(step2())
        .build();
    Flow flow2 = new FlowBuilder<SimpleFlow>("flow2")
        .start(step3())
        .build();

    return this.jobBuilderFactory.get("job")
        .start(flow1)
        .split(new SimpleAsyncTaskExecutor())
        .add(flow2)
        .next(step4())
        .end()
        .build();
}

```

5.3.6. Externalizing Flow Definitions and Dependencies Between Jobs

Part of the flow in a job can be externalized as a separate bean definition and then re-used. There are two ways to do so. The first is to simply declare the flow as a reference to one defined elsewhere, as shown in the following example:

XML Configuration

```
<job id="job">
  <flow id="job1.flow1" parent="flow1" next="step3"/>
  <step id="step3" parent="s3"/>
</job>

<flow id="flow1">
  <step id="step1" parent="s1" next="step2"/>
  <step id="step2" parent="s2"/>
</flow>
```

Java Configuration

```
@Bean
public Job job() {
    return this.jobBuilderFactory.get("job")
        .start(flow1())
        .next(step3())
        .end()
        .build();
}

@Bean
public Flow flow1() {
    return new FlowBuilder<SimpleFlow>("flow1")
        .start(step1())
        .next(step2())
        .build();
}
```

The effect of defining an external flow as shown in the preceding example is to insert the steps from the external flow into the job as if they had been declared inline. In this way, many jobs can refer to the same template flow and compose such templates into different logical flows. This is also a good way to separate the integration testing of the individual flows.

The other form of an externalized flow is to use a `JobStep`. A `JobStep` is similar to a `FlowStep` but actually creates and launches a separate job execution for the steps in the flow specified.

The following XML snippet shows an example of a `JobStep`:

XML Configuration

```
<job id="jobStepJob" restartable="true">
  <step id="jobStepJob.step1">
    <job ref="job" job-launcher="jobLauncher"
      job-parameters-extractor="jobParametersExtractor"/>
  </step>
</job>

<job id="job" restartable="true">...</job>

<bean id="jobParametersExtractor" class="org.spr...DefaultJobParametersExtractor">
  <property name="keys" value="input.file"/>
</bean>
```

The following Java snippet shows an example of a `JobStep`:

Java Configuration

```
@Bean
public Job jobStepJob() {
    return this.jobBuilderFactory.get("jobStepJob")
        .start(jobStepJobStep1(null))
        .build();
}

@Bean
public Step jobStepJobStep1(JobLauncher jobLauncher) {
    return this.stepBuilderFactory.get("jobStepJobStep1")
        .job(job())
        .launcher(jobLauncher)
        .parametersExtractor(jobParametersExtractor())
        .build();
}

@Bean
public Job job() {
    return this.jobBuilderFactory.get("job")
        .start(step1())
        .build();
}

@Bean
public DefaultJobParametersExtractor jobParametersExtractor() {
    DefaultJobParametersExtractor extractor = new DefaultJobParametersExtractor();

    extractor.setKeys(new String[]{"input.file"});

    return extractor;
}
```

The job parameters extractor is a strategy that determines how the `ExecutionContext` for the `Step` is converted into `JobParameters` for the `Job` that is run. The `JobStep` is useful when you want to have some more granular options for monitoring and reporting on jobs and steps. Using `JobStep` is also often a good answer to the question: "How do I create dependencies between jobs?" It is a good way to break up a large system into smaller modules and control the flow of jobs.

5.4. Late Binding of Job and Step Attributes

Both the XML and flat file examples shown earlier use the Spring `Resource` abstraction to obtain a file. This works because `Resource` has a `getFile` method, which returns a `java.io.File`. Both XML and flat file resources can be configured using standard Spring constructs, as shown in the following example:

XML Configuration

```
<bean id="flatFileItemReader"
      class="org.springframework.batch.item.file.FlatFileItemReader">
  <property name="resource"
            value="file://outputs/file.txt" />
</bean>
```

Java Configuration

```
@Bean
public FlatFileItemReader flatFileItemReader() {
    FlatFileItemReader<Foo> reader = new FlatFileItemReaderBuilder<Foo>()
        .name("flatFileItemReader")
        .resource(new FileSystemResource("file://outputs/file.txt"))
        ...
}
```

The preceding `Resource` loads the file from the specified file system location. Note that absolute locations have to start with a double slash (`file://`). In most Spring applications, this solution is good enough, because the names of these resources are known at compile time. However, in batch scenarios, the file name may need to be determined at runtime as a parameter to the job. This can be solved using `'-D'` parameters to read a system property.

The following XML snippet shows how to read a file name from a property:

XML Configuration

```
<bean id="flatFileItemReader"
      class="org.springframework.batch.item.file.FlatFileItemReader">
  <property name="resource" value="${input.file.name}" />
</bean>
```

The following Java snippet shows how to read a file name from a property:

Java Configuration

```
@Bean
public FlatFileItemReader flatFileItemReader(@Value("${input.file.name}") String name)
{
    return new FlatFileItemReaderBuilder<Foo>()
        .name("flatFileItemReader")
        .resource(new FileSystemResource(name))
        ...
}
```

All that would be required for this solution to work would be a system argument (such as `-Dinput.file.name="file://outputs/file.txt"`).



Although a `PropertyPlaceholderConfigurer` can be used here, it is not necessary if the system property is always set because the `ResourceEditor` in Spring already filters and does placeholder replacement on system properties.

Often, in a batch setting, it is preferable to parametrize the file name in the `JobParameters` of the job, instead of through system properties, and access them that way. To accomplish this, Spring Batch allows for the late binding of various `Job` and `Step` attributes, as shown in the following snippet:

XML Configuration

```
<bean id="flatFileItemReader" scope="step"
      class="org.springframework.batch.item.file.FlatFileItemReader">
    <property name="resource" value="#{jobParameters['input.file.name']}" />
</bean>
```

Java Configuration

```
@StepScope
@Bean
public FlatFileItemReader flatFileItemReader(@Value(
    "#{jobParameters['input.file.name']}") String name) {
    return new FlatFileItemReaderBuilder<Foo>()
        .name("flatFileItemReader")
        .resource(new FileSystemResource(name))
        ...
}
```

Both the `JobExecution` and `StepExecution` level `ExecutionContext` can be accessed in the same way, as shown in the following examples:

XML Configuration

```
<bean id="flatFileItemReader" scope="step"
      class="org.springframework.batch.item.file.FlatFileItemReader">
  <property name="resource" value="#{jobExecutionContext['input.file.name']}" />
</bean>
```

XML Configuration

```
<bean id="flatFileItemReader" scope="step"
      class="org.springframework.batch.item.file.FlatFileItemReader">
  <property name="resource" value="#{stepExecutionContext['input.file.name']}" />
</bean>
```

Java Configuration

```
@StepScope
@Bean
public FlatFileItemReader flatFileItemReader(@Value(
    "#{jobExecutionContext['input.file.name']}") String name) {
    return new FlatFileItemReaderBuilder<Foo>()
        .name("flatFileItemReader")
        .resource(new FileSystemResource(name))
        ...
}
```

Java Configuration

```
@StepScope
@Bean
public FlatFileItemReader flatFileItemReader(@Value(
    "#{stepExecutionContext['input.file.name']}") String name) {
    return new FlatFileItemReaderBuilder<Foo>()
        .name("flatFileItemReader")
        .resource(new FileSystemResource(name))
        ...
}
```



Any bean that uses late-binding must be declared with `scope="step"`. See [Step Scope](#) for more information.

5.4.1. Step Scope

All of the late binding examples from above have a scope of "step" declared on the bean definition, as shown in the following example:

XML Configuration

```
<bean id="flatFileItemReader" scope="step"
      class="org.springframework.batch.item.file.FlatFileItemReader">
  <property name="resource" value="#{jobParameters[input.file.name]}" />
</bean>
```

Java Configuration

```
@StepScope
@Bean
public FlatFileItemReader flatFileItemReader(@Value("
#{jobParameters[input.file.name]}") String name) {
    return new FlatFileItemReaderBuilder<Foo>()
        .name("flatFileItemReader")
        .resource(new FileSystemResource(name))
        ...
}
```

Using a scope of `Step` is required in order to use late binding, because the bean cannot actually be instantiated until the `Step` starts, to allow the attributes to be found. Because it is not part of the Spring container by default, the scope must be added explicitly, by using the `batch` namespace or by including a bean definition explicitly for the `StepScope`, or by using the `@EnableBatchProcessing` annotation. Use only one of those methods. The following example uses the `batch` namespace:

```
<beans xmlns="http://www.springframework.org/schema/beans"
       xmlns:batch="http://www.springframework.org/schema/batch"
       xmlns:xsi="http://www.w3.org/2001/XMLSchema-instance"
       xsi:schemaLocation="...">
  <batch:job .../>
  ...
</beans>
```

The following example includes the bean definition explicitly:

```
<bean class="org.springframework.batch.core.scope.StepScope" />
```

5.4.2. Job Scope

`Job` scope, introduced in Spring Batch 3.0, is similar to `Step` scope in configuration but is a Scope for the `Job` context, so that there is only one instance of such a bean per running job. Additionally, support is provided for late binding of references accessible from the `JobContext` using `#{..}` placeholders. Using this feature, bean properties can be pulled from the job or job execution context and the job parameters, as shown in the following examples:

XML Configuration

```
<bean id="..." class="..." scope="job">
  <property name="name" value="#{jobParameters[input]}" />
</bean>
```

XML Configuration

```
<bean id="..." class="..." scope="job">
  <property name="name" value="#{jobExecutionContext['input.name']}.txt" />
</bean>
```

Java Configuration

```
@JobScope
@Bean
public FlatFileItemReader flatFileItemReader(@Value("#{jobParameters[input]}") String
name) {
    return new FlatFileItemReaderBuilder<Foo>()
        .name("flatFileItemReader")
        .resource(new FileSystemResource(name))
        ...
}
```

Java Configuration

```
@JobScope
@Bean
public FlatFileItemReader flatFileItemReader(@Value(
    "#{jobExecutionContext['input.name']}") String name) {
    return new FlatFileItemReaderBuilder<Foo>()
        .name("flatFileItemReader")
        .resource(new FileSystemResource(name))
        ...
}
```

Because it is not part of the Spring container by default, the scope must be added explicitly, by using the `batch` namespace, by including a bean definition explicitly for the JobScope, or using the `@EnableBatchProcessing` annotation (but not all of them). The following example uses the `batch` namespace:

```
<beans xmlns="http://www.springframework.org/schema/beans"
       xmlns:batch="http://www.springframework.org/schema/batch"
       xmlns:xsi="http://www.w3.org/2001/XMLSchema-instance"
       xsi:schemaLocation="...">

<batch:job .../>
...
</beans>
```

The following example includes a bean that explicitly defines the `JobScope`:

```
<bean class="org.springframework.batch.core.scope.JobScope" />
```

Chapter 6. ItemReaders and ItemWriters

All batch processing can be described in its most simple form as reading in large amounts of data, performing some type of calculation or transformation, and writing the result out. Spring Batch provides three key interfaces to help perform bulk reading and writing: `ItemReader`, `ItemProcessor`, and `ItemWriter`.

6.1. ItemReader

Although a simple concept, an `ItemReader` is the means for providing data from many different types of input. The most general examples include:

- Flat File: Flat-file item readers read lines of data from a flat file that typically describes records with fields of data defined by fixed positions in the file or delimited by some special character (such as a comma).
- XML: XML `ItemReaders` process XML independently of technologies used for parsing, mapping and validating objects. Input data allows for the validation of an XML file against an XSD schema.
- Database: A database resource is accessed to return resultsets which can be mapped to objects for processing. The default SQL `ItemReader` implementations invoke a `RowMapper` to return objects, keep track of the current row if restart is required, store basic statistics, and provide some transaction enhancements that are explained later.

There are many more possibilities, but we focus on the basic ones for this chapter. A complete list of all available `ItemReader` implementations can be found in [Appendix A](#).

`ItemReader` is a basic interface for generic input operations, as shown in the following interface definition:

```
public interface ItemReader<T> {  
  
    T read() throws Exception, UnexpectedInputException, ParseException,  
    NonTransientResourceException;  
  
}
```

The `read` method defines the most essential contract of the `ItemReader`. Calling it returns one item or `null` if no more items are left. An item might represent a line in a file, a row in a database, or an element in an XML file. It is generally expected that these are mapped to a usable domain object (such as `Trade`, `Foo`, or others), but there is no requirement in the contract to do so.

It is expected that implementations of the `ItemReader` interface are forward only. However, if the underlying resource is transactional (such as a JMS queue) then calling `read` may return the same logical item on subsequent calls in a rollback scenario. It is also worth noting that a lack of items to process by an `ItemReader` does not cause an exception to be thrown. For example, a database `ItemReader` that is configured with a query that returns 0 results returns `null` on the first invocation

of read.

6.2. ItemWriter

`ItemWriter` is similar in functionality to an `ItemReader` but with inverse operations. Resources still need to be located, opened, and closed but they differ in that an `ItemWriter` writes out, rather than reading in. In the case of databases or queues, these operations may be inserts, updates, or sends. The format of the serialization of the output is specific to each batch job.

As with `ItemReader`, `ItemWriter` is a fairly generic interface, as shown in the following interface definition:

```
public interface ItemWriter<T> {  
  
    void write(List<? extends T> items) throws Exception;  
  
}
```

As with `read` on `ItemReader`, `write` provides the basic contract of `ItemWriter`. It attempts to write out the list of items passed in as long as it is open. Because it is generally expected that items are 'batched' together into a chunk and then output, the interface accepts a list of items, rather than an item by itself. After writing out the list, any flushing that may be necessary can be performed before returning from the write method. For example, if writing to a Hibernate DAO, multiple calls to write can be made, one for each item. The writer can then call `flush` on the hibernate session before returning.

6.3. ItemProcessor

The `ItemReader` and `ItemWriter` interfaces are both very useful for their specific tasks, but what if you want to insert business logic before writing? One option for both reading and writing is to use the composite pattern: Create an `ItemWriter` that contains another `ItemWriter` or an `ItemReader` that contains another `ItemReader`. The following code shows an example:

```

public class CompositeItemWriter<T> implements ItemWriter<T> {

    ItemWriter<T> itemWriter;

    public CompositeItemWriter(ItemWriter<T> itemWriter) {
        this.itemWriter = itemWriter;
    }

    public void write(List<? extends T> items) throws Exception {
        //Add business logic here
        itemWriter.write(items);
    }

    public void setDelegate(ItemWriter<T> itemWriter){
        this.itemWriter = itemWriter;
    }
}

```

The preceding class contains another `ItemWriter` to which it delegates after having provided some business logic. This pattern could easily be used for an `ItemReader` as well, perhaps to obtain more reference data based upon the input that was provided by the main `ItemReader`. It is also useful if you need to control the call to `write` yourself. However, if you only want to 'transform' the item passed in for writing before it is actually written, you need not `write` yourself. You can just modify the item. For this scenario, Spring Batch provides the `ItemProcessor` interface, as shown in the following interface definition:

```

public interface ItemProcessor<I, O> {

    O process(I item) throws Exception;
}

```

An `ItemProcessor` is simple. Given one object, transform it and return another. The provided object may or may not be of the same type. The point is that business logic may be applied within the process, and it is completely up to the developer to create that logic. An `ItemProcessor` can be wired directly into a step. For example, assume an `ItemReader` provides a class of type `Foo` and that it needs to be converted to type `Bar` before being written out. The following example shows an `ItemProcessor` that performs the conversion:

```

public class Foo {}

public class Bar {
    public Bar(Foo foo) {}
}

public class FooProcessor implements ItemProcessor<Foo,Bar>{
    public Bar process(Foo foo) throws Exception {
        //Perform simple transformation, convert a Foo to a Bar
        return new Bar(foo);
    }
}

public class BarWriter implements ItemWriter<Bar>{
    public void write(List<? extends Bar> bars) throws Exception {
        //write bars
    }
}

```

In the preceding example, there is a class `Foo`, a class `Bar`, and a class `FooProcessor` that adheres to the `ItemProcessor` interface. The transformation is simple, but any type of transformation could be done here. The `BarWriter` writes `Bar` objects, throwing an exception if any other type is provided. Similarly, the `FooProcessor` throws an exception if anything but a `Foo` is provided. The `FooProcessor` can then be injected into a `Step`, as shown in the following example:

XML Configuration

```

<job id="ioSampleJob">
  <step name="step1">
    <tasklet>
      <chunk reader="fooReader" processor="fooProcessor" writer="barWriter"
        commit-interval="2"/>
    </tasklet>
  </step>
</job>

```

```
@Bean
public Job ioSampleJob() {
    return this.jobBuilderFactory.get("ioSampleJob")
        .start(step1())
        .end()
        .build();
}

@Bean
public Step step1() {
    return this.stepBuilderFactory.get("step1")
        .<String, String>chunk(2)
        .reader(fooReader())
        .processor(fooProcessor())
        .writer(barWriter())
        .build();
}
```

6.3.1. Chaining ItemProcessors

Performing a single transformation is useful in many scenarios, but what if you want to 'chain' together multiple `ItemProcessor` implementations? This can be accomplished using the composite pattern mentioned previously. To update the previous, single transformation, example, `Foo` is transformed to `Bar`, which is transformed to `Foobar` and written out, as shown in the following example:

```

public class Foo {}

public class Bar {
    public Bar(Foo foo) {}
}

public class Foobar {
    public Foobar(Bar bar) {}
}

public class FooProcessor implements ItemProcessor<Foo,Bar>{
    public Bar process(Foo foo) throws Exception {
        //Perform simple transformation, convert a Foo to a Bar
        return new Bar(foo);
    }
}

public class BarProcessor implements ItemProcessor<Bar,Foobar>{
    public Foobar process(Bar bar) throws Exception {
        return new Foobar(bar);
    }
}

public class FoobarWriter implements ItemWriter<Foobar>{
    public void write(List<? extends Foobar> items) throws Exception {
        //write items
    }
}

```

A **FooProcessor** and a **BarProcessor** can be 'chained' together to give the resultant **Foobar**, as shown in the following example:

```

CompositeItemProcessor<Foo,Foobar> compositeProcessor =
    new CompositeItemProcessor<Foo,Foobar>();
List itemProcessors = new ArrayList();
itemProcessors.add(new FooTransformer());
itemProcessors.add(new BarTransformer());
compositeProcessor.setDelegates(itemProcessors);

```

Just as with the previous example, the composite processor can be configured into the **Step**:

XML Configuration

```
<job id="ioSampleJob">
  <step name="step1">
    <tasklet>
      <chunk reader="fooReader" processor="compositeItemProcessor" writer=
"foobarWriter"
              commit-interval="2"/>
    </tasklet>
  </step>
</job>

<bean id="compositeItemProcessor"
      class="org.springframework.batch.item.support.CompositeItemProcessor">
  <property name="delegates">
    <list>
      <bean class="..FooProcessor" />
      <bean class="..BarProcessor" />
    </list>
  </property>
</bean>
```

```

@Bean
public Job ioSampleJob() {
    return this.jobBuilderFactory.get("ioSampleJob")
        .start(step1())
        .end()
        .build();
}

@Bean
public Step step1() {
    return this.stepBuilderFactory.get("step1")
        .<String, String>chunk(2)
        .reader(fooReader())
        .processor(compositeProcessor())
        .writer(foobarWriter())
        .build();
}

@Bean
public CompositeItemProcessor compositeProcessor() {
    List<ItemProcessor> delegates = new ArrayList<>(2);
    delegates.add(new FooProcessor());
    delegates.add(new BarProcessor());

    CompositeItemProcessor processor = new CompositeItemProcessor();

    processor.setDelegates(delegates);

    return processor;
}

```

6.3.2. Filtering Records

One typical use for an item processor is to filter out records before they are passed to the `ItemWriter`. Filtering is an action distinct from skipping. Skipping indicates that a record is invalid, while filtering simply indicates that a record should not be written.

For example, consider a batch job that reads a file containing three different types of records: records to insert, records to update, and records to delete. If record deletion is not supported by the system, then we would not want to send any "delete" records to the `ItemWriter`. But, since these records are not actually bad records, we would want to filter them out rather than skip them. As a result, the `ItemWriter` would receive only "insert" and "update" records.

To filter a record, you can return `null` from the `ItemProcessor`. The framework detects that the result is `null` and avoids adding that item to the list of records delivered to the `ItemWriter`. As usual, an exception thrown from the `ItemProcessor` results in a skip.

6.3.3. Fault Tolerance

When a chunk is rolled back, items that have been cached during reading may be reprocessed. If a step is configured to be fault tolerant (typically by using skip or retry processing), any `ItemProcessor` used should be implemented in a way that is idempotent. Typically that would consist of performing no changes on the input item for the `ItemProcessor` and only updating the instance that is the result.

6.4. `ItemStream`

Both `ItemReaders` and `ItemWriters` serve their individual purposes well, but there is a common concern among both of them that necessitates another interface. In general, as part of the scope of a batch job, readers and writers need to be opened, closed, and require a mechanism for persisting state. The `ItemStream` interface serves that purpose, as shown in the following example:

```
public interface ItemStream {  
  
    void open(ExecutionContext executionContext) throws ItemStreamException;  
  
    void update(ExecutionContext executionContext) throws ItemStreamException;  
  
    void close() throws ItemStreamException;  
}
```

Before describing each method, we should mention the `ExecutionContext`. Clients of an `ItemReader` that also implement `ItemStream` should call `open` before any calls to `read`, in order to open any resources such as files or to obtain connections. A similar restriction applies to an `ItemWriter` that implements `ItemStream`. As mentioned in Chapter 2, if expected data is found in the `ExecutionContext`, it may be used to start the `ItemReader` or `ItemWriter` at a location other than its initial state. Conversely, `close` is called to ensure that any resources allocated during open are released safely. `update` is called primarily to ensure that any state currently being held is loaded into the provided `ExecutionContext`. This method is called before committing, to ensure that the current state is persisted in the database before commit.

In the special case where the client of an `ItemStream` is a `Step` (from the Spring Batch Core), an `ExecutionContext` is created for each `StepExecution` to allow users to store the state of a particular execution, with the expectation that it is returned if the same `JobInstance` is started again. For those familiar with Quartz, the semantics are very similar to a Quartz `JobDataMap`.

6.5. The Delegate Pattern and Registering with the Step

Note that the `CompositeItemWriter` is an example of the delegation pattern, which is common in Spring Batch. The delegates themselves might implement callback interfaces, such as `StepListener`. If they do and if they are being used in conjunction with Spring Batch Core as part of a `Step` in a `Job`, then they almost certainly need to be registered manually with the `Step`. A reader, writer, or processor that is directly wired into the `Step` gets registered automatically if it implements `ItemStream` or a `StepListener` interface. However, because the delegates are not known to the `Step`,

they need to be injected as listeners or streams (or both if appropriate), as shown in the following example:

XML Configuration

```
<job id="ioSampleJob">
  <step name="step1">
    <tasklet>
      <chunk reader="fooReader" processor="fooProcessor" writer=
"compositeItemWriter"
        commit-interval="2">
        <streams>
          <stream ref="barWriter" />
        </streams>
      </chunk>
    </tasklet>
  </step>
</job>

<bean id="compositeItemWriter" class="...CustomCompositeItemWriter">
  <property name="delegate" ref="barWriter" />
</bean>

<bean id="barWriter" class="...BarWriter" />
```



```

@Bean
public Job ioSampleJob() {
    return this.jobBuilderFactory.get("ioSampleJob")
        .start(step1())
        .end()
        .build();
}

@Bean
public Step step1() {
    return this.stepBuilderFactory.get("step1")
        .<String, String>chunk(2)
        .reader(fooReader())
        .processor(fooProcessor())
        .writer(compositeItemWriter())
        .stream(barWriter())
        .build();
}

@Bean
public CustomCompositeItemWriter compositeItemWriter() {

    CustomCompositeItemWriter writer = new CustomCompositeItemWriter();

    writer.setDelegate(barWriter());

    return writer;
}

@Bean
public BarWriter barWriter() {
    return new BarWriter();
}

```

6.6. Flat Files

One of the most common mechanisms for interchanging bulk data has always been the flat file. Unlike XML, which has an agreed upon standard for defining how it is structured (XSD), anyone reading a flat file must understand ahead of time exactly how the file is structured. In general, all flat files fall into two types: delimited and fixed length. Delimited files are those in which fields are separated by a delimiter, such as a comma. Fixed Length files have fields that are a set length.

6.6.1. The `FieldSet`

When working with flat files in Spring Batch, regardless of whether it is for input or output, one of the most important classes is the `FieldSet`. Many architectures and libraries contain abstractions for helping you read in from a file, but they usually return a `String` or an array of `String` objects.

This really only gets you halfway there. A `FieldSet` is Spring Batch's abstraction for enabling the binding of fields from a file resource. It allows developers to work with file input in much the same way as they would work with database input. A `FieldSet` is conceptually similar to a JDBC `ResultSet`. A `FieldSet` requires only one argument: a `String` array of tokens. Optionally, you can also configure the names of the fields so that the fields may be accessed either by index or name as patterned after `ResultSet`, as shown in the following example:

```
String[] tokens = new String[]{"foo", "1", "true"};
FieldSet fs = new DefaultFieldSet(tokens);
String name = fs.readString(0);
int value = fs.readInt(1);
boolean booleanValue = fs.readBoolean(2);
```

There are many more options on the `FieldSet` interface, such as `Date`, `long`, `BigDecimal`, and so on. The biggest advantage of the `FieldSet` is that it provides consistent parsing of flat file input. Rather than each batch job parsing differently in potentially unexpected ways, it can be consistent, both when handling errors caused by a format exception, or when doing simple data conversions.

6.6.2. FlatFileItemReader

A flat file is any type of file that contains at most two-dimensional (tabular) data. Reading flat files in the Spring Batch framework is facilitated by the class called `FlatFileItemReader`, which provides basic functionality for reading and parsing flat files. The two most important required dependencies of `FlatFileItemReader` are `Resource` and `LineMapper`. The `LineMapper` interface is explored more in the next sections. The resource property represents a Spring Core `Resource`. Documentation explaining how to create beans of this type can be found in [Spring Framework, Chapter 5. Resources](#). Therefore, this guide does not go into the details of creating `Resource` objects beyond showing the following simple example:

```
Resource resource = new FileSystemResource("resources/trades.csv");
```

In complex batch environments, the directory structures are often managed by the EAI infrastructure, where drop zones for external interfaces are established for moving files from FTP locations to batch processing locations and vice versa. File moving utilities are beyond the scope of the Spring Batch architecture, but it is not unusual for batch job streams to include file moving utilities as steps in the job stream. The batch architecture only needs to know how to locate the files to be processed. Spring Batch begins the process of feeding the data into the pipe from this starting point. However, [Spring Integration](#) provides many of these types of services.

The other properties in `FlatFileItemReader` let you further specify how your data is interpreted, as described in the following table:

Table 15. `FlatFileItemReader` Properties

Property	Type	Description
comments	String[]	Specifies line prefixes that indicate comment rows.

Property	Type	Description
encoding	String	Specifies what text encoding to use. The default is the value of <code>Charset.defaultCharset()</code> .
lineMapper	LineMapper	Converts a <code>String</code> to an <code>Object</code> representing the item.
linesToSkip	int	Number of lines to ignore at the top of the file.
recordSeparatorPolicy	RecordSeparatorPolicy	Used to determine where the line endings are and do things like continue over a line ending if inside a quoted string.
resource	Resource	The resource from which to read.
skippedLinesCallback	LineCallbackHandler	Interface that passes the raw line content of the lines in the file to be skipped. If <code>linesToSkip</code> is set to 2, then this interface is called twice.
strict	boolean	In strict mode, the reader throws an exception on <code>ExecutionContext</code> if the input resource does not exist. Otherwise, it logs the problem and continues.

LineMapper

As with `RowMapper`, which takes a low-level construct such as `ResultSet` and returns an `Object`, flat file processing requires the same construct to convert a `String` line into an `Object`, as shown in the following interface definition:

```
public interface LineMapper<T> {
    T mapLine(String line, int lineNumber) throws Exception;
}
```

The basic contract is that, given the current line and the line number with which it is associated, the mapper should return a resulting domain object. This is similar to `RowMapper`, in that each line is associated with its line number, just as each row in a `ResultSet` is tied to its row number. This allows the line number to be tied to the resulting domain object for identity comparison or for more informative logging. However, unlike `RowMapper`, the `LineMapper` is given a raw line which, as discussed above, only gets you halfway there. The line must be tokenized into a `FieldSet`, which can then be mapped to an object, as described later in this document.

LineTokenizer

An abstraction for turning a line of input into a `FieldSet` is necessary because there can be many formats of flat file data that need to be converted to a `FieldSet`. In Spring Batch, this interface is the `LineTokenizer`:

```
public interface LineTokenizer {  
  
    FieldSet tokenize(String line);  
  
}
```

The contract of a `LineTokenizer` is such that, given a line of input (in theory the `String` could encompass more than one line), a `FieldSet` representing the line is returned. This `FieldSet` can then be passed to a `FieldSetMapper`. Spring Batch contains the following `LineTokenizer` implementations:

- `DelimitedLineTokenizer`: Used for files where fields in a record are separated by a delimiter. The most common delimiter is a comma, but pipes or semicolons are often used as well.
- `FixedLengthTokenizer`: Used for files where fields in a record are each a "fixed width". The width of each field must be defined for each record type.
- `PatternMatchingCompositeLineTokenizer`: Determines which `LineTokenizer` among a list of tokenizers should be used on a particular line by checking against a pattern.

FieldSetMapper

The `FieldSetMapper` interface defines a single method, `mapFieldSet`, which takes a `FieldSet` object and maps its contents to an object. This object may be a custom DTO, a domain object, or an array, depending on the needs of the job. The `FieldSetMapper` is used in conjunction with the `LineTokenizer` to translate a line of data from a resource into an object of the desired type, as shown in the following interface definition:

```
public interface FieldSetMapper<T> {  
  
    T mapFieldSet(FieldSet fieldSet) throws BindException;  
  
}
```

The pattern used is the same as the `RowMapper` used by `JdbcTemplate`.

DefaultLineMapper

Now that the basic interfaces for reading in flat files have been defined, it becomes clear that three basic steps are required:

1. Read one line from the file.
2. Pass the `String` line into the `LineTokenizer#tokenize()` method to retrieve a `FieldSet`.
3. Pass the `FieldSet` returned from tokenizing to a `FieldSetMapper`, returning the result from the

`ItemReader#read()` method.

The two interfaces described above represent two separate tasks: converting a line into a `FieldSet` and mapping a `FieldSet` to a domain object. Because the input of a `LineTokenizer` matches the input of the `LineMapper` (a line), and the output of a `FieldSetMapper` matches the output of the `LineMapper`, a default implementation that uses both a `LineTokenizer` and a `FieldSetMapper` is provided. The `DefaultLineMapper`, shown in the following class definition, represents the behavior most users need:

```
public class DefaultLineMapper<T> implements LineMapper<>, InitializingBean {  
  
    private LineTokenizer tokenizer;  
  
    private FieldSetMapper<T> fieldSetMapper;  
  
    public T mapLine(String line, int lineNumber) throws Exception {  
        return fieldSetMapper.mapFieldSet(tokenizer.tokenize(line));  
    }  
  
    public void setLineTokenizer(LineTokenizer tokenizer) {  
        this.tokenizer = tokenizer;  
    }  
  
    public void setFieldSetMapper(FieldSetMapper<T> fieldSetMapper) {  
        this.fieldSetMapper = fieldSetMapper;  
    }  
}
```

The above functionality is provided in a default implementation, rather than being built into the reader itself (as was done in previous versions of the framework) to allow users greater flexibility in controlling the parsing process, especially if access to the raw line is needed.

Simple Delimited File Reading Example

The following example illustrates how to read a flat file with an actual domain scenario. This particular batch job reads in football players from the following file:

```
ID,lastName,firstName,position,birthYear,debutYear  
"AbduKa00,Abdul-Jabbar,Karim,rb,1974,1996",  
"AbduRa00,Abdullah,Rabih,rb,1975,1999",  
"AberWa00,Abercrombie,Walter,rb,1959,1982",  
"AbraDa00,Abramowicz,Danny,wr,1945,1967",  
"AdamBo00,Adams,Bob,te,1946,1969",  
"AdamCh00,Adams,Charlie,wr,1979,2003"
```

The contents of this file are mapped to the following `Player` domain object:

```

public class Player implements Serializable {

    private String ID;
    private String lastName;
    private String firstName;
    private String position;
    private int birthYear;
    private int debutYear;

    public String toString() {
        return "PLAYER:ID=" + ID + ",Last Name=" + lastName +
            ",First Name=" + firstName + ",Position=" + position +
            ",Birth Year=" + birthYear + ",DebutYear=" +
            debutYear;
    }

    // setters and getters...
}

```

To map a `FieldSet` into a `Player` object, a `FieldSetMapper` that returns players needs to be defined, as shown in the following example:

```

protected static class PlayerFieldSetMapper implements FieldSetMapper<Player> {
    public Player mapFieldSet(FieldSet fieldSet) {
        Player player = new Player();

        player.setID(fieldSet.readString(0));
        player.setLastName(fieldSet.readString(1));
        player.setFirstName(fieldSet.readString(2));
        player.setPosition(fieldSet.readString(3));
        player.setBirthYear(fieldSet.readInt(4));
        player.setDebutYear(fieldSet.readInt(5));

        return player;
    }
}

```

The file can then be read by correctly constructing a `FlatFileItemReader` and calling `read`, as shown in the following example:

```

FlatFileItemReader<Player> itemReader = new FlatFileItemReader<>();
itemReader.setResource(new FileSystemResource("resources/players.csv"));
//DelimitedLineTokenizer defaults to comma as its delimiter
DefaultLineMapper<Player> lineMapper = new DefaultLineMapper<>();
lineMapper.setLineTokenizer(new DelimitedLineTokenizer());
lineMapper.setFieldSetMapper(new PlayerFieldSetMapper());
itemReader.setLineMapper(lineMapper);
itemReader.open(new ExecutionContext());
Player player = itemReader.read();

```

Each call to `read` returns a new `Player` object from each line in the file. When the end of the file is reached, `null` is returned.

Mapping Fields by Name

There is one additional piece of functionality that is allowed by both `DelimitedLineTokenizer` and `FixedLengthTokenizer` and that is similar in function to a JDBC `ResultSet`. The names of the fields can be injected into either of these `LineTokenizer` implementations to increase the readability of the mapping function. First, the column names of all fields in the flat file are injected into the tokenizer, as shown in the following example:

```

tokenizer.setNames(new String[] {"ID", "lastName", "firstName", "position", "birthYear",
"debutYear"});

```

A `FieldSetMapper` can use this information as follows:

```

public class PlayerMapper implements FieldSetMapper<Player> {
    public Player mapFieldSet(FieldSet fs) {

        if(fs == null){
            return null;
        }

        Player player = new Player();
        player.setID(fs.readString("ID"));
        player.setLastName(fs.readString("lastName"));
        player.setFirstName(fs.readString("firstName"));
        player.setPosition(fs.readString("position"));
        player.setDebutYear(fs.readInt("debutYear"));
        player.setBirthYear(fs.readInt("birthYear"));

        return player;
    }
}

```

Automapping FieldSets to Domain Objects

For many, having to write a specific `FieldSetMapper` is equally as cumbersome as writing a specific `RowMapper` for a `JdbcTemplate`. Spring Batch makes this easier by providing a `FieldSetMapper` that automatically maps fields by matching a field name with a setter on the object using the JavaBean specification. Again using the football example, the `BeanWrapperFieldSetMapper` configuration looks like the following snippet:

XML Configuration

```
<bean id="fieldSetMapper"
      class="org.springframework.batch.item.file.mapping.BeanWrapperFieldSetMapper">
  <property name="prototypeBeanName" value="player" />
</bean>

<bean id="player"
      class="org.springframework.batch.sample.domain.Player"
      scope="prototype" />
```

Java Configuration

```
@Bean
public FieldSetMapper fieldSetMapper() {
    BeanWrapperFieldSetMapper fieldSetMapper = new BeanWrapperFieldSetMapper();

    fieldSetMapper.setPrototypeBeanName("player");

    return fieldSetMapper;
}

@Bean
@Scope("prototype")
public Player player() {
    return new Player();
}
```

For each entry in the `FieldSet`, the mapper looks for a corresponding setter on a new instance of the `Player` object (for this reason, prototype scope is required) in the same way the Spring container looks for setters matching a property name. Each available field in the `FieldSet` is mapped, and the resultant `Player` object is returned, with no code required.

Fixed Length File Formats

So far, only delimited files have been discussed in much detail. However, they represent only half of the file reading picture. Many organizations that use flat files use fixed length formats. An example fixed length file follows:

```
UK21341EAH4121131.11customer1
UK21341EAH4221232.11customer2
UK21341EAH4321333.11customer3
UK21341EAH4421434.11customer4
UK21341EAH4521535.11customer5
```

While this looks like one large field, it actually represent 4 distinct fields:

1. ISIN: Unique identifier for the item being ordered - 12 characters long.
2. Quantity: Number of the item being ordered - 3 characters long.
3. Price: Price of the item - 5 characters long.
4. Customer: ID of the customer ordering the item - 9 characters long.

When configuring the `FixedLengthLineTokenizer`, each of these lengths must be provided in the form of ranges, as shown in the following example:

XML Configuration

```
<bean id="fixedLengthLineTokenizer"
      class="org.springframework.batch.io.file.transform.FixedLengthTokenizer">
  <property name="names" value="ISIN,Quantity,Price,Customer" />
  <property name="columns" value="1-12, 13-15, 16-20, 21-29" />
</bean>
```

Because the `FixedLengthLineTokenizer` uses the same `LineTokenizer` interface as discussed above, it returns the same `FieldSet` as if a delimiter had been used. This allows the same approaches to be used in handling its output, such as using the `BeanWrapperFieldSetMapper`.



Supporting the above syntax for ranges requires that a specialized property editor, `RangeArrayPropertyEditor`, be configured in the `ApplicationContext`. However, this bean is automatically declared in an `ApplicationContext` where the batch namespace is used.

```
@Bean
public FixedLengthTokenizer fixedLengthTokenizer() {
    FixedLengthTokenizer tokenizer = new FixedLengthTokenizer();

    tokenizer.setNames("ISIN", "Quantity", "Price", "Customer");
    tokenizer.setColumns(new Range(1-12),
        new Range(13-15),
        new Range(16-20),
        new Range(21-29));

    return tokenizer;
}
```

Because the `FixedLengthLineTokenizer` uses the same `LineTokenizer` interface as discussed above, it returns the same `FieldSet` as if a delimiter had been used. This lets the same approaches be used in handling its output, such as using the `BeanWrapperFieldSetMapper`.

Multiple Record Types within a Single File

All of the file reading examples up to this point have all made a key assumption for simplicity's sake: all of the records in a file have the same format. However, this may not always be the case. It is very common that a file might have records with different formats that need to be tokenized differently and mapped to different objects. The following excerpt from a file illustrates this:

```
USER;Smith;Peter;;T;20014539;F
LINEA;1044391041ABC037.49G201XX1383.12H
LINEB;2134776319DEF422.99M005LI
```

In this file we have three types of records, "USER", "LINEA", and "LINEB". A "USER" line corresponds to a `User` object. "LINEA" and "LINEB" both correspond to `Line` objects, though a "LINEA" has more information than a "LINEB".

The `ItemReader` reads each line individually, but we must specify different `LineTokenizer` and `FieldSetMapper` objects so that the `ItemWriter` receives the correct items. The `PatternMatchingCompositeLineMapper` makes this easy by allowing maps of patterns to `LineTokenizer` instances and patterns to `FieldSetMapper` instances to be configured, as shown in the following example:

XML Configuration

```
<bean id="orderFileLineMapper"
      class="org.spr...PatternMatchingCompositeLineMapper">
  <property name="tokenizers">
    <map>
      <entry key="USER*" value-ref="userTokenizer" />
      <entry key="LINEA*" value-ref="lineATokenizer" />
      <entry key="LINEB*" value-ref="lineBTokenizer" />
    </map>
  </property>
  <property name="fieldSetMappers">
    <map>
      <entry key="USER*" value-ref="userFieldSetMapper" />
      <entry key="LINE*" value-ref="lineFieldSetMapper" />
    </map>
  </property>
</bean>
```

Java Configuration

```
@Bean
public PatternMatchingCompositeLineMapper orderFileLineMapper() {
    PatternMatchingCompositeLineMapper lineMapper =
        new PatternMatchingCompositeLineMapper();

    Map<String, LineTokenizer> tokenizers = new HashMap<>(3);
    tokenizers.put("USER*", userTokenizer());
    tokenizers.put("LINEA*", lineATokenizer());
    tokenizers.put("LINEB*", lineBTokenizer());

    lineMapper.setTokenizers(tokenizers);

    Map<String, FieldSetMapper> mappers = new HashMap<>(2);
    mappers.put("USER*", userFieldSetMapper());
    mappers.put("LINE*", lineFieldSetMapper());

    lineMapper.setFieldSetMappers(mappers);

    return lineMapper;
}
```

In this example, "LINEA" and "LINEB" have separate `LineTokenizer` instances, but they both use the same `FieldSetMapper`.

The `PatternMatchingCompositeLineMapper` uses the `PatternMatcher#match` method in order to select the correct delegate for each line. The `PatternMatcher` allows for two wildcard characters with special meaning: the question mark ("?") matches exactly one character, while the asterisk ("*") matches zero or more characters. Note that, in the preceding configuration, all patterns end with an asterisk,

making them effectively prefixes to lines. The `PatternMatcher` always matches the most specific pattern possible, regardless of the order in the configuration. So if "LINE*" and "LINEA*" were both listed as patterns, "LINEA" would match pattern "LINEA*", while "LINEB" would match pattern "LINE*". Additionally, a single asterisk ("*") can serve as a default by matching any line not matched by any other pattern, as shown in the following example.

XML Configuration

```
<entry key="*" value-ref="defaultLineTokenizer" />
```

Java Configuration

```
...  
tokenizers.put("*", defaultLineTokenizer());  
...
```

There is also a `PatternMatchingCompositeLineTokenizer` that can be used for tokenization alone.

It is also common for a flat file to contain records that each span multiple lines. To handle this situation, a more complex strategy is required. A demonstration of this common pattern can be found in the `multiLineRecords` sample.

Exception Handling in Flat Files

There are many scenarios when tokenizing a line may cause exceptions to be thrown. Many flat files are imperfect and contain incorrectly formatted records. Many users choose to skip these erroneous lines while logging the issue, the original line, and the line number. These logs can later be inspected manually or by another batch job. For this reason, Spring Batch provides a hierarchy of exceptions for handling parse exceptions: `FlatFileParseException` and `FlatFileFormatException`. `FlatFileParseException` is thrown by the `FlatFileItemReader` when any errors are encountered while trying to read a file. `FlatFileFormatException` is thrown by implementations of the `LineTokenizer` interface and indicates a more specific error encountered while tokenizing.

`IncorrectTokenCountException`

Both `DelimitedLineTokenizer` and `FixedLengthLineTokenizer` have the ability to specify column names that can be used for creating a `FieldSet`. However, if the number of column names does not match the number of columns found while tokenizing a line, the `FieldSet` cannot be created, and an `IncorrectTokenCountException` is thrown, which contains the number of tokens encountered, and the number expected, as shown in the following example:

```

tokenizer.setNames(new String[] {"A", "B", "C", "D"});

try {
    tokenizer.tokenize("a,b,c");
}
catch(IncorrectTokenCountException e){
    assertEquals(4, e.getExpectedCount());
    assertEquals(3, e.getActualCount());
}

```

Because the tokenizer was configured with 4 column names but only 3 tokens were found in the file, an `IncorrectTokenCountException` was thrown.

`IncorrectLineLengthException`

Files formatted in a fixed-length format have additional requirements when parsing because, unlike a delimited format, each column must strictly adhere to its predefined width. If the total line length does not equal the widest value of this column, an exception is thrown, as shown in the following example:

```

tokenizer.setColumns(new Range[] { new Range(1, 5),
                                   new Range(6, 10),
                                   new Range(11, 15) });

try {
    tokenizer.tokenize("12345");
    fail("Expected IncorrectLineLengthException");
}
catch (IncorrectLineLengthException ex) {
    assertEquals(15, ex.getExpectedLength());
    assertEquals(5, ex.getActualLength());
}

```

The configured ranges for the tokenizer above are: 1-5, 6-10, and 11-15. Consequently, the total length of the line is 15. However, in the preceding example, a line of length 5 was passed in, causing an `IncorrectLineLengthException` to be thrown. Throwing an exception here rather than only mapping the first column allows the processing of the line to fail earlier and with more information than it would contain if it failed while trying to read in column 2 in a `FieldSetMapper`. However, there are scenarios where the length of the line is not always constant. For this reason, validation of line length can be turned off via the 'strict' property, as shown in the following example:

```

tokenizer.setColumns(new Range[] { new Range(1, 5), new Range(6, 10) });
tokenizer.setStrict(false);
FieldSet tokens = tokenizer.tokenize("12345");
assertEquals("12345", tokens.readString(0));
assertEquals("", tokens.readString(1));

```

The preceding example is almost identical to the one before it, except that

`tokenizer.setStrict(false)` was called. This setting tells the tokenizer to not enforce line lengths when tokenizing the line. A `FieldSet` is now correctly created and returned. However, it contains only empty tokens for the remaining values.

6.6.3. FlatFileItemWriter

Writing out to flat files has the same problems and issues that reading in from a file must overcome. A step must be able to write either delimited or fixed length formats in a transactional manner.

LineAggregator

Just as the `LineTokenizer` interface is necessary to take an item and turn it into a `String`, file writing must have a way to aggregate multiple fields into a single string for writing to a file. In Spring Batch, this is the `LineAggregator`, shown in the following interface definition:

```
public interface LineAggregator<T> {  
  
    public String aggregate(T item);  
  
}
```

The `LineAggregator` is the logical opposite of `LineTokenizer`. `LineTokenizer` takes a `String` and returns a `FieldSet`, whereas `LineAggregator` takes an `item` and returns a `String`.

PassThroughLineAggregator

The most basic implementation of the `LineAggregator` interface is the `PassThroughLineAggregator`, which assumes that the object is already a string or that its string representation is acceptable for writing, as shown in the following code:

```
public class PassThroughLineAggregator<T> implements LineAggregator<T> {  
  
    public String aggregate(T item) {  
        return item.toString();  
    }  
}
```

The preceding implementation is useful if direct control of creating the string is required but the advantages of a `FlatFileItemWriter`, such as transaction and restart support, are necessary.

Simplified File Writing Example

Now that the `LineAggregator` interface and its most basic implementation, `PassThroughLineAggregator`, have been defined, the basic flow of writing can be explained:

1. The object to be written is passed to the `LineAggregator` in order to obtain a `String`.
2. The returned `String` is written to the configured file.

The following excerpt from the `FlatFileItemWriter` expresses this in code:

```
public void write(T item) throws Exception {
    write(lineAggregator.aggregate(item) + LINE_SEPARATOR);
}
```

A simple configuration might look like the following:

XML Configuration

```
<bean id="itemWriter" class="org.spr...FlatFileItemWriter">
    <property name="resource" value="file:target/test-outputs/output.txt" />
    <property name="lineAggregator">
        <bean class="org.spr...PassThroughLineAggregator"/>
    </property>
</bean>
```

Java Configuration

```
@Bean
public FlatFileItemWriter itemWriter() {
    return new FlatFileItemWriterBuilder<Foo>()
        .name("itemWriter")
        .resource(new FileSystemResource("target/test-outputs/output.txt"
    ))
        .lineAggregator(new PassThroughLineAggregator<>())
        .build();
}
```

FieldExtractor

The preceding example may be useful for the most basic uses of a writing to a file. However, most users of the `FlatFileItemWriter` have a domain object that needs to be written out and, thus, must be converted into a line. In file reading, the following was required:

1. Read one line from the file.
2. Pass the line into the `LineTokenizer#tokenize()` method, in order to retrieve a `FieldSet`.
3. Pass the `FieldSet` returned from tokenizing to a `FieldSetMapper`, returning the result from the `ItemReader#read()` method.

File writing has similar but inverse steps:

1. Pass the item to be written to the writer.
2. Convert the fields on the item into an array.
3. Aggregate the resulting array into a line.

Because there is no way for the framework to know which fields from the object need to be written

out, a `FieldExtractor` must be written to accomplish the task of turning the item into an array, as shown in the following interface definition:

```
public interface FieldExtractor<T> {  
  
    Object[] extract(T item);  
  
}
```

Implementations of the `FieldExtractor` interface should create an array from the fields of the provided object, which can then be written out with a delimiter between the elements or as part of a fixed-width line.

`PassThroughFieldExtractor`

There are many cases where a collection, such as an array, `Collection`, or `FieldSet`, needs to be written out. "Extracting" an array from one of these collection types is very straightforward. To do so, convert the collection to an array. Therefore, the `PassThroughFieldExtractor` should be used in this scenario. It should be noted that, if the object passed in is not a type of collection, then the `PassThroughFieldExtractor` returns an array containing solely the item to be extracted.

`BeanWrapperFieldExtractor`

As with the `BeanWrapperFieldSetMapper` described in the file reading section, it is often preferable to configure how to convert a domain object to an object array, rather than writing the conversion yourself. The `BeanWrapperFieldExtractor` provides this functionality, as shown in the following example:

```
BeanWrapperFieldExtractor<Name> extractor = new BeanWrapperFieldExtractor<>();  
extractor.setNames(new String[] { "first", "last", "born" });  
  
String first = "Alan";  
String last = "Turing";  
int born = 1912;  
  
Name n = new Name(first, last, born);  
Object[] values = extractor.extract(n);  
  
assertEquals(first, values[0]);  
assertEquals(last, values[1]);  
assertEquals(born, values[2]);
```

This extractor implementation has only one required property: the names of the fields to map. Just as the `BeanWrapperFieldSetMapper` needs field names to map fields on the `FieldSet` to setters on the provided object, the `BeanWrapperFieldExtractor` needs names to map to getters for creating an object array. It is worth noting that the order of the names determines the order of the fields within the array.

Delimited File Writing Example

The most basic flat file format is one in which all fields are separated by a delimiter. This can be accomplished using a `DelimitedLineAggregator`. The following example writes out a simple domain object that represents a credit to a customer account:

```
public class CustomerCredit {  
  
    private int id;  
    private String name;  
    private BigDecimal credit;  
  
    //getters and setters removed for clarity  
}
```

Because a domain object is being used, an implementation of the `FieldExtractor` interface must be provided, along with the delimiter to use, as shown in the following example:

XML Configuration

```
<bean id="itemWriter" class="org.springframework.batch.item.file.FlatFileItemWriter">  
    <property name="resource" ref="outputResource" />  
    <property name="lineAggregator">  
        <bean class="org.spr...DelimitedLineAggregator">  
            <property name="delimiter" value="," />  
            <property name="fieldExtractor">  
                <bean class="org.spr...BeanWrapperFieldExtractor">  
                    <property name="names" value="name,credit" />  
                </bean>  
            </property>  
        </bean>  
    </property>  
</bean>  
</property>  
</bean>
```

```
@Bean
public FlatFileItemWriter<CustomerCredit> itemWriter(Resource outputResource) throws
Exception {
    BeanWrapperFieldExtractor<CustomerCredit> fieldExtractor = new
BeanWrapperFieldExtractor<>();
    fieldExtractor.setNames(new String[] {"name", "credit"});
    fieldExtractor.afterPropertiesSet();

    DelimitedLineAggregator<CustomerCredit> lineAggregator = new
DelimitedLineAggregator<>();
    lineAggregator.setDelimiter(",");
    lineAggregator.setFieldExtractor(fieldExtractor);

    return new FlatFileItemWriterBuilder<CustomerCredit>()
        .name("customerCreditWriter")
        .resource(outputResource)
        .lineAggregator(lineAggregator)
        .build();
}
```

In the previous example, the `BeanWrapperFieldExtractor` described earlier in this chapter is used to turn the name and credit fields within `CustomerCredit` into an object array, which is then written out with commas between each field.

It is also possible to use the `FlatFileItemWriterBuilder.DelimitedBuilder` to automatically create the `BeanWrapperFieldExtractor` and `DelimitedLineAggregator` as shown in the following example:

```
@Bean
public FlatFileItemWriter<CustomerCredit> itemWriter(Resource outputResource) throws
Exception {
    return new FlatFileItemWriterBuilder<CustomerCredit>()
        .name("customerCreditWriter")
        .resource(outputResource)
        .delimited()
        .delimiter("|")
        .names(new String[] {"name", "credit"})
        .build();
}
```

Fixed Width File Writing Example

Delimited is not the only type of flat file format. Many prefer to use a set width for each column to delineate between fields, which is usually referred to as 'fixed width'. Spring Batch supports this in file writing with the `FormatterLineAggregator`. Using the same `CustomerCredit` domain object described above, it can be configured as follows:

XML Configuration

```
<bean id="itemWriter" class="org.springframework.batch.item.file.FlatFileItemWriter">
  <property name="resource" ref="outputResource" />
  <property name="lineAggregator">
    <bean class="org.springframework.batch.item.file.FormatterLineAggregator">
      <property name="fieldExtractor">
        <bean class="org.springframework.batch.item.file.BeanWrapperFieldExtractor">
          <property name="names" value="name,credit" />
        </bean>
      </property>
      <property name="format" value="%-9s%-2.0f" />
    </bean>
  </property>
</bean>
```

Java Configuration

```
@Bean
public FlatFileItemWriter<CustomerCredit> itemWriter(Resource outputResource) throws
Exception {
    BeanWrapperFieldExtractor<CustomerCredit> fieldExtractor = new
BeanWrapperFieldExtractor<>();
    fieldExtractor.setNames(new String[] {"name", "credit"});
    fieldExtractor.afterPropertiesSet();

    FormatterLineAggregator<CustomerCredit> lineAggregator = new
FormatterLineAggregator<>();
    lineAggregator.setFormat("%-9s%-2.0f");
    lineAggregator.setFieldExtractor(fieldExtractor);

    return new FlatFileItemWriterBuilder<CustomerCredit>()
        .name("customerCreditWriter")
        .resource(outputResource)
        .lineAggregator(lineAggregator)
        .build();
}
```

Most of the preceding example should look familiar. However, the value of the format property is new and is shown in the following element:

```
<property name="format" value="%-9s%-2.0f" />
```

```

...
FormatterLineAggregator<CustomerCredit> lineAggregator = new FormatterLineAggregator<
>();
lineAggregator.setFormat("%-9s%-2.0f");
...

```

The underlying implementation is built using the same `Formatter` added as part of Java 5. The Java `Formatter` is based on the `printf` functionality of the C programming language. Most details on how to configure a formatter can be found in the Javadoc of `Formatter`.

It is also possible to use the `FlatFileItemWriterBuilder.FormattedBuilder` to automatically create the `BeanWrapperFieldExtractor` and `FormatterLineAggregator` as shown in following example:

Java Configuration

```

@Bean
public FlatFileItemWriter<CustomerCredit> itemWriter(Resource outputResource) throws
Exception {
    return new FlatFileItemWriterBuilder<CustomerCredit>()
        .name("customerCreditWriter")
        .resource(outputResource)
        .formatted()
        .format("%-9s%-2.0f")
        .names(new String[] {"name", "credit"})
        .build();
}

```

Handling File Creation

`FlatFileItemReader` has a very simple relationship with file resources. When the reader is initialized, it opens the file (if it exists), and throws an exception if it does not. File writing isn't quite so simple. At first glance, it seems like a similar straightforward contract should exist for `FlatFileItemWriter`: If the file already exists, throw an exception, and, if it does not, create it and start writing. However, potentially restarting a `Job` can cause issues. In normal restart scenarios, the contract is reversed: If the file exists, start writing to it from the last known good position, and, if it does not, throw an exception. However, what happens if the file name for this job is always the same? In this case, you would want to delete the file if it exists, unless it's a restart. Because of this possibility, the `FlatFileItemWriter` contains the property, `shouldDeleteIfExists`. Setting this property to true causes an existing file with the same name to be deleted when the writer is opened.

6.7. XML Item Readers and Writers

Spring Batch provides transactional infrastructure for both reading XML records and mapping them to Java objects as well as writing Java objects as XML records.

Constraints on streaming XML



The StAX API is used for I/O, as other standard XML parsing APIs do not fit batch processing requirements (DOM loads the whole input into memory at once and SAX controls the parsing process by allowing the user to provide only callbacks).

We need to consider how XML input and output works in Spring Batch. First, there are a few concepts that vary from file reading and writing but are common across Spring Batch XML processing. With XML processing, instead of lines of records (`FieldSet` instances) that need to be tokenized, it is assumed an XML resource is a collection of 'fragments' corresponding to individual records, as shown in the following image:

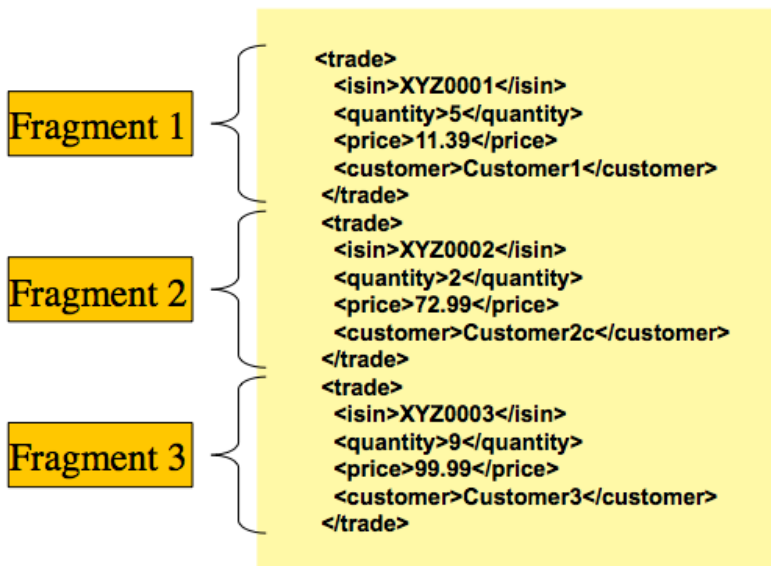

Figure 17. XML Input

The 'trade' tag is defined as the 'root element' in the scenario above. Everything between '<trade>' and '</trade>' is considered one 'fragment'. Spring Batch uses Object/XML Mapping (OXM) to bind fragments to objects. However, Spring Batch is not tied to any particular XML binding technology. Typical use is to delegate to [Spring OXM](#), which provides uniform abstraction for the most popular OXM technologies. The dependency on Spring OXM is optional and you can choose to implement Spring Batch specific interfaces if desired. The relationship to the technologies that OXM supports is shown in the following image:

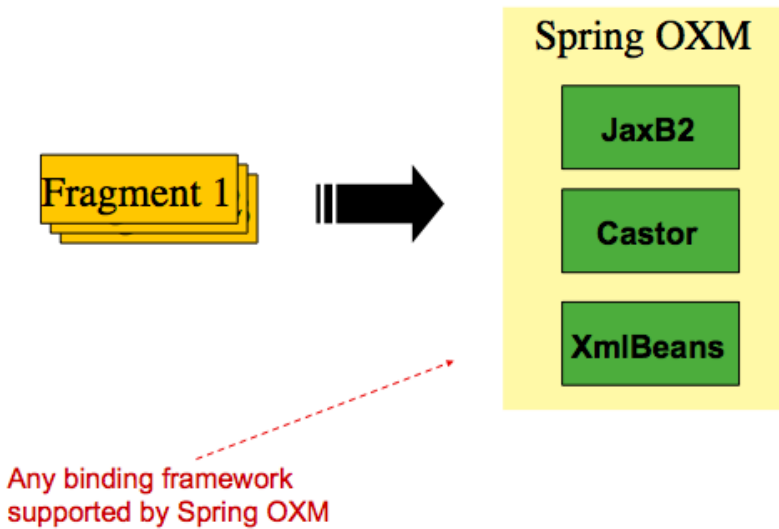

Figure 18. OXM Binding

With an introduction to OXM and how one can use XML fragments to represent records, we can now more closely examine readers and writers.

6.7.1. StaxEventItemReader

The `StaxEventItemReader` configuration provides a typical setup for the processing of records from an XML input stream. First, consider the following set of XML records that the `StaxEventItemReader` can process:

```
<?xml version="1.0" encoding="UTF-8"?>
<records>
  <trade xmlns="https://springframework.org/batch/sample/io/oxm/domain">
    <isin>XYZ0001</isin>
    <quantity>5</quantity>
    <price>11.39</price>
    <customer>Customer1</customer>
  </trade>
  <trade xmlns="https://springframework.org/batch/sample/io/oxm/domain">
    <isin>XYZ0002</isin>
    <quantity>2</quantity>
    <price>72.99</price>
    <customer>Customer2c</customer>
  </trade>
  <trade xmlns="https://springframework.org/batch/sample/io/oxm/domain">
    <isin>XYZ0003</isin>
    <quantity>9</quantity>
    <price>99.99</price>
    <customer>Customer3</customer>
  </trade>
</records>
```

To be able to process the XML records, the following is needed:

- Root Element Name: The name of the root element of the fragment that constitutes the object to

be mapped. The example configuration demonstrates this with the value of `trade`.

- **Resource**: A Spring Resource that represents the file to read.
- **Unmarshaller**: An unmarshalling facility provided by Spring OXM for mapping the XML fragment to an object.

The following example shows how to define a `StaxEventItemReader` that works with a root element named `trade`, a resource of `org/springframework/batch/item/xml/domain/trades.xml`, and an unmarshaller called `tradeMarshaller`.

XML Configuration

```
<bean id="itemReader" class="org.springframework.batch.item.xml.StaxEventItemReader">
  <property name="fragmentRootElementName" value="trade" />
  <property name="resource" value=
"org/springframework/batch/item/xml/domain/trades.xml" />
  <property name="unmarshaller" ref="tradeMarshaller" />
</bean>
```

Java Configuration

```
@Bean
public StaxEventItemReader itemReader() {
    return new StaxEventItemReaderBuilder<Trade>()
        .name("itemReader")
        .resource(new FileSystemResource(
"org/springframework/batch/item/xml/domain/trades.xml"))
        .addFragmentRootElement("trade")
        .unmarshaller(tradeMarshaller())
        .build();
}
```

Note that, in this example, we have chosen to use an `XStreamMarshaller`, which accepts an alias passed in as a map with the first key and value being the name of the fragment (that is, a root element) and the object type to bind. Then, similar to a `FieldSet`, the names of the other elements that map to fields within the object type are described as key/value pairs in the map. In the configuration file, we can use a Spring configuration utility to describe the required alias, as follows:

XML Configuration

```
<bean id="tradeMarshaller"
      class="org.springframework.xml.xstream.XStreamMarshaller">
  <property name="aliases">
    <util:map id="aliases">
      <entry key="trade"
            value="org.springframework.batch.sample.domain.trade.Trade" />
      <entry key="price" value="java.math.BigDecimal" />
      <entry key="isin" value="java.lang.String" />
      <entry key="customer" value="java.lang.String" />
      <entry key="quantity" value="java.lang.Long" />
    </util:map>
  </property>
</bean>
```

Java Configuration

```
@Bean
public XStreamMarshaller tradeMarshaller() {
    Map<String, Class> aliases = new HashMap<>();
    aliases.put("trade", Trade.class);
    aliases.put("price", BigDecimal.class);
    aliases.put("isin", String.class);
    aliases.put("customer", String.class);
    aliases.put("quantity", Long.class);

    XStreamMarshaller marshaller = new XStreamMarshaller();

    marshaller.setAliases(aliases);

    return marshaller;
}
```

On input, the reader reads the XML resource until it recognizes that a new fragment is about to start. By default, the reader matches the element name to recognize that a new fragment is about to start. The reader creates a standalone XML document from the fragment and passes the document to a deserializer (typically a wrapper around a Spring OXM `Unmarshaller`) to map the XML to a Java object.

In summary, this procedure is analogous to the following Java code, which uses the injection provided by the Spring configuration:

```

StaxEventItemReader<Trade> xmlStaxEventItemReader = new StaxEventItemReader<>();
Resource resource = new ByteArrayResource(xmlResource.getBytes());

Map aliases = new HashMap();
aliases.put("trade", "org.springframework.batch.sample.domain.trade.Trade");
aliases.put("price", "java.math.BigDecimal");
aliases.put("customer", "java.lang.String");
aliases.put("isin", "java.lang.String");
aliases.put("quantity", "java.lang.Long");
XStreamMarshaller unmarshaller = new XStreamMarshaller();
unmarshaller.setAliases(aliases);
xmlStaxEventItemReader.setUnmarshaller(unmarshaller);
xmlStaxEventItemReader.setResource(resource);
xmlStaxEventItemReader.setFragmentRootElementName("trade");
xmlStaxEventItemReader.open(new ExecutionContext());

boolean hasNext = true;

Trade trade = null;

while (hasNext) {
    trade = xmlStaxEventItemReader.read();
    if (trade == null) {
        hasNext = false;
    }
    else {
        System.out.println(trade);
    }
}
}

```

6.7.2. StaxEventItemWriter

Output works symmetrically to input. The `StaxEventItemWriter` needs a `Resource`, a marshaller, and a `rootTagName`. A Java object is passed to a marshaller (typically a standard Spring OXM Marshaller) which writes to a `Resource` by using a custom event writer that filters the `StartDocument` and `EndDocument` events produced for each fragment by the OXM tools. The following example uses the `StaxEventItemWriter`:

XML Configuration

```

<bean id="itemWriter" class="org.springframework.batch.item.xml.StaxEventItemWriter">
    <property name="resource" ref="outputResource" />
    <property name="marshaller" ref="tradeMarshaller" />
    <property name="rootTagName" value="trade" />
    <property name="overwriteOutput" value="true" />
</bean>

```

Java Configuration

```
@Bean
public StaxEventItemWriter itemWriter(Resource outputResource) {
    return new StaxEventItemWriterBuilder<Trade>()
        .name("tradesWriter")
        .marshaller(tradeMarshaller())
        .resource(outputResource)
        .rootTagName("trade")
        .overwriteOutput(true)
        .build();
}
```

The preceding configuration sets up the three required properties and sets the optional `overwriteOutput=true` attribute, mentioned earlier in this chapter for specifying whether an existing file can be overwritten. It should be noted the marshaller used for the writer in the following example is the exact same as the one used in the reading example from earlier in the chapter:

XML Configuration

```
<bean id="customerCreditMarshaller"
    class="org.springframework.xml.xstream.XStreamMarshaller">
    <property name="aliases">
        <util:map id="aliases">
            <entry key="customer"
                value="org.springframework.batch.sample.domain.trade.Trade" />
            <entry key="price" value="java.math.BigDecimal" />
            <entry key="isin" value="java.lang.String" />
            <entry key="customer" value="java.lang.String" />
            <entry key="quantity" value="java.lang.Long" />
        </util:map>
    </property>
</bean>
```

```
@Bean
public XStreamMarshaller customerCreditMarshaller() {
    XStreamMarshaller marshaller = new XStreamMarshaller();

    Map<String, Class> aliases = new HashMap<>();
    aliases.put("trade", Trade.class);
    aliases.put("price", BigDecimal.class);
    aliases.put("isin", String.class);
    aliases.put("customer", String.class);
    aliases.put("quantity", Long.class);

    marshaller.setAliases(aliases);

    return marshaller;
}
```

To summarize with a Java example, the following code illustrates all of the points discussed, demonstrating the programmatic setup of the required properties:

```

FileSystemResource resource = new FileSystemResource("data/outputFile.xml")

Map aliases = new HashMap();
aliases.put("trade", "org.springframework.batch.sample.domain.trade.Trade");
aliases.put("price", "java.math.BigDecimal");
aliases.put("customer", "java.lang.String");
aliases.put("isin", "java.lang.String");
aliases.put("quantity", "java.lang.Long");
Marshaller marshaller = new XStreamMarshaller();
marshaller.setAliases(aliases);

StaxEventItemWriter staxItemWriter =
    new StaxEventItemWriterBuilder<Trade>()
        .name("tradesWriter")
        .marshaller(marshaller)
        .resource(resource)
        .rootTagName("trade")
        .overwriteOutput(true)
        .build();

staxItemWriter.afterPropertiesSet();

ExecutionContext executionContext = new ExecutionContext();
staxItemWriter.open(executionContext);
Trade trade = new Trade();
trade.setPrice(11.39);
trade.setIsin("XYZ0001");
trade.setQuantity(5L);
trade.setCustomer("Customer1");
staxItemWriter.write(trade);

```

6.8. JSON Item Readers And Writers

Spring Batch provides support for reading and Writing JSON resources in the following format:

```
[
  {
    "isin": "123",
    "quantity": 1,
    "price": 1.2,
    "customer": "foo"
  },
  {
    "isin": "456",
    "quantity": 2,
    "price": 1.4,
    "customer": "bar"
  }
]
```

It is assumed that the JSON resource is an array of JSON objects corresponding to individual items. Spring Batch is not tied to any particular JSON library.

6.8.1. `JsonItemReader`

The `JsonItemReader` delegates JSON parsing and binding to implementations of the `org.springframework.batch.item.json.JsonObjectReader` interface. This interface is intended to be implemented by using a streaming API to read JSON objects in chunks. Two implementations are currently provided:

- `Jackson` through the `org.springframework.batch.item.json.JacksonJsonObjectReader`
- `Gson` through the `org.springframework.batch.item.json.GsonJsonObjectReader`

To be able to process JSON records, the following is needed:

- `Resource`: A Spring Resource that represents the JSON file to read.
- `JsonObjectReader`: A JSON object reader to parse and bind JSON objects to items

The following example shows how to define a `JsonItemReader` that works with the previous JSON resource `org.springframework.batch.item.json.trades.json` and a `JsonObjectReader` based on Jackson:

```
@Bean
public JsonItemReader<Trade> jsonItemReader() {
    return new JsonItemReaderBuilder<Trade>()
        .jsonObjectReader(new JacksonJsonObjectReader<>(Trade.class))
        .resource(new ClassPathResource("trades.json"))
        .name("tradeJsonItemReader")
        .build();
}
```

6.8.2. JsonFileItemWriter

The `JsonFileItemWriter` delegates the marshalling of items to the `org.springframework.batch.item.json.JsonObjectMarshaller` interface. The contract of this interface is to take an object and marshal it to a JSON `String`. Two implementations are currently provided:

- `Jackson` through the `org.springframework.batch.item.json.JacksonJsonObjectMarshaller`
- `Gson` through the `org.springframework.batch.item.json.GsonJsonObjectMarshaller`

To be able to write JSON records, the following is needed:

- `Resource`: A Spring `Resource` that represents the JSON file to write
- `JsonObjectMarshaller`: A JSON object marshaller to marshal objects to JSON format

The following example shows how to define a `JsonFileItemWriter`:

```
@Bean
public JsonFileItemWriter<Trade> jsonFileItemWriter() {
    return new JsonFileItemWriterBuilder<Trade>()
        .jsonObjectMarshaller(new JacksonJsonObjectMarshaller<>())
        .resource(new ClassPathResource("trades.json"))
        .name("tradeJsonFileItemWriter")
        .build();
}
```

6.9. Multi-File Input

It is a common requirement to process multiple files within a single `Step`. Assuming the files all have the same formatting, the `MultiResourceItemReader` supports this type of input for both XML and flat file processing. Consider the following files in a directory:

```
file-1.txt file-2.txt ignored.txt
```

`file-1.txt` and `file-2.txt` are formatted the same and, for business reasons, should be processed together. The `MultiResourceItemReader` can be used to read in both files by using wildcards, as shown in the following example:

XML Configuration

```
<bean id="multiResourceReader" class="org.spr...MultiResourceItemReader">
    <property name="resources" value="classpath:data/input/file-*.txt" />
    <property name="delegate" ref="flatFileItemReader" />
</bean>
```

```

@Bean
public MultiResourceItemReader multiResourceReader() {
    return new MultiResourceItemReaderBuilder<Foo>()
        .delegate(flatFileItemReader())
        .resources(resources())
        .build();
}

```

The referenced delegate is a simple `FlatFileItemReader`. The above configuration reads input from both files, handling rollback and restart scenarios. It should be noted that, as with any `ItemReader`, adding extra input (in this case a file) could cause potential issues when restarting. It is recommended that batch jobs work with their own individual directories until completed successfully.



Input resources are ordered by using `MultiResourceItemReader#setComparator(Comparator)` to make sure resource ordering is preserved between job runs in restart scenario.

6.10. Database

Like most enterprise application styles, a database is the central storage mechanism for batch. However, batch differs from other application styles due to the sheer size of the datasets with which the system must work. If a SQL statement returns 1 million rows, the result set probably holds all returned results in memory until all rows have been read. Spring Batch provides two types of solutions for this problem:

- [Cursor-based ItemReader Implementations](#)
- [Paging ItemReader Implementations](#)

6.10.1. Cursor-based ItemReader Implementations

Using a database cursor is generally the default approach of most batch developers, because it is the database's solution to the problem of 'streaming' relational data. The Java `ResultSet` class is essentially an object oriented mechanism for manipulating a cursor. A `ResultSet` maintains a cursor to the current row of data. Calling `next` on a `ResultSet` moves this cursor to the next row. The Spring Batch cursor-based `ItemReader` implementation opens a cursor on initialization and moves the cursor forward one row for every call to `read`, returning a mapped object that can be used for processing. The `close` method is then called to ensure all resources are freed up. The Spring core `JdbcTemplate` gets around this problem by using the callback pattern to completely map all rows in a `ResultSet` and close before returning control back to the method caller. However, in batch, this must wait until the step is complete. The following image shows a generic diagram of how a cursor-based `ItemReader` works. Note that, while the example uses SQL (because SQL is so widely known), any technology could implement the basic approach.

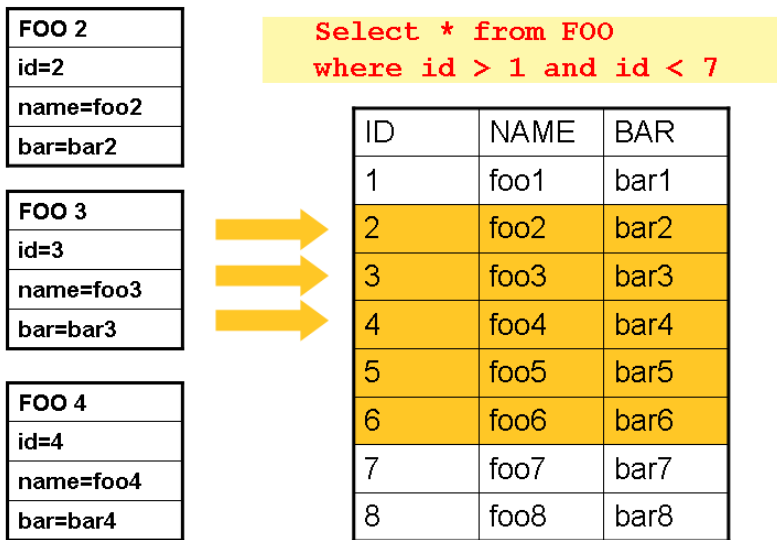

Figure 19. Cursor Example

This example illustrates the basic pattern. Given a 'FOO' table, which has three columns: **ID**, **NAME**, and **BAR**, select all rows with an ID greater than 1 but less than 7. This puts the beginning of the cursor (row 1) on ID 2. The result of this row should be a completely mapped **Foo** object. Calling **read()** again moves the cursor to the next row, which is the **Foo** with an ID of 3. The results of these reads are written out after each **read**, allowing the objects to be garbage collected (assuming no instance variables are maintaining references to them).

JdbcCursorItemReader

JdbcCursorItemReader is the JDBC implementation of the cursor-based technique. It works directly with a **ResultSet** and requires an SQL statement to run against a connection obtained from a **DataSource**. The following database schema is used as an example:

```
CREATE TABLE CUSTOMER (
  ID BIGINT IDENTITY PRIMARY KEY,
  NAME VARCHAR(45),
  CREDIT FLOAT
);
```

Many people prefer to use a domain object for each row, so the following example uses an implementation of the **RowMapper** interface to map a **CustomerCredit** object:

```

public class CustomerCreditRowMapper implements RowMapper<CustomerCredit> {

    public static final String ID_COLUMN = "id";
    public static final String NAME_COLUMN = "name";
    public static final String CREDIT_COLUMN = "credit";

    public CustomerCredit mapRow(ResultSet rs, int rowNum) throws SQLException {
        CustomerCredit customerCredit = new CustomerCredit();

        customerCredit.setId(rs.getInt(ID_COLUMN));
        customerCredit.setName(rs.getString(NAME_COLUMN));
        customerCredit.setCredit(rs.getBigDecimal(CREDIT_COLUMN));

        return customerCredit;
    }
}

```

Because `JdbcCursorItemReader` shares key interfaces with `JdbcTemplate`, it is useful to see an example of how to read in this data with `JdbcTemplate`, in order to contrast it with the `ItemReader`. For the purposes of this example, assume there are 1,000 rows in the `CUSTOMER` database. The first example uses `JdbcTemplate`:

```

//For simplicity sake, assume a dataSource has already been obtained
JdbcTemplate jdbcTemplate = new JdbcTemplate(dataSource);
List customerCredits = jdbcTemplate.query("SELECT ID, NAME, CREDIT from CUSTOMER",
                                         new CustomerCreditRowMapper());

```

After running the preceding code snippet, the `customerCredits` list contains 1,000 `CustomerCredit` objects. In the query method, a connection is obtained from the `DataSource`, the provided SQL is run against it, and the `mapRow` method is called for each row in the `ResultSet`. Contrast this with the approach of the `JdbcCursorItemReader`, shown in the following example:

```

JdbcCursorItemReader itemReader = new JdbcCursorItemReader();
itemReader.setDataSource(dataSource);
itemReader.setSql("SELECT ID, NAME, CREDIT from CUSTOMER");
itemReader.setRowMapper(new CustomerCreditRowMapper());
int counter = 0;
ExecutionContext executionContext = new ExecutionContext();
itemReader.open(executionContext);
Object customerCredit = new Object();
while(customerCredit != null){
    customerCredit = itemReader.read();
    counter++;
}
itemReader.close();

```

After running the preceding code snippet, the counter equals 1,000. If the code above had put the

returned `customerCredit` into a list, the result would have been exactly the same as with the `JdbcTemplate` example. However, the big advantage of the `ItemReader` is that it allows items to be 'streamed'. The `read` method can be called once, the item can be written out by an `ItemWriter`, and then the next item can be obtained with `read`. This allows item reading and writing to be done in 'chunks' and committed periodically, which is the essence of high performance batch processing. Furthermore, it is very easily configured for injection into a Spring Batch `Step`, as shown in the following example:

XML Configuration

```
<bean id="itemReader" class="org.spr...JdbcCursorItemReader">
  <property name="dataSource" ref="dataSource"/>
  <property name="sql" value="select ID, NAME, CREDIT from CUSTOMER"/>
  <property name="rowMapper">
    <bean class="org.springframework.batch.sample.domain.CustomerCreditRowMapper"
  "/>
  </property>
</bean>
```

Java Configuration

```
@Bean
public JdbcCursorItemReader<CustomerCredit> itemReader() {
    return new JdbcCursorItemReaderBuilder<CustomerCredit>()
        .dataSource(this.dataSource)
        .name("creditReader")
        .sql("select ID, NAME, CREDIT from CUSTOMER")
        .rowMapper(new CustomerCreditRowMapper())
        .build();
}
```

Additional Properties

Because there are so many varying options for opening a cursor in Java, there are many properties on the `JdbcCursorItemReader` that can be set, as described in the following table:

Table 16. `JdbcCursorItemReader` Properties

<code>ignoreWarnings</code>	Determines whether or not <code>SQLWarnings</code> are logged or cause an exception. The default is <code>true</code> (meaning that warnings are logged).
<code>fetchSize</code>	Gives the JDBC driver a hint as to the number of rows that should be fetched from the database when more rows are needed by the <code>ResultSet</code> object used by the <code>ItemReader</code> . By default, no hint is given.

maxRows	Sets the limit for the maximum number of rows the underlying <code>ResultSet</code> can hold at any one time.
queryTimeout	Sets the number of seconds the driver waits for a <code>Statement</code> object to run. If the limit is exceeded, a <code>DataAccessException</code> is thrown. (Consult your driver vendor documentation for details).
verifyCursorPosition	Because the same <code>ResultSet</code> held by the <code>ItemReader</code> is passed to the <code>RowMapper</code> , it is possible for users to call <code>ResultSet.next()</code> themselves, which could cause issues with the reader's internal count. Setting this value to <code>true</code> causes an exception to be thrown if the cursor position is not the same after the <code>RowMapper</code> call as it was before.
saveState	Indicates whether or not the reader's state should be saved in the <code>ExecutionContext</code> provided by <code>ItemStream#update(ExecutionContext)</code> . The default is <code>true</code> .
driverSupportsAbsolute	Indicates whether the JDBC driver supports setting the absolute row on a <code>ResultSet</code> . It is recommended that this is set to <code>true</code> for JDBC drivers that support <code>ResultSet.absolute()</code> , as it may improve performance, especially if a step fails while working with a large data set. Defaults to <code>false</code> .
setUseSharedExtendedConnection	Indicates whether the connection used for the cursor should be used by all other processing, thus sharing the same transaction. If this is set to <code>false</code> , then the cursor is opened with its own connection and does not participate in any transactions started for the rest of the step processing. If you set this flag to <code>true</code> then you must wrap the <code>DataSource</code> in an <code>ExtendedConnectionDataSourceProxy</code> to prevent the connection from being closed and released after each commit. When you set this option to <code>true</code> , the statement used to open the cursor is created with both 'READ_ONLY' and 'HOLD_CURSORS_OVER_COMMIT' options. This allows holding the cursor open over transaction start and commits performed in the step processing. To use this feature, you need a database that supports this and a JDBC driver supporting JDBC 3.0 or later. Defaults to <code>false</code> .

HibernateCursorItemReader

Just as normal Spring users make important decisions about whether or not to use ORM solutions,

which affect whether or not they use a `JdbcTemplate` or a `HibernateTemplate`, Spring Batch users have the same options. `HibernateCursorItemReader` is the Hibernate implementation of the cursor technique. Hibernate's usage in batch has been fairly controversial. This has largely been because Hibernate was originally developed to support online application styles. However, that does not mean it cannot be used for batch processing. The easiest approach for solving this problem is to use a `StatelessSession` rather than a standard session. This removes all of the caching and dirty checking Hibernate employs and that can cause issues in a batch scenario. For more information on the differences between stateless and normal hibernate sessions, refer to the documentation of your specific hibernate release. The `HibernateCursorItemReader` lets you declare an HQL statement and pass in a `SessionFactory`, which will pass back one item per call to read in the same basic fashion as the `JdbcCursorItemReader`. The following example configuration uses the same 'customer credit' example as the JDBC reader:

```
HibernateCursorItemReader itemReader = new HibernateCursorItemReader();
itemReader.setQueryString("from CustomerCredit");
//For simplicity sake, assume sessionFactory already obtained.
itemReader.setSessionFactory(sessionFactory);
itemReader.setUseStatelessSession(true);
int counter = 0;
ExecutionContext executionContext = new ExecutionContext();
itemReader.open(executionContext);
Object customerCredit = new Object();
while(customerCredit != null){
    customerCredit = itemReader.read();
    counter++;
}
itemReader.close();
```

This configured `ItemReader` returns `CustomerCredit` objects in the exact same manner as described by the `JdbcCursorItemReader`, assuming hibernate mapping files have been created correctly for the `Customer` table. The 'useStatelessSession' property defaults to true but has been added here to draw attention to the ability to switch it on or off. It is also worth noting that the fetch size of the underlying cursor can be set via the `setFetchSize` property. As with `JdbcCursorItemReader`, configuration is straightforward, as shown in the following example:

XML Configuration

```
<bean id="itemReader"
      class="org.springframework.batch.item.database.HibernateCursorItemReader">
    <property name="sessionFactory" ref="sessionFactory" />
    <property name="queryString" value="from CustomerCredit" />
</bean>
```

Java Configuration

```
@Bean
public HibernateCursorItemReader itemReader(SessionFactory sessionFactory) {
    return new HibernateCursorItemReaderBuilder<CustomerCredit>()
        .name("creditReader")
        .sessionFactory(sessionFactory)
        .queryString("from CustomerCredit")
        .build();
}
```

StoredProcedureItemReader

Sometimes it is necessary to obtain the cursor data by using a stored procedure. The `StoredProcedureItemReader` works like the `JdbcCursorItemReader`, except that, instead of running a query to obtain a cursor, it runs a stored procedure that returns a cursor. The stored procedure can return the cursor in three different ways:

- As a returned `ResultSet` (used by SQL Server, Sybase, DB2, Derby, and MySQL).
- As a ref-cursor returned as an out parameter (used by Oracle and PostgreSQL).
- As the return value of a stored function call.

The following example configuration uses the same 'customer credit' example as earlier examples:

XML Configuration

```
<bean id="reader" class="o.s.batch.item.database.StoredProcedureItemReader">
    <property name="dataSource" ref="dataSource"/>
    <property name="procedureName" value="sp_customer_credit"/>
    <property name="rowMapper">
        <bean class="org.springframework.batch.sample.domain.CustomerCreditRowMapper"
            "/>
    </property>
</bean>
```

Java Configuration

```
@Bean
public StoredProcedureItemReader reader(DataSource dataSource) {
    StoredProcedureItemReader reader = new StoredProcedureItemReader();

    reader.setDataSource(dataSource);
    reader.setProcedureName("sp_customer_credit");
    reader.setRowMapper(new CustomerCreditRowMapper());

    return reader;
}
```

The preceding example relies on the stored procedure to provide a `ResultSet` as a returned result

(option 1 from earlier).

If the stored procedure returned a `ref-cursor` (option 2), then we would need to provide the position of the out parameter that is the returned `ref-cursor`. The following example shows how to work with the first parameter being a `ref-cursor`:

XML Configuration

```
<bean id="reader" class="o.s.batch.item.database.StoredProcedureItemReader">
  <property name="dataSource" ref="dataSource"/>
  <property name="procedureName" value="sp_customer_credit"/>
  <property name="refCursorPosition" value="1"/>
  <property name="rowMapper">
    <bean class="org.springframework.batch.sample.domain.CustomerCreditRowMapper"
  "/>
  </property>
</bean>
```

Java Configuration

```
@Bean
public StoredProcedureItemReader reader(DataSource dataSource) {
    StoredProcedureItemReader reader = new StoredProcedureItemReader();

    reader.setDataSource(dataSource);
    reader.setProcedureName("sp_customer_credit");
    reader.setRowMapper(new CustomerCreditRowMapper());
    reader.setRefCursorPosition(1);

    return reader;
}
```

If the cursor was returned from a stored function (option 3), we would need to set the property `function` to `true`. It defaults to `false`. The following example shows what that would look like:

XML Configuration

```
<bean id="reader" class="o.s.batch.item.database.StoredProcedureItemReader">
  <property name="dataSource" ref="dataSource"/>
  <property name="procedureName" value="sp_customer_credit"/>
  <property name="function" value="true"/>
  <property name="rowMapper">
    <bean class="org.springframework.batch.sample.domain.CustomerCreditRowMapper"
  "/>
  </property>
</bean>
```

```
@Bean
public StoredProcedureItemReader reader(DataSource dataSource) {
    StoredProcedureItemReader reader = new StoredProcedureItemReader();

    reader.setDataSource(dataSource);
    reader.setProcedureName("sp_customer_credit");
    reader.setRowMapper(new CustomerCreditRowMapper());
    reader.setFunction(true);

    return reader;
}
```

In all of these cases, we need to define a `RowMapper` as well as a `DataSource` and the actual procedure name.

If the stored procedure or function takes in parameters, then they must be declared and set via the `parameters` property. The following example, for Oracle, declares three parameters. The first one is the out parameter that returns the ref-cursor, and the second and third are in parameters that takes a value of type `INTEGER`.

```
<bean id="reader" class="o.s.batch.item.database.StoredProcedureItemReader">
  <property name="dataSource" ref="dataSource"/>
  <property name="procedureName" value="spring.cursor_func"/>
  <property name="parameters">
    <list>
      <bean class="org.springframework.jdbc.core.SqlOutParameter">
        <constructor-arg index="0" value="newid"/>
        <constructor-arg index="1">
          <util:constant static-field="oracle.jdbc.OracleTypes.CURSOR"/>
        </constructor-arg>
      </bean>
      <bean class="org.springframework.jdbc.core.SqlParameter">
        <constructor-arg index="0" value="amount"/>
        <constructor-arg index="1">
          <util:constant static-field="java.sql.Types.INTEGER"/>
        </constructor-arg>
      </bean>
      <bean class="org.springframework.jdbc.core.SqlParameter">
        <constructor-arg index="0" value="custid"/>
        <constructor-arg index="1">
          <util:constant static-field="java.sql.Types.INTEGER"/>
        </constructor-arg>
      </bean>
    </list>
  </property>
  <property name="refCursorPosition" value="1"/>
  <property name="rowMapper" ref="rowMapper"/>
  <property name="preparedStatementSetter" ref="parameterSetter"/>
</bean>
```



```

@Bean
public StoredProcedureItemReader reader(DataSource dataSource) {
    List<SqlParameter> parameters = new ArrayList<>();
    parameters.add(new SqlOutParameter("newId", OracleTypes.CURSOR));
    parameters.add(new SqlParameter("amount", Types.INTEGER);
    parameters.add(new SqlParameter("custId", Types.INTEGER);

    StoredProcedureItemReader reader = new StoredProcedureItemReader();

    reader.setDataSource(dataSource);
    reader.setProcedureName("spring.cursor_func");
    reader.setParameters(parameters);
    reader.setRefCursorPosition(1);
    reader.setRowMapper(rowMapper());
    reader.setPreparedStatementSetter(parameterSetter());

    return reader;
}

```

In addition to the parameter declarations, we need to specify a `PreparedStatementSetter` implementation that sets the parameter values for the call. This works the same as for the `JdbcCursorItemReader` above. All the additional properties listed in [Additional Properties](#) apply to the `StoredProcedureItemReader` as well.

6.10.2. Paging `ItemReader` Implementations

An alternative to using a database cursor is running multiple queries where each query fetches a portion of the results. We refer to this portion as a page. Each query must specify the starting row number and the number of rows that we want returned in the page.

`JdbcPagingItemReader`

One implementation of a paging `ItemReader` is the `JdbcPagingItemReader`. The `JdbcPagingItemReader` needs a `PagingQueryProvider` responsible for providing the SQL queries used to retrieve the rows making up a page. Since each database has its own strategy for providing paging support, we need to use a different `PagingQueryProvider` for each supported database type. There is also the `SqlPagingQueryProviderFactoryBean` that auto-detects the database that is being used and determine the appropriate `PagingQueryProvider` implementation. This simplifies the configuration and is the recommended best practice.

The `SqlPagingQueryProviderFactoryBean` requires that you specify a `select` clause and a `from` clause. You can also provide an optional `where` clause. These clauses and the required `sortKey` are used to build an SQL statement.



It is important to have a unique key constraint on the `sortKey` to guarantee that no data is lost between executions.

After the reader has been opened, it passes back one item per call to `read` in the same basic fashion as any other `ItemReader`. The paging happens behind the scenes when additional rows are needed.

The following example configuration uses a similar 'customer credit' example as the cursor-based `ItemReaders` shown previously:

XML Configuration

```
<bean id="itemReader" class="org.spr...JdbcPagingItemReader">
  <property name="dataSource" ref="dataSource"/>
  <property name="queryProvider">
    <bean class="org.spr...SqlPagingQueryProviderFactoryBean">
      <property name="selectClause" value="select id, name, credit"/>
      <property name="fromClause" value="from customer"/>
      <property name="whereClause" value="where status=:status"/>
      <property name="sortKey" value="id"/>
    </bean>
  </property>
  <property name="parameterValues">
    <map>
      <entry key="status" value="NEW"/>
    </map>
  </property>
  <property name="pageSize" value="1000"/>
  <property name="rowMapper" ref="customerMapper"/>
</bean>
```

```

@Bean
public JdbcPagingItemReader itemReader(DataSource dataSource, PagingQueryProvider
queryProvider) {
    Map<String, Object> parameterValues = new HashMap<>();
    parameterValues.put("status", "NEW");

    return new JdbcPagingItemReaderBuilder<CustomerCredit>()
        .name("creditReader")
        .dataSource(dataSource)
        .queryProvider(queryProvider)
        .parameterValues(parameterValues)
        .rowMapper(customerCreditMapper())
        .pageSize(1000)
        .build();
}

@Bean
public SqlPagingQueryProviderFactoryBean queryProvider() {
    SqlPagingQueryProviderFactoryBean provider = new
SqlPagingQueryProviderFactoryBean();

    provider.setSelectClause("select id, name, credit");
    provider.setFromClause("from customer");
    provider.setWhereClause("where status=:status");
    provider.setSortKey("id");

    return provider;
}

```

This configured `ItemReader` returns `CustomerCredit` objects using the `RowMapper`, which must be specified. The 'pageSize' property determines the number of entities read from the database for each query run.

The 'parameterValues' property can be used to specify a `Map` of parameter values for the query. If you use named parameters in the `where` clause, the key for each entry should match the name of the named parameter. If you use a traditional '?' placeholder, then the key for each entry should be the number of the placeholder, starting with 1.

JpaPagingItemReader

Another implementation of a paging `ItemReader` is the `JpaPagingItemReader`. JPA does not have a concept similar to the Hibernate `StatelessSession`, so we have to use other features provided by the JPA specification. Since JPA supports paging, this is a natural choice when it comes to using JPA for batch processing. After each page is read, the entities become detached and the persistence context is cleared, to allow the entities to be garbage collected once the page is processed.

The `JpaPagingItemReader` lets you declare a JPQL statement and pass in a `EntityManagerFactory`. It then passes back one item per call to read in the same basic fashion as any other `ItemReader`. The

paging happens behind the scenes when additional entities are needed. The following example configuration uses the same 'customer credit' example as the JDBC reader shown previously:

XML Configuration

```
<bean id="itemReader" class="org.spr...JpaPagingItemReader">
  <property name="entityManagerFactory" ref="entityManagerFactory"/>
  <property name="queryString" value="select c from CustomerCredit c"/>
  <property name="pageSize" value="1000"/>
</bean>
```

Java Configuration

```
@Bean
public JpaPagingItemReader itemReader() {
    return new JpaPagingItemReaderBuilder<CustomerCredit>()
        .name("creditReader")
        .entityManagerFactory(entityManagerFactory())
        .queryString("select c from CustomerCredit c")
        .pageSize(1000)
        .build();
}
```

This configured `ItemReader` returns `CustomerCredit` objects in the exact same manner as described for the `JdbcPagingItemReader` above, assuming the `CustomerCredit` object has the correct JPA annotations or ORM mapping file. The 'pageSize' property determines the number of entities read from the database for each query execution.

6.10.3. Database ItemWriters

While both flat files and XML files have a specific `ItemWriter` instance, there is no exact equivalent in the database world. This is because transactions provide all the needed functionality. `ItemWriter` implementations are necessary for files because they must act as if they're transactional, keeping track of written items and flushing or clearing at the appropriate times. Databases have no need for this functionality, since the write is already contained in a transaction. Users can create their own DAOs that implement the `ItemWriter` interface or use one from a custom `ItemWriter` that's written for generic processing concerns. Either way, they should work without any issues. One thing to look out for is the performance and error handling capabilities that are provided by batching the outputs. This is most common when using hibernate as an `ItemWriter` but could have the same issues when using JDBC batch mode. Batching database output does not have any inherent flaws, assuming we are careful to flush and there are no errors in the data. However, any errors while writing can cause confusion, because there is no way to know which individual item caused an exception or even if any individual item was responsible, as illustrated in the following image:

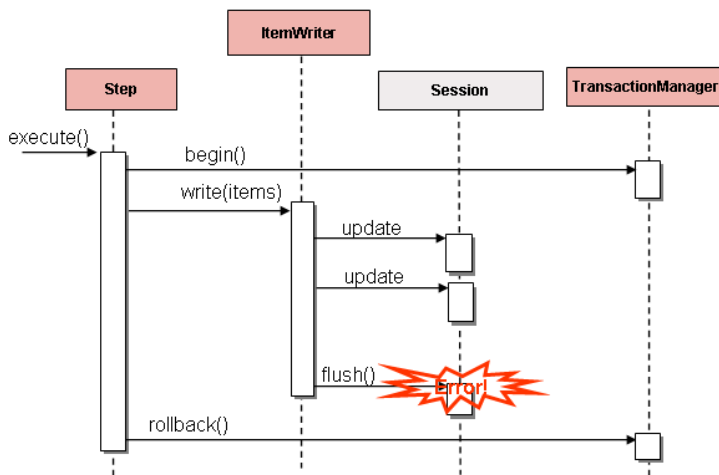

Figure 20. Error On Flush

If items are buffered before being written, any errors are not thrown until the buffer is flushed just before a commit. For example, assume that 20 items are written per chunk, and the 15th item throws a `DataIntegrityViolationException`. As far as the `Step` is concerned, all 20 items are written successfully, since there is no way to know that an error occurs until they are actually written. Once `Session#flush()` is called, the buffer is emptied and the exception is hit. At this point, there is nothing the `Step` can do. The transaction must be rolled back. Normally, this exception might cause the item to be skipped (depending upon the skip/retry policies), and then it is not written again. However, in the batched scenario, there is no way to know which item caused the issue. The whole buffer was being written when the failure happened. The only way to solve this issue is to flush after each item, as shown in the following image:

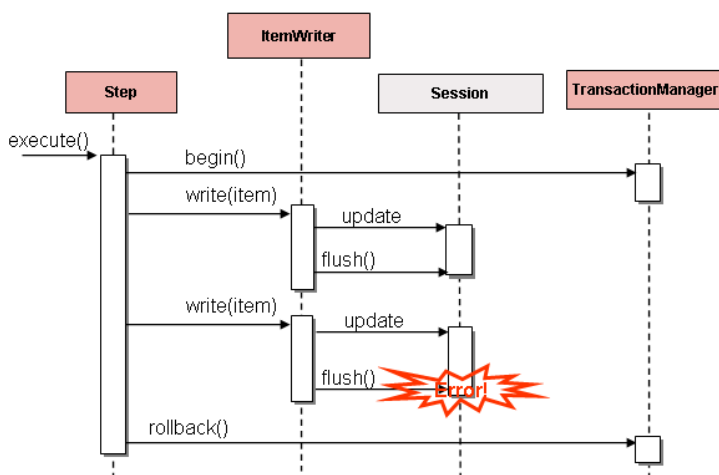

Figure 21. Error On Write

This is a common use case, especially when using Hibernate, and the simple guideline for implementations of `ItemWriter` is to flush on each call to `write()`. Doing so allows for items to be skipped reliably, with Spring Batch internally taking care of the granularity of the calls to `ItemWriter` after an error.

6.11. Reusing Existing Services

Batch systems are often used in conjunction with other application styles. The most common is an online system, but it may also support integration or even a thick client application by moving necessary bulk data that each application style uses. For this reason, it is common that many users want to reuse existing DAOs or other services within their batch jobs. The Spring container itself makes this fairly easy by allowing any necessary class to be injected. However, there may be cases where the existing service needs to act as an `ItemReader` or `ItemWriter`, either to satisfy the dependency of another Spring Batch class or because it truly is the main `ItemReader` for a step. It is fairly trivial to write an adapter class for each service that needs wrapping, but because it is such a common concern, Spring Batch provides implementations: `ItemReaderAdapter` and `ItemWriterAdapter`. Both classes implement the standard Spring method by invoking the delegate pattern and are fairly simple to set up. The following example uses the `ItemReaderAdapter`:

XML Configuration

```
<bean id="itemReader" class="org.springframework.batch.item.adapter.ItemReaderAdapter"
">
  <property name="targetObject" ref="fooService" />
  <property name="targetMethod" value="generateFoo" />
</bean>

<bean id="fooService" class="org.springframework.batch.item.sample.FooService" />
```

Java Configuration

```
@Bean
public ItemReaderAdapter itemReader() {
    ItemReaderAdapter reader = new ItemReaderAdapter();

    reader.setTargetObject(fooService());
    reader.setTargetMethod("generateFoo");

    return reader;
}

@Bean
public FooService fooService() {
    return new FooService();
}
```

One important point to note is that the contract of the `targetMethod` must be the same as the contract for `read`: When exhausted, it returns `null`. Otherwise, it returns an `Object`. Anything else prevents the framework from knowing when processing should end, either causing an infinite loop or incorrect failure, depending upon the implementation of the `ItemWriter`. The following example uses the `ItemWriterAdapter`:

XML Configuration

```
<bean id="itemWriter" class="org.springframework.batch.item.adapter.ItemWriterAdapter"
">
    <property name="targetObject" ref="fooService" />
    <property name="targetMethod" value="processFoo" />
</bean>

<bean id="fooService" class="org.springframework.batch.item.sample.FooService" />
```

Java Configuration

```
@Bean
public ItemWriterAdapter itemWriter() {
    ItemWriterAdapter writer = new ItemWriterAdapter();

    writer.setTargetObject(fooService());
    writer.setTargetMethod("processFoo");

    return writer;
}

@Bean
public FooService fooService() {
    return new FooService();
}
```

6.12. Validating Input

During the course of this chapter, multiple approaches to parsing input have been discussed. Each major implementation throws an exception if it is not 'well-formed'. The `FixedLengthTokenizer` throws an exception if a range of data is missing. Similarly, attempting to access an index in a `RowMapper` or `FieldSetMapper` that does not exist or is in a different format than the one expected causes an exception to be thrown. All of these types of exceptions are thrown before `read` returns. However, they do not address the issue of whether or not the returned item is valid. For example, if one of the fields is an age, it obviously cannot be negative. It may parse correctly, because it exists and is a number, but it does not cause an exception. Since there are already a plethora of validation frameworks, Spring Batch does not attempt to provide yet another. Rather, it provides a simple interface, called `Validator`, that can be implemented by any number of frameworks, as shown in the following interface definition:

```
public interface Validator<T> {

    void validate(T value) throws ValidationException;

}
```

The contract is that the `validate` method throws an exception if the object is invalid and returns normally if it is valid. Spring Batch provides an out of the box `ValidatingItemProcessor`, as shown in the following bean definition:

XML Configuration

```
<bean class="org.springframework.batch.item.validator.ValidatingItemProcessor">
  <property name="validator" ref="validator" />
</bean>

<bean id="validator" class="org.springframework.batch.item.validator.SpringValidator">
  <property name="validator">
    <bean class=
"org.springframework.batch.sample.domain.trade.internal.validator.TradeValidator"/>
  </property>
</bean>
```

Java Configuration

```
@Bean
public ValidatingItemProcessor itemProcessor() {
    ValidatingItemProcessor processor = new ValidatingItemProcessor();

    processor.setValidator(validator());

    return processor;
}

@Bean
public SpringValidator validator() {
    SpringValidator validator = new SpringValidator();

    validator.setValidator(new TradeValidator());

    return validator;
}
```

You can also use the `BeanValidatingItemProcessor` to validate items annotated with the Bean Validation API (JSR-303) annotations. For example, given the following type `Person`:

```

class Person {

    @NotEmpty
    private String name;

    public Person(String name) {
        this.name = name;
    }

    public String getName() {
        return name;
    }

    public void setName(String name) {
        this.name = name;
    }

}

```

you can validate items by declaring a `BeanValidatingItemProcessor` bean in your application context and register it as a processor in your chunk-oriented step:

```

@Bean
public BeanValidatingItemProcessor<Person> beanValidatingItemProcessor() throws
Exception {
    BeanValidatingItemProcessor<Person> beanValidatingItemProcessor = new
BeanValidatingItemProcessor<>();
    beanValidatingItemProcessor.setFilter(true);

    return beanValidatingItemProcessor;
}

```

6.13. Preventing State Persistence

By default, all of the `ItemReader` and `ItemWriter` implementations store their current state in the `ExecutionContext` before it is committed. However, this may not always be the desired behavior. For example, many developers choose to make their database readers 'rerunnable' by using a process indicator. An extra column is added to the input data to indicate whether or not it has been processed. When a particular record is being read (or written) the processed flag is flipped from `false` to `true`. The SQL statement can then contain an extra statement in the `where` clause, such as `where PROCESSED_IND = false`, thereby ensuring that only unprocessed records are returned in the case of a restart. In this scenario, it is preferable to not store any state, such as the current row number, since it is irrelevant upon restart. For this reason, all readers and writers include the 'saveState' property, as shown in the following example:

```

<bean id="playerSummarizationSource" class="org.spr...JdbcCursorItemReader">
  <property name="dataSource" ref="dataSource" />
  <property name="rowMapper">
    <bean class="org.springframework.batch.sample.PlayerSummaryMapper" />
  </property>
  <property name="saveState" value="false" />
  <property name="sql">
    <value>
      SELECT games.player_id, games.year_no, SUM(COMPLETES),
      SUM(ATTEMPTS), SUM(PASSING_YARDS), SUM(PASSING_TD),
      SUM(INTERCEPTIONS), SUM(RUSHES), SUM(RUSH_YARDS),
      SUM(RECEPTIONS), SUM(RECEPTIONS_YARDS), SUM(TOTAL_TD)
      from games, players where players.player_id =
      games.player_id group by games.player_id, games.year_no
    </value>
  </property>
</bean>

```

```

@Bean
public JdbcCursorItemReader playerSummarizationSource(DataSource dataSource) {
    return new JdbcCursorItemReaderBuilder<PlayerSummary>()
        .dataSource(dataSource)
        .rowMapper(new PlayerSummaryMapper())
        .saveState(false)
        .sql("SELECT games.player_id, games.year_no, SUM(COMPLETES),"
            + "SUM(ATTEMPTS), SUM(PASSING_YARDS), SUM(PASSING_TD),"
            + "SUM(INTERCEPTIONS), SUM(RUSHES), SUM(RUSH_YARDS),"
            + "SUM(RECEPTIONS), SUM(RECEPTIONS_YARDS), SUM(TOTAL_TD)"
            + "from games, players where players.player_id ="
            + "games.player_id group by games.player_id, games.year_no")
        .build();
}

```

The `ItemReader` configured above does not make any entries in the `ExecutionContext` for any executions in which it participates.

6.14. Creating Custom ItemReaders and ItemWriters

So far, this chapter has discussed the basic contracts of reading and writing in Spring Batch and some common implementations for doing so. However, these are all fairly generic, and there are many potential scenarios that may not be covered by out-of-the-box implementations. This section shows, by using a simple example, how to create a custom `ItemReader` and `ItemWriter` implementation and implement their contracts correctly. The `ItemReader` also implements `ItemStream`, in order to illustrate how to make a reader or writer restartable.

6.14.1. Custom `ItemReader` Example

For the purpose of this example, we create a simple `ItemReader` implementation that reads from a provided list. We start by implementing the most basic contract of `ItemReader`, the `read` method, as shown in the following code:

```
public class CustomItemReader<T> implements ItemReader<T>{

    List<T> items;

    public CustomItemReader(List<T> items) {
        this.items = items;
    }

    public T read() throws Exception, UnexpectedInputException,
        NonTransientResourceException, ParseException {

        if (!items.isEmpty()) {
            return items.remove(0);
        }
        return null;
    }
}
```

The preceding class takes a list of items and returns them one at a time, removing each from the list. When the list is empty, it returns `null`, thus satisfying the most basic requirements of an `ItemReader`, as illustrated in the following test code:

```
List<String> items = new ArrayList<>();
items.add("1");
items.add("2");
items.add("3");

ItemReader itemReader = new CustomItemReader<>(items);
assertEquals("1", itemReader.read());
assertEquals("2", itemReader.read());
assertEquals("3", itemReader.read());
assertNull(itemReader.read());
```

Making the `ItemReader` Restartable

The final challenge is to make the `ItemReader` restartable. Currently, if processing is interrupted and begins again, the `ItemReader` must start at the beginning. This is actually valid in many scenarios, but it is sometimes preferable that a batch job restarts where it left off. The key discriminant is often whether the reader is stateful or stateless. A stateless reader does not need to worry about restartability, but a stateful one has to try to reconstitute its last known state on restart. For this reason, we recommend that you keep custom readers stateless if possible, so you need not worry about restartability.

If you do need to store state, then the `ItemStream` interface should be used:

```
public class CustomItemReader<T> implements ItemReader<T>, ItemStream {

    List<T> items;
    int currentIndex = 0;
    private static final String CURRENT_INDEX = "current.index";

    public CustomItemReader(List<T> items) {
        this.items = items;
    }

    public T read() throws Exception, UnexpectedInputException,
        ParseException, NonTransientResourceException {

        if (currentIndex < items.size()) {
            return items.get(currentIndex++);
        }

        return null;
    }

    public void open(ExecutionContext executionContext) throws ItemStreamException {
        if(executionContext.containsKey(CURRENT_INDEX)){
            currentIndex = new Long(executionContext.getLong(CURRENT_INDEX)).intValue
();
        }
        else{
            currentIndex = 0;
        }
    }

    public void update(ExecutionContext executionContext) throws ItemStreamException {
        executionContext.putLong(CURRENT_INDEX, new Long(currentIndex).longValue());
    }

    public void close() throws ItemStreamException {}
}
```

On each call to the `ItemStream update` method, the current index of the `ItemReader` is stored in the provided `ExecutionContext` with a key of 'current.index'. When the `ItemStream open` method is called, the `ExecutionContext` is checked to see if it contains an entry with that key. If the key is found, then the current index is moved to that location. This is a fairly trivial example, but it still meets the general contract:

```

ExecutionContext executionContext = new ExecutionContext();
((ItemStream)itemReader).open(executionContext);
assertEquals("1", itemReader.read());
((ItemStream)itemReader).update(executionContext);

List<String> items = new ArrayList<>();
items.add("1");
items.add("2");
items.add("3");
itemReader = new CustomItemReader<>(items);

((ItemStream)itemReader).open(executionContext);
assertEquals("2", itemReader.read());

```

Most `ItemReaders` have much more sophisticated restart logic. The `JdbcCursorItemReader`, for example, stores the row ID of the last processed row in the cursor.

It is also worth noting that the key used within the `ExecutionContext` should not be trivial. That is because the same `ExecutionContext` is used for all `ItemStreams` within a `Step`. In most cases, simply prepending the key with the class name should be enough to guarantee uniqueness. However, in the rare cases where two of the same type of `ItemStream` are used in the same step (which can happen if two files are needed for output), a more unique name is needed. For this reason, many of the Spring Batch `ItemReader` and `ItemWriter` implementations have a `setName()` property that lets this key name be overridden.

6.14.2. Custom `ItemWriter` Example

Implementing a Custom `ItemWriter` is similar in many ways to the `ItemReader` example above but differs in enough ways as to warrant its own example. However, adding restartability is essentially the same, so it is not covered in this example. As with the `ItemReader` example, a `List` is used in order to keep the example as simple as possible:

```

public class CustomItemWriter<T> implements ItemWriter<T> {

    List<T> output = TransactionAwareProxyFactory.createTransactionallList();

    public void write(List<? extends T> items) throws Exception {
        output.addAll(items);
    }

    public List<T> getOutput() {
        return output;
    }
}

```

Making the `ItemWriter` Restartable

To make the `ItemWriter` restartable, we would follow the same process as for the `ItemReader`, adding and implementing the `ItemStream` interface to synchronize the execution context. In the example, we might have to count the number of items processed and add that as a footer record. If we needed to do that, we could implement `ItemStream` in our `ItemWriter` so that the counter was reconstituted from the execution context if the stream was re-opened.

In many realistic cases, custom `ItemWriters` also delegate to another writer that itself is restartable (for example, when writing to a file), or else it writes to a transactional resource and so does not need to be restartable, because it is stateless. When you have a stateful writer you should probably be sure to implement `ItemStream` as well as `ItemWriter`. Remember also that the client of the writer needs to be aware of the `ItemStream`, so you may need to register it as a stream in the configuration.

6.15. Item Reader and Writer Implementations

In this section, we will introduce you to readers and writers that have not already been discussed in the previous sections.

6.15.1. Decorators

In some cases, a user needs specialized behavior to be appended to a pre-existing `ItemReader`. Spring Batch offers some out of the box decorators that can add additional behavior to to your `ItemReader` and `ItemWriter` implementations.

Spring Batch includes the following decorators:

- `SynchronizedItemStreamReader`
- `SingleItemPeekableItemReader`
- `MultiResourceItemWriter`
- `ClassifierCompositeItemWriter`
- `ClassifierCompositeItemProcessor`

`SynchronizedItemStreamReader`

When using an `ItemReader` that is not thread safe, Spring Batch offers the `SynchronizedItemStreamReader` decorator, which can be used to make the `ItemReader` thread safe. Spring Batch provides a `SynchronizedItemStreamReaderBuilder` to construct an instance of the `SynchronizedItemStreamReader`.

`SingleItemPeekableItemReader`

Spring Batch includes a decorator that adds a peek method to an `ItemReader`. This peek method lets the user peek one item ahead. Repeated calls to the peek returns the same item, and this is the next item returned from the `read` method. Spring Batch provides a `SingleItemPeekableItemReaderBuilder` to construct an instance of the `SingleItemPeekableItemReader`.



`SingleItemPeekableItemReader`'s `peek` method is not thread-safe, because it would not be possible to honor the peek in multiple threads. Only one of the threads that peeked would get that item in the next call to read.

`MultiResourceItemWriter`

The `MultiResourceItemWriter` wraps a `ResourceAwareItemWriterItemStream` and creates a new output resource when the count of items written in the current resource exceeds the `itemCountLimitPerResource`. Spring Batch provides a `MultiResourceItemWriterBuilder` to construct an instance of the `MultiResourceItemWriter`.

`ClassifierCompositeItemWriter`

The `ClassifierCompositeItemWriter` calls one of a collection of `ItemWriter` implementations for each item, based on a router pattern implemented through the provided `Classifier`. The implementation is thread-safe if all delegates are thread-safe. Spring Batch provides a `ClassifierCompositeItemWriterBuilder` to construct an instance of the `ClassifierCompositeItemWriter`.

`ClassifierCompositeItemProcessor`

The `ClassifierCompositeItemProcessor` is an `ItemProcessor` that calls one of a collection of `ItemProcessor` implementations, based on a router pattern implemented through the provided `Classifier`. Spring Batch provides a `ClassifierCompositeItemProcessorBuilder` to construct an instance of the `ClassifierCompositeItemProcessor`.

6.15.2. Messaging Readers And Writers

Spring Batch offers the following readers and writers for commonly used messaging systems:

- `AmqpItemReader`
- `AmqpItemWriter`
- `JmsItemReader`
- `JmsItemWriter`
- `KafkaItemReader`
- `KafkaItemWriter`

`AmqpItemReader`

The `AmqpItemReader` is an `ItemReader` that uses an `AmqpTemplate` to receive or convert messages from an exchange. Spring Batch provides a `AmqpItemReaderBuilder` to construct an instance of the `AmqpItemReader`.

`AmqpItemWriter`

The `AmqpItemWriter` is an `ItemWriter` that uses an `AmqpTemplate` to send messages to an AMQP exchange. Messages are sent to the nameless exchange if the name not specified in the provided `AmqpTemplate`. Spring Batch provides an `AmqpItemWriterBuilder` to construct an instance of the `AmqpItemWriter`.

JmsItemReader

The `JmsItemReader` is an `ItemReader` for JMS that uses a `JmsTemplate`. The template should have a default destination, which is used to provide items for the `read()` method. Spring Batch provides a `JmsItemReaderBuilder` to construct an instance of the `JmsItemReader`.

JmsItemWriter

The `JmsItemWriter` is an `ItemWriter` for JMS that uses a `JmsTemplate`. The template should have a default destination, which is used to send items in `write(List)`. Spring Batch provides a `JmsItemWriterBuilder` to construct an instance of the `JmsItemWriter`.

KafkaItemReader

The `KafkaItemReader` is an `ItemReader` for an Apache Kafka topic. It can be configured to read messages from multiple partitions of the same topic. It stores message offsets in the execution context to support restart capabilities. Spring Batch provides a `KafkaItemReaderBuilder` to construct an instance of the `KafkaItemReader`.

KafkaItemWriter

The `KafkaItemWriter` is an `ItemWriter` for Apache Kafka that uses a `KafkaTemplate` to send events to a default topic. Spring Batch provides a `KafkaItemWriterBuilder` to construct an instance of the `KafkaItemWriter`.

6.15.3. Database Readers

Spring Batch offers the following database readers:

- `Neo4jItemReader`
- `MongoItemReader`
- `HibernateCursorItemReader`
- `HibernatePagingItemReader`
- `RepositoryItemReader`

Neo4jItemReader

The `Neo4jItemReader` is an `ItemReader` that reads objects from the graph database Neo4j by using a paging technique. Spring Batch provides a `Neo4jItemReaderBuilder` to construct an instance of the `Neo4jItemReader`.

MongoItemReader

The `MongoItemReader` is an `ItemReader` that reads documents from MongoDB by using a paging technique. Spring Batch provides a `MongoItemReaderBuilder` to construct an instance of the `MongoItemReader`.

HibernateCursorItemReader

The `HibernateCursorItemReader` is an `ItemStreamReader` for reading database records built on top of Hibernate. It executes the HQL query and then, when initialized, iterates over the result set as the `read()` method is called, successively returning an object corresponding to the current row. Spring

Batch provides a `HibernateCursorItemReaderBuilder` to construct an instance of the `HibernateCursorItemReader`.

HibernatePagingItemReader

The `HibernatePagingItemReader` is an `ItemReader` for reading database records built on top of Hibernate and reading only up to a fixed number of items at a time. Spring Batch provides a `HibernatePagingItemReaderBuilder` to construct an instance of the `HibernatePagingItemReader`.

RepositoryItemReader

The `RepositoryItemReader` is an `ItemReader` that reads records by using a `PagingAndSortingRepository`. Spring Batch provides a `RepositoryItemReaderBuilder` to construct an instance of the `RepositoryItemReader`.

6.15.4. Database Writers

Spring Batch offers the following database writers:

- `Neo4jItemWriter`
- `MongoItemWriter`
- `RepositoryItemWriter`
- `HibernateItemWriter`
- `JdbcBatchItemWriter`
- `JpaItemWriter`
- `GemfireItemWriter`

Neo4jItemWriter

The `Neo4jItemWriter` is an `ItemWriter` implementation that writes to a Neo4j database. Spring Batch provides a `Neo4jItemWriterBuilder` to construct an instance of the `Neo4jItemWriter`.

MongoItemWriter

The `MongoItemWriter` is an `ItemWriter` implementation that writes to a MongoDB store using an implementation of Spring Data's `MongoOperations`. Spring Batch provides a `MongoItemWriterBuilder` to construct an instance of the `MongoItemWriter`.

RepositoryItemWriter

The `RepositoryItemWriter` is an `ItemWriter` wrapper for a `CrudRepository` from Spring Data. Spring Batch provides a `RepositoryItemWriterBuilder` to construct an instance of the `RepositoryItemWriter`.

HibernateItemWriter

The `HibernateItemWriter` is an `ItemWriter` that uses a Hibernate session to save or update entities that are not part of the current Hibernate session. Spring Batch provides a `HibernateItemWriterBuilder` to construct an instance of the `HibernateItemWriter`.

JdbcBatchItemWriter

The `JdbcBatchItemWriter` is an `ItemWriter` that uses the batching features from `NamedParameterJdbcTemplate` to execute a batch of statements for all items provided. Spring Batch provides a `JdbcBatchItemWriterBuilder` to construct an instance of the `JdbcBatchItemWriter`.

JpaItemWriter

The `JpaItemWriter` is an `ItemWriter` that uses a JPA `EntityManagerFactory` to merge any entities that are not part of the persistence context. Spring Batch provides a `JpaItemWriterBuilder` to construct an instance of the `JpaItemWriter`.

GemfireItemWriter

The `GemfireItemWriter` is an `ItemWriter` that uses a `GemfireTemplate` that stores items in GemFire as key/value pairs. Spring Batch provides a `GemfireItemWriterBuilder` to construct an instance of the `GemfireItemWriter`.

6.15.5. Specialized Readers

Spring Batch offers the following specialized readers:

- `LdifReader`
- `MappingLdifReader`
- `AvroItemReader`

LdifReader

The `LdifReader` reads LDIF (LDAP Data Interchange Format) records from a `Resource`, parses them, and returns a `LdapAttribute` object for each `read` executed. Spring Batch provides a `LdifReaderBuilder` to construct an instance of the `LdifReader`.

MappingLdifReader

The `MappingLdifReader` reads LDIF (LDAP Data Interchange Format) records from a `Resource`, parses them then maps each LDIF record to a POJO (Plain Old Java Object). Each `read` returns a POJO. Spring Batch provides a `MappingLdifReaderBuilder` to construct an instance of the `MappingLdifReader`.

AvroItemReader

The `AvroItemReader` reads serialized Avro data from a `Resource`. Each `read` returns an instance of the type specified by a Java class or Avro Schema. The reader may be optionally configured for input that embeds an Avro schema or not. Spring Batch provides an `AvroItemReaderBuilder` to construct an instance of the `AvroItemReader`.

6.15.6. Specialized Writers

Spring Batch offers the following specialized writers:

- `SimpleMailMessageItemWriter`
- `AvroItemWriter`

SimpleMailMessageItemWriter

The `SimpleMailMessageItemWriter` is an `ItemWriter` that can send mail messages. It delegates the actual sending of messages to an instance of `MailSender`. Spring Batch provides a `SimpleMailMessageItemWriterBuilder` to construct an instance of the `SimpleMailMessageItemWriter`.

AvroItemWriter

The `AvroItemWriter` serializes Java objects to a `WritableResource` according to the given type or Schema. The writer may be optionally configured to embed an Avro schema in the output or not. Spring Batch provides an `AvroItemWriterBuilder` to construct an instance of the `AvroItemWriter`.

6.15.7. Specialized Processors

Spring Batch offers the following specialized processors:

- `ScriptItemProcessor`

`ScriptItemProcessor`

The `ScriptItemProcessor` is an `ItemProcessor` that passes the current item to process to the provided script and the result of the script is returned by the processor. Spring Batch provides a `ScriptItemProcessorBuilder` to construct an instance of the `ScriptItemProcessor`.

Chapter 7. Scaling and Parallel Processing

Many batch processing problems can be solved with single threaded, single process jobs, so it is always a good idea to properly check if that meets your needs before thinking about more complex implementations. Measure the performance of a realistic job and see if the simplest implementation meets your needs first. You can read and write a file of several hundred megabytes in well under a minute, even with standard hardware.

When you are ready to start implementing a job with some parallel processing, Spring Batch offers a range of options, which are described in this chapter, although some features are covered elsewhere. At a high level, there are two modes of parallel processing:

- Single process, multi-threaded
- Multi-process

These break down into categories as well, as follows:

- Multi-threaded Step (single process)
- Parallel Steps (single process)
- Remote Chunking of Step (multi process)
- Partitioning a Step (single or multi process)

First, we review the single-process options. Then we review the multi-process options.

7.1. Multi-threaded Step

The simplest way to start parallel processing is to add a `TaskExecutor` to your Step configuration.

For example, you might add an attribute of the `tasklet`, as shown in the following example:

```
<step id="loading">
  <tasklet task-executor="taskExecutor">...</tasklet>
</step>
```

When using java configuration, a `TaskExecutor` can be added to the step as shown in the following example:

```
@Bean
public TaskExecutor taskExecutor(){
    return new SimpleAsyncTaskExecutor("spring_batch");
}

@Bean
public Step sampleStep(TaskExecutor taskExecutor) {
    return this.stepBuilderFactory.get("sampleStep")
        .<String, String>chunk(10)
        .reader(itemReader())
        .writer(itemWriter())
        .taskExecutor(taskExecutor)
        .build();
}
```

In this example, the `taskExecutor` is a reference to another bean definition that implements the `TaskExecutor` interface. `TaskExecutor` is a standard Spring interface, so consult the Spring User Guide for details of available implementations. The simplest multi-threaded `TaskExecutor` is a `SimpleAsyncTaskExecutor`.

The result of the above configuration is that the `Step` executes by reading, processing, and writing each chunk of items (each commit interval) in a separate thread of execution. Note that this means there is no fixed order for the items to be processed, and a chunk might contain items that are non-consecutive compared to the single-threaded case. In addition to any limits placed by the task executor (such as whether it is backed by a thread pool), there is a throttle limit in the tasklet configuration which defaults to 4. You may need to increase this to ensure that a thread pool is fully utilized.

For example you might increase the throttle-limit, as shown in the following example:

```
<step id="loading"> <tasklet
    task-executor="taskExecutor"
    throttle-limit="20">...</tasklet>
</step>
```

When using java configuration, the builders provide access to the throttle limit:

```

@Bean
public Step sampleStep(TaskExecutor taskExecutor) {
    return this.stepBuilderFactory.get("sampleStep")
        .<String, String>chunk(10)
        .reader(itemReader())
        .writer(itemWriter())
        .taskExecutor(taskExecutor)
        .throttleLimit(20)
        .build();
}

```

Note also that there may be limits placed on concurrency by any pooled resources used in your step, such as a [DataSource](#). Be sure to make the pool in those resources at least as large as the desired number of concurrent threads in the step.

There are some practical limitations of using multi-threaded [Step](#) implementations for some common batch use cases. Many participants in a [Step](#) (such as readers and writers) are stateful. If the state is not segregated by thread, then those components are not usable in a multi-threaded [Step](#). In particular, most of the off-the-shelf readers and writers from Spring Batch are not designed for multi-threaded use. It is, however, possible to work with stateless or thread safe readers and writers, and there is a sample (called [parallelJob](#)) in the [Spring Batch Samples](#) that shows the use of a process indicator (see [Preventing State Persistence](#)) to keep track of items that have been processed in a database input table.

Spring Batch provides some implementations of [ItemWriter](#) and [ItemReader](#). Usually, they say in the Javadoc if they are thread safe or not or what you have to do to avoid problems in a concurrent environment. If there is no information in the Javadoc, you can check the implementation to see if there is any state. If a reader is not thread safe, you can decorate it with the provided [SynchronizedItemStreamReader](#) or use it in your own synchronizing delegator. You can synchronize the call to [read\(\)](#) and as long as the processing and writing is the most expensive part of the chunk, your step may still complete much faster than it would in a single threaded configuration.

7.2. Parallel Steps

As long as the application logic that needs to be parallelized can be split into distinct responsibilities and assigned to individual steps, then it can be parallelized in a single process. Parallel Step execution is easy to configure and use.

For example, executing steps ([step1, step2](#)) in parallel with [step3](#) is straightforward, as shown in the following example:

```
<job id="job1">
  <split id="split1" task-executor="taskExecutor" next="step4">
    <flow>
      <step id="step1" parent="s1" next="step2"/>
      <step id="step2" parent="s2"/>
    </flow>
    <flow>
      <step id="step3" parent="s3"/>
    </flow>
  </split>
  <step id="step4" parent="s4"/>
</job>

<beans:bean id="taskExecutor" class="org.spr...SimpleAsyncTaskExecutor"/>
```

When using java configuration, executing steps (step1,step2) in parallel with step3 is straightforward, as shown in the following example:

```

@Bean
public Job job() {
    return jobBuilderFactory.get("job")
        .start(splitFlow())
        .next(step4())
        .build()           //builds FlowJobBuilder instance
        .build();         //builds Job instance
}

@Bean
public Flow splitFlow() {
    return new FlowBuilder<SimpleFlow>("splitFlow")
        .split(taskExecutor())
        .add(flow1(), flow2())
        .build();
}

@Bean
public Flow flow1() {
    return new FlowBuilder<SimpleFlow>("flow1")
        .start(step1())
        .next(step2())
        .build();
}

@Bean
public Flow flow2() {
    return new FlowBuilder<SimpleFlow>("flow2")
        .start(step3())
        .build();
}

@Bean
public TaskExecutor taskExecutor(){
    return new SimpleAsyncTaskExecutor("spring_batch");
}

```

The configurable task executor is used to specify which `TaskExecutor` implementation should be used to execute the individual flows. The default is `SyncTaskExecutor`, but an asynchronous `TaskExecutor` is required to run the steps in parallel. Note that the job ensures that every flow in the split completes before aggregating the exit statuses and transitioning.

See the section on [Split Flows](#) for more detail.

7.3. Remote Chunking

In remote chunking, the `Step` processing is split across multiple processes, communicating with each other through some middleware. The following image shows the pattern:

Remote Chunking

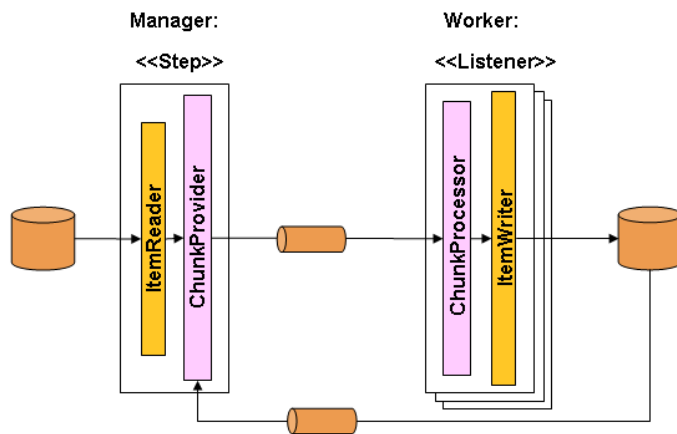

Figure 22. Remote Chunking

The manager component is a single process, and the workers are multiple remote processes. This pattern works best if the manager is not a bottleneck, so the processing must be more expensive than the reading of items (as is often the case in practice).

The manager is an implementation of a Spring Batch `Step` with the `ItemWriter` replaced by a generic version that knows how to send chunks of items to the middleware as messages. The workers are standard listeners for whatever middleware is being used (for example, with JMS, they would be `MessageListener` implementations), and their role is to process the chunks of items using a standard `ItemWriter` or `ItemProcessor` plus `ItemWriter`, through the `ChunkProcessor` interface. One of the advantages of using this pattern is that the reader, processor, and writer components are off-the-shelf (the same as would be used for a local execution of the step). The items are divided up dynamically and work is shared through the middleware, so that, if the listeners are all eager consumers, then load balancing is automatic.

The middleware has to be durable, with guaranteed delivery and a single consumer for each message. JMS is the obvious candidate, but other options (such as JavaSpaces) exist in the grid computing and shared memory product space.

See the section on [Spring Batch Integration - Remote Chunking](#) for more detail.

7.4. Partitioning

Spring Batch also provides an SPI for partitioning a `Step` execution and executing it remotely. In this case, the remote participants are `Step` instances that could just as easily have been configured and used for local processing. The following image shows the pattern:

Partitioning Overview

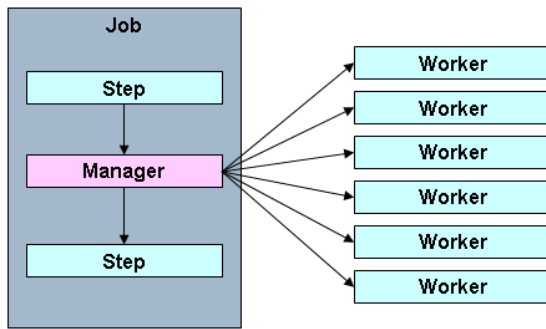

Figure 23. Partitioning

The **Job** runs on the left-hand side as a sequence of **Step** instances, and one of the **Step** instances is labeled as a manager. The workers in this picture are all identical instances of a **Step**, which could in fact take the place of the manager, resulting in the same outcome for the **Job**. The workers are typically going to be remote services but could also be local threads of execution. The messages sent by the manager to the workers in this pattern do not need to be durable or have guaranteed delivery. Spring Batch metadata in the **JobRepository** ensures that each worker is executed once and only once for each **Job** execution.

The SPI in Spring Batch consists of a special implementation of **Step** (called the **PartitionStep**) and two strategy interfaces that need to be implemented for the specific environment. The strategy interfaces are **PartitionHandler** and **StepExecutionSplitter**, and their role is shown in the following sequence diagram:

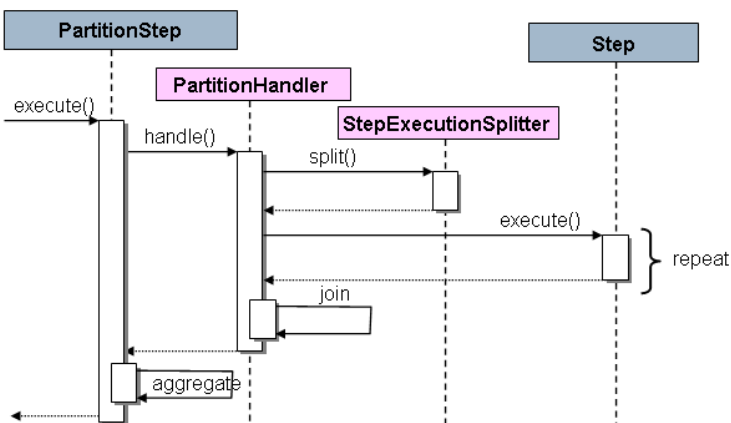

Figure 24. Partitioning SPI

The **Step** on the right in this case is the “remote” worker, so, potentially, there are many objects and or processes playing this role, and the **PartitionStep** is shown driving the execution.

The following example shows the `PartitionStep` configuration:

```
<step id="step1.manager">
  <partition step="step1" partitioner="partitioner">
    <handler grid-size="10" task-executor="taskExecutor"/>
  </partition>
</step>
```

The following example shows the `PartitionStep` configuration using java configuration:

Java Configuration

```
@Bean
public Step step1Manager() {
    return stepBuilderFactory.get("step1.manager")
        .<String, String>partitioner("step1", partitioner())
        .step(step1())
        .gridSize(10)
        .taskExecutor(taskExecutor())
        .build();
}
```

Similar to the multi-threaded step's `throttle-limit` attribute, the `grid-size` attribute prevents the task executor from being saturated with requests from a single step.

There is a simple example that can be copied and extended in the unit test suite for [Spring Batch Samples](#) (see `Partition*Job.xml` configuration).

Spring Batch creates step executions for the partitions called "step1:partition0", and so on. Many people prefer to call the manager step "step1:manager" for consistency. You can use an alias for the step (by specifying the `name` attribute instead of the `id` attribute).

7.4.1. PartitionHandler

The `PartitionHandler` is the component that knows about the fabric of the remoting or grid environment. It is able to send `StepExecution` requests to the remote `Step` instances, wrapped in some fabric-specific format, like a DTO. It does not have to know how to split the input data or how to aggregate the result of multiple `Step` executions. Generally speaking, it probably also does not need to know about resilience or failover, since those are features of the fabric in many cases. In any case, Spring Batch always provides restartability independent of the fabric. A failed `Job` can always be restarted and only the failed `Steps` are re-executed.

The `PartitionHandler` interface can have specialized implementations for a variety of fabric types, including simple RMI remoting, EJB remoting, custom web service, JMS, Java Spaces, shared memory grids (like Terracotta or Coherence), and grid execution fabrics (like GridGain). Spring Batch does not contain implementations for any proprietary grid or remoting fabrics.

Spring Batch does, however, provide a useful implementation of `PartitionHandler` that executes `Step` instances locally in separate threads of execution, using the `TaskExecutor` strategy from Spring.

The implementation is called `TaskExecutorPartitionHandler`.

The `TaskExecutorPartitionHandler` is the default for a step configured with the XML namespace shown previously. It can also be configured explicitly, as shown in the following example:

```
<step id="step1.manager">
  <partition step="step1" handler="handler"/>
</step>

<bean class="org.spr...TaskExecutorPartitionHandler">
  <property name="taskExecutor" ref="taskExecutor"/>
  <property name="step" ref="step1" />
  <property name="gridSize" value="10" />
</bean>
```

The `TaskExecutorPartitionHandler` can be configured explicitly within java configuration, as shown in the following example:

Java Configuration

```
@Bean
public Step step1Manager() {
    return stepBuilderFactory.get("step1.manager")
        .partitioner("step1", partitioner())
        .partitionHandler(partitionHandler())
        .build();
}

@Bean
public PartitionHandler partitionHandler() {
    TaskExecutorPartitionHandler retVal = new TaskExecutorPartitionHandler();
    retVal.setTaskExecutor(taskExecutor());
    retVal.setStep(step1());
    retVal.setGridSize(10);
    return retVal;
}
```

The `gridSize` attribute determines the number of separate step executions to create, so it can be matched to the size of the thread pool in the `TaskExecutor`. Alternatively, it can be set to be larger than the number of threads available, which makes the blocks of work smaller.

The `TaskExecutorPartitionHandler` is useful for IO-intensive `Step` instances, such as copying large numbers of files or replicating filesystems into content management systems. It can also be used for remote execution by providing a `Step` implementation that is a proxy for a remote invocation (such as using Spring Remoting).

7.4.2. Partitioner

The `Partitioner` has a simpler responsibility: to generate execution contexts as input parameters

for new step executions only (no need to worry about restarts). It has a single method, as shown in the following interface definition:

```
public interface Partitioner {
    Map<String, ExecutionContext> partition(int gridSize);
}
```

The return value from this method associates a unique name for each step execution (the `String`) with input parameters in the form of an `ExecutionContext`. The names show up later in the Batch metadata as the step name in the partitioned `StepExecutions`. The `ExecutionContext` is just a bag of name-value pairs, so it might contain a range of primary keys, line numbers, or the location of an input file. The remote `Step` then normally binds to the context input using `#{...}` placeholders (late binding in step scope), as illustrated in the next section.

The names of the step executions (the keys in the `Map` returned by `Partitioner`) need to be unique amongst the step executions of a `Job` but do not have any other specific requirements. The easiest way to do this (and to make the names meaningful for users) is to use a prefix+suffix naming convention, where the prefix is the name of the step that is being executed (which itself is unique in the `Job`), and the suffix is just a counter. There is a `SimplePartitioner` in the framework that uses this convention.

An optional interface called `PartitionNameProvider` can be used to provide the partition names separately from the partitions themselves. If a `Partitioner` implements this interface, then, on a restart, only the names are queried. If partitioning is expensive, this can be a useful optimization. The names provided by the `PartitionNameProvider` must match those provided by the `Partitioner`.

7.4.3. Binding Input Data to Steps

It is very efficient for the steps that are executed by the `PartitionHandler` to have identical configuration and for their input parameters to be bound at runtime from the `ExecutionContext`. This is easy to do with the StepScope feature of Spring Batch (covered in more detail in the section on `Late Binding`). For example, if the `Partitioner` creates `ExecutionContext` instances with an attribute key called `fileName`, pointing to a different file (or directory) for each step invocation, the `Partitioner` output might resemble the content of the following table:

Table 17. Example step execution name to execution context provided by `Partitioner` targeting directory processing

Step Execution Name (key)	ExecutionContext (value)
filecopy:partition0	fileName=/home/data/one
filecopy:partition1	fileName=/home/data/two
filecopy:partition2	fileName=/home/data/three

Then the file name can be bound to a step using late binding to the execution context, as shown in the following example:

XML Configuration

```
<bean id="itemReader" scope="step"
      class="org.spr...MultiResourceItemReader">
  <property name="resources" value="#{stepExecutionContext[fileName]}/*" />
</bean>
```

Java Configuration

```
@Bean
public MultiResourceItemReader itemReader(
    @Value("#{stepExecutionContext['fileName']}/*") Resource [] resources) {
    return new MultiResourceItemReaderBuilder<String>()
        .delegate(fileReader())
        .name("itemReader")
        .resources(resources)
        .build();
}
```

Chapter 8. Repeat

8.1. RepeatTemplate

Batch processing is about repetitive actions, either as a simple optimization or as part of a job. To strategize and generalize the repetition and to provide what amounts to an iterator framework, Spring Batch has the `RepeatOperations` interface. The `RepeatOperations` interface has the following definition:

```
public interface RepeatOperations {  
    RepeatStatus iterate(RepeatCallback callback) throws RepeatException;  
}
```

The callback is an interface, shown in the following definition, that lets you insert some business logic to be repeated:

```
public interface RepeatCallback {  
    RepeatStatus doInIteration(RepeatContext context) throws Exception;  
}
```

The callback is executed repeatedly until the implementation determines that the iteration should end. The return value in these interfaces is an enumeration that can either be `RepeatStatus.CONTINUABLE` or `RepeatStatus.FINISHED`. A `RepeatStatus` enumeration conveys information to the caller of the repeat operations about whether there is any more work to do. Generally speaking, implementations of `RepeatOperations` should inspect the `RepeatStatus` and use it as part of the decision to end the iteration. Any callback that wishes to signal to the caller that there is no more work to do can return `RepeatStatus.FINISHED`.

The simplest general purpose implementation of `RepeatOperations` is `RepeatTemplate`, as shown in the following example:

```

RepeatTemplate template = new RepeatTemplate();

template.setCompletionPolicy(new SimpleCompletionPolicy(2));

template.iterate(new RepeatCallback() {

    public RepeatStatus doInIteration(RepeatContext context) {
        // Do stuff in batch...
        return RepeatStatus.CONTINUABLE;
    }

});

```

In the preceding example, we return `RepeatStatus.CONTINUABLE`, to show that there is more work to do. The callback can also return `RepeatStatus.FINISHED`, to signal to the caller that there is no more work to do. Some iterations can be terminated by considerations intrinsic to the work being done in the callback. Others are effectively infinite loops as far as the callback is concerned and the completion decision is delegated to an external policy, as in the case shown in the preceding example.

8.1.1. RepeatContext

The method parameter for the `RepeatCallback` is a `RepeatContext`. Many callbacks ignore the context. However, if necessary, it can be used as an attribute bag to store transient data for the duration of the iteration. After the `iterate` method returns, the context no longer exists.

If there is a nested iteration in progress, a `RepeatContext` has a parent context. The parent context is occasionally useful for storing data that need to be shared between calls to `iterate`. This is the case, for instance, if you want to count the number of occurrences of an event in the iteration and remember it across subsequent calls.

8.1.2. RepeatStatus

`RepeatStatus` is an enumeration used by Spring Batch to indicate whether processing has finished. It has two possible `RepeatStatus` values, described in the following table:

Table 18. *RepeatStatus Properties*

<i>Value</i>	<i>Description</i>
CONTINUABLE	There is more work to do.
FINISHED	No more repetitions should take place.

`RepeatStatus` values can also be combined with a logical AND operation by using the `and()` method in `RepeatStatus`. The effect of this is to do a logical AND on the continuable flag. In other words, if either status is `FINISHED`, then the result is `FINISHED`.

8.2. Completion Policies

Inside a `RepeatTemplate`, the termination of the loop in the `iterate` method is determined by a `CompletionPolicy`, which is also a factory for the `RepeatContext`. The `RepeatTemplate` has the responsibility to use the current policy to create a `RepeatContext` and pass that in to the `RepeatCallback` at every stage in the iteration. After a callback completes its `doInIteration`, the `RepeatTemplate` has to make a call to the `CompletionPolicy` to ask it to update its state (which will be stored in the `RepeatContext`). Then it asks the policy if the iteration is complete.

Spring Batch provides some simple general purpose implementations of `CompletionPolicy`. `SimpleCompletionPolicy` allows execution up to a fixed number of times (with `RepeatStatus.FINISHED` forcing early completion at any time).

Users might need to implement their own completion policies for more complicated decisions. For example, a batch processing window that prevents batch jobs from executing once the online systems are in use would require a custom policy.

8.3. Exception Handling

If there is an exception thrown inside a `RepeatCallback`, the `RepeatTemplate` consults an `ExceptionHandler`, which can decide whether or not to re-throw the exception.

The following listing shows the `ExceptionHandler` interface definition:

```
public interface ExceptionHandler {  
  
    void handleException(RepeatContext context, Throwable throwable)  
        throws Throwable;  
  
}
```

A common use case is to count the number of exceptions of a given type and fail when a limit is reached. For this purpose, Spring Batch provides the `SimpleLimitExceptionHandler` and a slightly more flexible `RethrowOnThresholdExceptionHandler`. The `SimpleLimitExceptionHandler` has a limit property and an exception type that should be compared with the current exception. All subclasses of the provided type are also counted. Exceptions of the given type are ignored until the limit is reached, and then they are rethrown. Exceptions of other types are always rethrown.

An important optional property of the `SimpleLimitExceptionHandler` is the boolean flag called `useParent`. It is `false` by default, so the limit is only accounted for in the current `RepeatContext`. When set to `true`, the limit is kept across sibling contexts in a nested iteration (such as a set of chunks inside a step).

8.4. Listeners

Often, it is useful to be able to receive additional callbacks for cross-cutting concerns across a number of different iterations. For this purpose, Spring Batch provides the `RepeatListener` interface.

The `RepeatTemplate` lets users register `RepeatListener` implementations, and they are given callbacks with the `RepeatContext` and `RepeatStatus` where available during the iteration.

The `RepeatListener` interface has the following definition:

```
public interface RepeatListener {
    void before(RepeatContext context);
    void after(RepeatContext context, RepeatStatus result);
    void open(RepeatContext context);
    void onError(RepeatContext context, Throwable e);
    void close(RepeatContext context);
}
```

The `open` and `close` callbacks come before and after the entire iteration. `before`, `after`, and `onError` apply to the individual `RepeatCallback` calls.

Note that, when there is more than one listener, they are in a list, so there is an order. In this case, `open` and `before` are called in the same order while `after`, `onError`, and `close` are called in reverse order.

8.5. Parallel Processing

Implementations of `RepeatOperations` are not restricted to executing the callback sequentially. It is quite important that some implementations are able to execute their callbacks in parallel. To this end, Spring Batch provides the `TaskExecutorRepeatTemplate`, which uses the Spring `TaskExecutor` strategy to run the `RepeatCallback`. The default is to use a `SynchronousTaskExecutor`, which has the effect of executing the whole iteration in the same thread (the same as a normal `RepeatTemplate`).

8.6. Declarative Iteration

Sometimes there is some business processing that you know you want to repeat every time it happens. The classic example of this is the optimization of a message pipeline. It is more efficient to process a batch of messages, if they are arriving frequently, than to bear the cost of a separate transaction for every message. Spring Batch provides an AOP interceptor that wraps a method call in a `RepeatOperations` object for just this purpose. The `RepeatOperationsInterceptor` executes the intercepted method and repeats according to the `CompletionPolicy` in the provided `RepeatTemplate`.

The following example shows declarative iteration using the Spring AOP namespace to repeat a service call to a method called `processMessage` (for more detail on how to configure AOP interceptors, see the Spring User Guide):

```

<aop:config>
  <aop:pointcut id="transactional"
    expression="execution(* com.*Service.processMessage(..))" />
  <aop:advisor pointcut-ref="transactional"
    advice-ref="retryAdvice" order="-1"/>
</aop:config>

<bean id="retryAdvice" class="org.spr...RepeatOperationsInterceptor"/>

```

The following example demonstrates using java configuration to repeat a service call to a method called `processMessage` (for more detail on how to configure AOP interceptors, see the Spring User Guide):

```

@Bean
public MyService myService() {
    ProxyFactory factory = new ProxyFactory(RepeatOperations.class.getClassLoader());
    factory.setInterfaces(MyService.class);
    factory.setTarget(new MyService());

    MyService service = (MyService) factory.getProxy();
    JdkRegexpMethodPointcut pointcut = new JdkRegexpMethodPointcut();
    pointcut.setPatterns(".*processMessage.*");

    RepeatOperationsInterceptor interceptor = new RepeatOperationsInterceptor();

    ((Advised) service).addAdvisor(new DefaultPointcutAdvisor(pointcut, interceptor));

    return service;
}

```

The preceding example uses a default `RepeatTemplate` inside the interceptor. To change the policies, listeners, and other details, you can inject an instance of `RepeatTemplate` into the interceptor.

If the intercepted method returns `void`, then the interceptor always returns `RepeatStatus.CONTINUABLE` (so there is a danger of an infinite loop if the `CompletionPolicy` does not have a finite end point). Otherwise, it returns `RepeatStatus.CONTINUABLE` until the return value from the intercepted method is `null`, at which point it returns `RepeatStatus.FINISHED`. Consequently, the business logic inside the target method can signal that there is no more work to do by returning `null` or by throwing an exception that is re-thrown by the `ExceptionHandler` in the provided `RepeatTemplate`.

Chapter 9. Retry

To make processing more robust and less prone to failure, it sometimes helps to automatically retry a failed operation in case it might succeed on a subsequent attempt. Errors that are susceptible to intermittent failure are often transient in nature. Examples include remote calls to a web service that fails because of a network glitch or a `DeadlockLoserDataAccessException` in a database update.

9.1. RetryTemplate



The retry functionality was pulled out of Spring Batch as of 2.2.0. It is now part of a new library, [Spring Retry](#).

To automate retry operations Spring Batch has the `RetryOperations` strategy. The following interface definition for `RetryOperations`:

```
public interface RetryOperations {

    <T, E extends Throwable> T execute(RetryCallback<T, E> retryCallback) throws E;

    <T, E extends Throwable> T execute(RetryCallback<T, E> retryCallback,
    RecoveryCallback<T> recoveryCallback)
        throws E;

    <T, E extends Throwable> T execute(RetryCallback<T, E> retryCallback, RetryState
    retryState)
        throws E, ExhaustedRetryException;

    <T, E extends Throwable> T execute(RetryCallback<T, E> retryCallback,
    RecoveryCallback<T> recoveryCallback,
        RetryState retryState) throws E;

}
```

The basic callback is a simple interface that lets you insert some business logic to be retried, as shown in the following interface definition:

```
public interface RetryCallback<T, E extends Throwable> {

    T doWithRetry(RetryContext context) throws E;

}
```

The callback runs and, if it fails (by throwing an `Exception`), it is retried until either it is successful or the implementation aborts. There are a number of overloaded `execute` methods in the `RetryOperations` interface. Those methods deal with various use cases for recovery when all retry attempts are exhausted and deal with retry state, which allows clients and implementations to store

information between calls (we cover this in more detail later in the chapter).

The simplest general purpose implementation of `RetryOperations` is `RetryTemplate`. It can be used as follows:

```
RetryTemplate template = new RetryTemplate();

TimeoutRetryPolicy policy = new TimeoutRetryPolicy();
policy.setTimeout(30000L);

template.setRetryPolicy(policy);

Foo result = template.execute(new RetryCallback<Foo>() {

    public Foo doWithRetry(RetryContext context) {
        // Do stuff that might fail, e.g. webservice operation
        return result;
    }

});
```

In the preceding example, we make a web service call and return the result to the user. If that call fails, then it is retried until a timeout is reached.

9.1.1. `RetryContext`

The method parameter for the `RetryCallback` is a `RetryContext`. Many callbacks ignore the context, but, if necessary, it can be used as an attribute bag to store data for the duration of the iteration.

A `RetryContext` has a parent context if there is a nested retry in progress in the same thread. The parent context is occasionally useful for storing data that need to be shared between calls to `execute`.

9.1.2. `RecoveryCallback`

When a retry is exhausted, the `RetryOperations` can pass control to a different callback, called the `RecoveryCallback`. To use this feature, clients pass in the callbacks together to the same method, as shown in the following example:

```
Foo foo = template.execute(new RetryCallback<Foo>() {
    public Foo doWithRetry(RetryContext context) {
        // business logic here
    },
    new RecoveryCallback<Foo>() {
        Foo recover(RetryContext context) throws Exception {
            // recover logic here
        }
    }
});
```

If the business logic does not succeed before the template decides to abort, then the client is given the chance to do some alternate processing through the recovery callback.

9.1.3. Stateless Retry

In the simplest case, a retry is just a while loop. The `RetryTemplate` can just keep trying until it either succeeds or fails. The `RetryContext` contains some state to determine whether to retry or abort, but this state is on the stack and there is no need to store it anywhere globally, so we call this stateless retry. The distinction between stateless and stateful retry is contained in the implementation of the `RetryPolicy` (the `RetryTemplate` can handle both). In a stateless retry, the retry callback is always executed in the same thread it was on when it failed.

9.1.4. Stateful Retry

Where the failure has caused a transactional resource to become invalid, there are some special considerations. This does not apply to a simple remote call because there is no transactional resource (usually), but it does sometimes apply to a database update, especially when using Hibernate. In this case it only makes sense to re-throw the exception that caused the failure immediately, so that the transaction can roll back and we can start a new, valid transaction.

In cases involving transactions, a stateless retry is not good enough, because the re-throw and roll back necessarily involve leaving the `RetryOperations.execute()` method and potentially losing the context that was on the stack. To avoid losing it we have to introduce a storage strategy to lift it off the stack and put it (at a minimum) in heap storage. For this purpose, Spring Batch provides a storage strategy called `RetryContextCache`, which can be injected into the `RetryTemplate`. The default implementation of the `RetryContextCache` is in memory, using a simple `Map`. Advanced usage with multiple processes in a clustered environment might also consider implementing the `RetryContextCache` with a cluster cache of some sort (however, even in a clustered environment, this might be overkill).

Part of the responsibility of the `RetryOperations` is to recognize the failed operations when they come back in a new execution (and usually wrapped in a new transaction). To facilitate this, Spring Batch provides the `RetryState` abstraction. This works in conjunction with a special `execute` methods in the `RetryOperations` interface.

The way the failed operations are recognized is by identifying the state across multiple invocations of the retry. To identify the state, the user can provide a `RetryState` object that is responsible for returning a unique key identifying the item. The identifier is used as a key in the `RetryContextCache` interface.



Be very careful with the implementation of `Object.equals()` and `Object.hashCode()` in the key returned by `RetryState`. The best advice is to use a business key to identify the items. In the case of a JMS message, the message ID can be used.

When the retry is exhausted, there is also the option to handle the failed item in a different way, instead of calling the `RetryCallback` (which is now presumed to be likely to fail). Just like in the stateless case, this option is provided by the `RecoveryCallback`, which can be provided by passing it in to the `execute` method of `RetryOperations`.

The decision to retry or not is actually delegated to a regular `RetryPolicy`, so the usual concerns about limits and timeouts can be injected there (described later in this chapter).

9.2. Retry Policies

Inside a `RetryTemplate`, the decision to retry or fail in the `execute` method is determined by a `RetryPolicy`, which is also a factory for the `RetryContext`. The `RetryTemplate` has the responsibility to use the current policy to create a `RetryContext` and pass that in to the `RetryCallback` at every attempt. After a callback fails, the `RetryTemplate` has to make a call to the `RetryPolicy` to ask it to update its state (which is stored in the `RetryContext`) and then asks the policy if another attempt can be made. If another attempt cannot be made (such as when a limit is reached or a timeout is detected) then the policy is also responsible for handling the exhausted state. Simple implementations throw `RetryExhaustedException`, which causes any enclosing transaction to be rolled back. More sophisticated implementations might attempt to take some recovery action, in which case the transaction can remain intact.



Failures are inherently either retryable or not. If the same exception is always going to be thrown from the business logic, it does no good to retry it. So do not retry on all exception types. Rather, try to focus on only those exceptions that you expect to be retryable. It is not usually harmful to the business logic to retry more aggressively, but it is wasteful, because, if a failure is deterministic, you spend time retrying something that you know in advance is fatal.

Spring Batch provides some simple general purpose implementations of stateless `RetryPolicy`, such as `SimpleRetryPolicy` and `TimeoutRetryPolicy` (used in the preceding example).

The `SimpleRetryPolicy` allows a retry on any of a named list of exception types, up to a fixed number of times. It also has a list of "fatal" exceptions that should never be retried, and this list overrides the retryable list so that it can be used to give finer control over the retry behavior, as shown in the following example:

```
SimpleRetryPolicy policy = new SimpleRetryPolicy();
// Set the max retry attempts
policy.setMaxAttempts(5);
// Retry on all exceptions (this is the default)
policy.setRetryableExceptions(new Class[] {Exception.class});
// ... but never retry IllegalStateException
policy.setFatalExceptions(new Class[] {IllegalStateException.class});

// Use the policy...
RetryTemplate template = new RetryTemplate();
template.setRetryPolicy(policy);
template.execute(new RetryCallback<Foo>() {
    public Foo doWithRetry(RetryContext context) {
        // business logic here
    }
});
```

There is also a more flexible implementation called `ExceptionClassifierRetryPolicy`, which allows the user to configure different retry behavior for an arbitrary set of exception types through the `ExceptionClassifier` abstraction. The policy works by calling on the classifier to convert an exception into a delegate `RetryPolicy`. For example, one exception type can be retried more times before failure than another by mapping it to a different policy.

Users might need to implement their own retry policies for more customized decisions. For instance, a custom retry policy makes sense when there is a well-known, solution-specific classification of exceptions into retryable and not retryable.

9.3. Backoff Policies

When retrying after a transient failure, it often helps to wait a bit before trying again, because usually the failure is caused by some problem that can only be resolved by waiting. If a `RetryCallback` fails, the `RetryTemplate` can pause execution according to the `BackoffPolicy`.

The following code shows the interface definition for the `BackOffPolicy` interface:

```
public interface BackoffPolicy {  
  
    BackOffContext start(RetryContext context);  
  
    void backOff(BackOffContext backOffContext)  
        throws BackOffInterruptedException;  
  
}
```

A `BackoffPolicy` is free to implement the `backOff` in any way it chooses. The policies provided by Spring Batch out of the box all use `Object.wait()`. A common use case is to backoff with an exponentially increasing wait period, to avoid two retries getting into lock step and both failing (this is a lesson learned from ethernet). For this purpose, Spring Batch provides the `ExponentialBackoffPolicy`.

9.4. Listeners

Often, it is useful to be able to receive additional callbacks for cross cutting concerns across a number of different retries. For this purpose, Spring Batch provides the `RetryListener` interface. The `RetryTemplate` lets users register `RetryListeners`, and they are given callbacks with `RetryContext` and `Throwable` where available during the iteration.

The following code shows the interface definition for `RetryListener`:

```

public interface RetryListener {

    <T, E extends Throwable> boolean open(RetryContext context, RetryCallback<T, E>
callback);

    <T, E extends Throwable> void onError(RetryContext context, RetryCallback<T, E>
callback, Throwable throwable);

    <T, E extends Throwable> void close(RetryContext context, RetryCallback<T, E>
callback, Throwable throwable);
}

```

The `open` and `close` callbacks come before and after the entire retry in the simplest case, and `onError` applies to the individual `RetryCallback` calls. The `close` method might also receive a `Throwable`. If there has been an error, it is the last one thrown by the `RetryCallback`.

Note that, when there is more than one listener, they are in a list, so there is an order. In this case, `open` is called in the same order while `onError` and `close` are called in reverse order.

9.5. Declarative Retry

Sometimes, there is some business processing that you know you want to retry every time it happens. The classic example of this is the remote service call. Spring Batch provides an AOP interceptor that wraps a method call in a `RetryOperations` implementation for just this purpose. The `RetryOperationsInterceptor` executes the intercepted method and retries on failure according to the `RetryPolicy` in the provided `RetryTemplate`.

The following example shows a declarative retry that uses the Spring AOP namespace to retry a service call to a method called `remoteCall` (for more detail on how to configure AOP interceptors, see the Spring User Guide):

```

<aop:config>
  <aop:pointcut id="transactional"
    expression="execution(* com.*Service.remoteCall(..))" />
  <aop:advisor pointcut-ref="transactional"
    advice-ref="retryAdvice" order="-1"/>
</aop:config>

<bean id="retryAdvice"
  class="org.springframework.retry.interceptor.RetryOperationsInterceptor"/>

```

The following example shows a declarative retry that uses java configuration to retry a service call to a method called `remoteCall` (for more detail on how to configure AOP interceptors, see the Spring User Guide):

```

@Bean
public MyService myService() {
    ProxyFactory factory = new ProxyFactory(RepeatOperations.class.getClassLoader());
    factory.setInterfaces(MyService.class);
    factory.setTarget(new MyService());

    MyService service = (MyService) factory.getProxy();
    JdkRegexpMethodPointcut pointcut = new JdkRegexpMethodPointcut();
    pointcut.setPatterns(".*remoteCall.*");

    RetryOperationsInterceptor interceptor = new RetryOperationsInterceptor();

    ((Advised) service).addAdvisor(new DefaultPointcutAdvisor(pointcut, interceptor));

    return service;
}

```

The preceding example uses a default `RetryTemplate` inside the interceptor. To change the policies or listeners, you can inject an instance of `RetryTemplate` into the interceptor.

Chapter 10. Unit Testing

As with other application styles, it is extremely important to unit test any code written as part of a batch job. The Spring core documentation covers how to unit and integration test with Spring in great detail, so it is not repeated here. It is important, however, to think about how to 'end to end' test a batch job, which is what this chapter covers. The `spring-batch-test` project includes classes that facilitate this end-to-end test approach.

10.1. Creating a Unit Test Class

In order for the unit test to run a batch job, the framework must load the job's `ApplicationContext`. Two annotations are used to trigger this behavior:

- `@RunWith(SpringRunner.class)`: Indicates that the class should use Spring's JUnit facilities
- `@ContextConfiguration(...)`: Indicates which resources to configure the `ApplicationContext` with.

Starting from v4.1, it is also possible to inject Spring Batch test utilities like the `JobLauncherTestUtils` and `JobRepositoryTestUtils` in the test context using the `@SpringBatchTest` annotation.

The following example shows the annotations in use:

Using Java Configuration

```
@SpringBatchTest
@RunWith(SpringRunner.class)
@ContextConfiguration(classes=SkipSampleConfiguration.class)
public class SkipSampleFunctionalTests { ... }
```

Using XML Configuration

```
@SpringBatchTest
@RunWith(SpringRunner.class)
@ContextConfiguration(locations = { "/simple-job-launcher-context.xml",
                                   "/jobs/skipSampleJob.xml" })
public class SkipSampleFunctionalTests { ... }
```

10.2. End-To-End Testing of Batch Jobs

'End To End' testing can be defined as testing the complete run of a batch job from beginning to end. This allows for a test that sets up a test condition, executes the job, and verifies the end result.

In the following example, the batch job reads from the database and writes to a flat file. The test method begins by setting up the database with test data. It clears the `CUSTOMER` table and then inserts 10 new records. The test then launches the `Job` by using the `launchJob()` method. The `launchJob()` method is provided by the `JobLauncherTestUtils` class. The `JobLauncherTestUtils` class also provides the `launchJob(JobParameters)` method, which allows the test to give particular parameters. The `launchJob()` method returns the `JobExecution` object, which is useful for asserting

particular information about the **Job** run. In the following case, the test verifies that the **Job** ended with status "COMPLETED":

XML Based Configuration

```
@SpringBatchTest
@RunWith(SpringRunner.class)
@ContextConfiguration(locations = { "/simple-job-launcher-context.xml",
                                   "/jobs/skipSampleJob.xml" })
public class SkipSampleFunctionalTests {

    @Autowired
    private JobLauncherTestUtils jobLauncherTestUtils;

    private SimpleJdbcTemplate simpleJdbcTemplate;

    @Autowired
    public void setDataSource(DataSource dataSource) {
        this.simpleJdbcTemplate = new SimpleJdbcTemplate(dataSource);
    }

    @Test
    public void testJob() throws Exception {
        simpleJdbcTemplate.update("delete from CUSTOMER");
        for (int i = 1; i <= 10; i++) {
            simpleJdbcTemplate.update("insert into CUSTOMER values (?, 0, ?, 100000)",
                                     i, "customer" + i);
        }

        JobExecution jobExecution = jobLauncherTestUtils.launchJob();

        Assert.assertEquals("COMPLETED", jobExecution.getExitStatus().getExitCode());
    }
}
```

```

@SpringBatchTest
@RunWith(SpringRunner.class)
@ContextConfiguration(classes=SkipSampleConfiguration.class)
public class SkipSampleFunctionalTests {

    @Autowired
    private JobLauncherTestUtils jobLauncherTestUtils;

    private SimpleJdbcTemplate simpleJdbcTemplate;

    @Autowired
    public void setDataSource(DataSource dataSource) {
        this.simpleJdbcTemplate = new SimpleJdbcTemplate(dataSource);
    }

    @Test
    public void testJob() throws Exception {
        simpleJdbcTemplate.update("delete from CUSTOMER");
        for (int i = 1; i <= 10; i++) {
            simpleJdbcTemplate.update("insert into CUSTOMER values (?, 0, ?, 100000)",
                i, "customer" + i);
        }

        JobExecution jobExecution = jobLauncherTestUtils.launchJob();

        Assert.assertEquals("COMPLETED", jobExecution.getExitStatus().getExitCode());
    }
}

```

10.3. Testing Individual Steps

For complex batch jobs, test cases in the end-to-end testing approach may become unmanageable. In these cases, it may be more useful to have test cases to test individual steps on their own. The `JobLauncherTestUtils` class contains a method called `launchStep`, which takes a step name and runs just that particular `Step`. This approach allows for more targeted tests letting the test set up data for only that step and to validate its results directly. The following example shows how to use the `launchStep` method to load a `Step` by name:

```
JobExecution jobExecution = jobLauncherTestUtils.launchStep("loadFileStep");
```

10.4. Testing Step-Scoped Components

Often, the components that are configured for your steps at runtime use step scope and late binding to inject context from the step or job execution. These are tricky to test as standalone components,

unless you have a way to set the context as if they were in a step execution. That is the goal of two components in Spring Batch: `StepScopeTestExecutionListener` and `StepScopeTestUtils`.

The listener is declared at the class level, and its job is to create a step execution context for each test method, as shown in the following example:

```
@ContextConfiguration
@TestExecutionListeners( { DependencyInjectionTestExecutionListener.class,
    StepScopeTestExecutionListener.class })
@RunWith(SpringRunner.class)
public class StepScopeTestExecutionListenerIntegrationTests {

    // This component is defined step-scoped, so it cannot be injected unless
    // a step is active...
    @Autowired
    private ItemReader<String> reader;

    public StepExecution getStepExecution() {
        StepExecution execution = MetadataInstanceFactory.createStepExecution();
        execution.getExecutionContext().putString("input.data", "foo,bar,spam");
        return execution;
    }

    @Test
    public void testReader() {
        // The reader is initialized and bound to the input data
        assertNotNull(reader.read());
    }
}
```

There are two `TestExecutionListeners`. One is the regular Spring Test framework, which handles dependency injection from the configured application context to inject the reader. The other is the Spring Batch `StepScopeTestExecutionListener`. It works by looking for a factory method in the test case for a `StepExecution`, using that as the context for the test method, as if that execution were active in a `Step` at runtime. The factory method is detected by its signature (it must return a `StepExecution`). If a factory method is not provided, then a default `StepExecution` is created.

Starting from v4.1, the `StepScopeTestExecutionListener` and `JobScopeTestExecutionListener` are imported as test execution listeners if the test class is annotated with `@SpringBatchTest`. The preceding test example can be configured as follows:

```

@SpringBatchTest
@RunWith(SpringRunner.class)
@ContextConfiguration
public class StepScopeTestExecutionListenerIntegrationTests {

    // This component is defined step-scoped, so it cannot be injected unless
    // a step is active...
    @Autowired
    private ItemReader<String> reader;

    public StepExecution getStepExecution() {
        StepExecution execution = MetadataInstanceFactory.createStepExecution();
        execution.getExecutionContext().putString("input.data", "foo,bar,spam");
        return execution;
    }

    @Test
    public void testReader() {
        // The reader is initialized and bound to the input data
        assertNotNull(reader.read());
    }
}

```

The listener approach is convenient if you want the duration of the step scope to be the execution of the test method. For a more flexible but more invasive approach, you can use the [StepScopeTestUtils](#). The following example counts the number of items available in the reader shown in the previous example:

```

int count = StepScopeTestUtils.doInStepScope(stepExecution,
    new Callable<Integer>() {
        public Integer call() throws Exception {

            int count = 0;

            while (reader.read() != null) {
                count++;
            }
            return count;
        }
    });

```

10.5. Validating Output Files

When a batch job writes to the database, it is easy to query the database to verify that the output is as expected. However, if the batch job writes to a file, it is equally important that the output be verified. Spring Batch provides a class called [AssertFile](#) to facilitate the verification of output files.

The method called `assertFileEquals` takes two `File` objects (or two `Resource` objects) and asserts, line by line, that the two files have the same content. Therefore, it is possible to create a file with the expected output and to compare it to the actual result, as shown in the following example:

```
private static final String EXPECTED_FILE = "src/main/resources/data/input.txt";
private static final String OUTPUT_FILE = "target/test-outputs/output.txt";

AssertFile.assertFileEquals(new FileSystemResource(EXPECTED_FILE),
                             new FileSystemResource(OUTPUT_FILE));
```

10.6. Mocking Domain Objects

Another common issue encountered while writing unit and integration tests for Spring Batch components is how to mock domain objects. A good example is a `StepExecutionListener`, as illustrated in the following code snippet:

```
public class NoWorkFoundStepExecutionListener extends StepExecutionListenerSupport {

    public ExitStatus afterStep(StepExecution stepExecution) {
        if (stepExecution.getReadCount() == 0) {
            return ExitStatus.FAILED;
        }
        return null;
    }
}
```

The preceding listener example is provided by the framework and checks a `StepExecution` for an empty read count, thus signifying that no work was done. While this example is fairly simple, it serves to illustrate the types of problems that may be encountered when attempting to unit test classes that implement interfaces requiring Spring Batch domain objects. Consider the following unit test for the listener's in the preceding example:

```

private NoWorkFoundStepExecutionListener tested = new
NoWorkFoundStepExecutionListener();

@Test
public void noWork() {
    StepExecution stepExecution = new StepExecution("NoProcessingStep",
        new JobExecution(new JobInstance(1L, new JobParameters(),
            "NoProcessingJob")));

    stepExecution.setExitStatus(ExitStatus.COMPLETED);
    stepExecution.setReadCount(0);

    ExitStatus exitStatus = tested.afterStep(stepExecution);
    assertEquals(ExitStatus.FAILED.getExitCode(), exitStatus.getExitCode());
}

```

Because the Spring Batch domain model follows good object-oriented principles, the `StepExecution` requires a `JobExecution`, which requires a `JobInstance` and `JobParameters`, to create a valid `StepExecution`. While this is good in a solid domain model, it does make creating stub objects for unit testing verbose. To address this issue, the Spring Batch test module includes a factory for creating domain objects: `MetaDataInstanceFactory`. Given this factory, the unit test can be updated to be more concise, as shown in the following example:

```

private NoWorkFoundStepExecutionListener tested = new
NoWorkFoundStepExecutionListener();

@Test
public void testAfterStep() {
    StepExecution stepExecution = MetaDataInstanceFactory.createStepExecution();

    stepExecution.setExitStatus(ExitStatus.COMPLETED);
    stepExecution.setReadCount(0);

    ExitStatus exitStatus = tested.afterStep(stepExecution);
    assertEquals(ExitStatus.FAILED.getExitCode(), exitStatus.getExitCode());
}

```

The preceding method for creating a simple `StepExecution` is just one convenience method available within the factory. A full method listing can be found in its [Javadoc](#).

Chapter 11. Common Batch Patterns

Some batch jobs can be assembled purely from off-the-shelf components in Spring Batch. For instance, the `ItemReader` and `ItemWriter` implementations can be configured to cover a wide range of scenarios. However, for the majority of cases, custom code must be written. The main API entry points for application developers are the `Tasklet`, the `ItemReader`, the `ItemWriter`, and the various listener interfaces. Most simple batch jobs can use off-the-shelf input from a Spring Batch `ItemReader`, but it is often the case that there are custom concerns in the processing and writing that require developers to implement an `ItemWriter` or `ItemProcessor`.

In this chapter, we provide a few examples of common patterns in custom business logic. These examples primarily feature the listener interfaces. It should be noted that an `ItemReader` or `ItemWriter` can implement a listener interface as well, if appropriate.

11.1. Logging Item Processing and Failures

A common use case is the need for special handling of errors in a step, item by item, perhaps logging to a special channel or inserting a record into a database. A chunk-oriented `Step` (created from the step factory beans) lets users implement this use case with a simple `ItemReadListener` for errors on `read` and an `ItemWriteListener` for errors on `write`. The following code snippet illustrates a listener that logs both read and write failures:

```
public class ItemFailureLoggerListener extends ItemListenerSupport {

    private static Log logger = LoggerFactory.getLog("item.error");

    public void onReadError(Exception ex) {
        logger.error("Encountered error on read", e);
    }

    public void onWriteError(Exception ex, List<? extends Object> items) {
        logger.error("Encountered error on write", ex);
    }
}
```

Having implemented this listener, it must be registered with a step, as shown in the following example:

```
<step id="simpleStep">
...
<listeners>
  <listener>
    <bean class="org.example...ItemFailureLoggerListener"/>
  </listener>
</listeners>
</step>
```

```
@Bean
public Step simpleStep() {
    return this.stepBuilderFactory.get("simpleStep")
        .listener(new ItemFailureLoggerListener())
        .build();
}
```



if your listener does anything in an `onError()` method, it must be inside a transaction that is going to be rolled back. If you need to use a transactional resource, such as a database, inside an `onError()` method, consider adding a declarative transaction to that method (see Spring Core Reference Guide for details), and giving its propagation attribute a value of `REQUIRES_NEW`.

11.2. Stopping a Job Manually for Business Reasons

Spring Batch provides a `stop()` method through the `JobLauncher` interface, but this is really for use by the operator rather than the application programmer. Sometimes, it is more convenient or makes more sense to stop a job execution from within the business logic.

The simplest thing to do is to throw a `RuntimeException` (one that is neither retried indefinitely nor skipped). For example, a custom exception type could be used, as shown in the following example:

```
public class PoisonPillItemProcessor<T> implements ItemProcessor<T, T> {

    @Override
    public T process(T item) throws Exception {
        if (isPoisonPill(item)) {
            throw new PoisonPillException("Poison pill detected: " + item);
        }
        return item;
    }
}
```

Another simple way to stop a step from executing is to return `null` from the `ItemReader`, as shown in the following example:

```
public class EarlyCompletionItemReader implements ItemReader<T> {

    private ItemReader<T> delegate;

    public void setDelegate(ItemReader<T> delegate) { ... }

    public T read() throws Exception {
        T item = delegate.read();
        if (isEndItem(item)) {
            return null; // end the step here
        }
        return item;
    }
}
```

The previous example actually relies on the fact that there is a default implementation of the `CompletionPolicy` strategy that signals a complete batch when the item to be processed is `null`. A more sophisticated completion policy could be implemented and injected into the `Step` through the `SimpleStepFactoryBean`, as shown in the following example:

XML Configuration

```
<step id="simpleStep">
    <tasklet>
        <chunk reader="reader" writer="writer" commit-interval="10"
            chunk-completion-policy="completionPolicy"/>
    </tasklet>
</step>

<bean id="completionPolicy" class="org.example...SpecialCompletionPolicy"/>
```

Java Configuration

```
@Bean
public Step simpleStep() {
    return this.stepBuilderFactory.get("simpleStep")
        .<String, String>chunk(new SpecialCompletionPolicy())
        .reader(reader())
        .writer(writer())
        .build();
}
```

An alternative is to set a flag in the `StepExecution`, which is checked by the `Step` implementations in the framework in between item processing. To implement this alternative, we need access to the

current `StepExecution`, and this can be achieved by implementing a `StepListener` and registering it with the `Step`. The following example shows a listener that sets the flag:

```
public class CustomItemWriter extends ItemListenerSupport implements StepListener {

    private StepExecution stepExecution;

    public void beforeStep(StepExecution stepExecution) {
        this.stepExecution = stepExecution;
    }

    public void afterRead(Object item) {
        if (isPoisonPill(item)) {
            stepExecution.setTerminateOnly();
        }
    }
}
```

When the flag is set, the default behavior is for the step to throw a `JobInterruptedException`. This behavior can be controlled through the `StepInterruptionPolicy`. However, the only choice is to throw or not throw an exception, so this is always an abnormal ending to a job.

11.3. Adding a Footer Record

Often, when writing to flat files, a "footer" record must be appended to the end of the file, after all processing has been completed. This can be achieved using the `FlatFileFooterCallback` interface provided by Spring Batch. The `FlatFileFooterCallback` (and its counterpart, the `FlatFileHeaderCallback`) are optional properties of the `FlatFileItemWriter` and can be added to an item writer as shown in the following example:

XML Configuration

```
<bean id="itemWriter" class="org.spr...FlatFileItemWriter">
    <property name="resource" ref="outputResource" />
    <property name="lineAggregator" ref="lineAggregator"/>
    <property name="headerCallback" ref="headerCallback" />
    <property name="footerCallback" ref="footerCallback" />
</bean>
```

```
@Bean
public FlatFileItemWriter<String> itemWriter(Resource outputResource) {
    return new FlatFileItemWriterBuilder<String>()
        .name("itemWriter")
        .resource(outputResource)
        .lineAggregator(lineAggregator())
        .headerCallback(headerCallback())
        .footerCallback(footerCallback())
        .build();
}
```

The footer callback interface has just one method that is called when the footer must be written, as shown in the following interface definition:

```
public interface FlatFileFooterCallback {

    void writeFooter(Writer writer) throws IOException;

}
```

11.3.1. Writing a Summary Footer

A common requirement involving footer records is to aggregate information during the output process and to append this information to the end of the file. This footer often serves as a summarization of the file or provides a checksum.

For example, if a batch job is writing **Trade** records to a flat file, and there is a requirement that the total amount from all the **Trades** is placed in a footer, then the following **ItemWriter** implementation can be used:

```

public class TradeItemWriter implements ItemWriter<Trade>,
                                     FlatFileFooterCallback {

    private ItemWriter<Trade> delegate;

    private BigDecimal totalAmount = BigDecimal.ZERO;

    public void write(List<? extends Trade> items) throws Exception {
        BigDecimal chunkTotal = BigDecimal.ZERO;
        for (Trade trade : items) {
            chunkTotal = chunkTotal.add(trade.getAmount());
        }

        delegate.write(items);

        // After successfully writing all items
        totalAmount = totalAmount.add(chunkTotal);
    }

    public void writeFooter(Writer writer) throws IOException {
        writer.write("Total Amount Processed: " + totalAmount);
    }

    public void setDelegate(ItemWriter delegate) {...}
}

```

This `TradeItemWriter` stores a `totalAmount` value that is increased with the `amount` from each `Trade` item written. After the last `Trade` is processed, the framework calls `writeFooter`, which puts the `totalAmount` into the file. Note that the `write` method makes use of a temporary variable, `chunkTotal`, that stores the total of the `Trade` amounts in the chunk. This is done to ensure that, if a skip occurs in the `write` method, the `totalAmount` is left unchanged. It is only at the end of the `write` method, once we are guaranteed that no exceptions are thrown, that we update the `totalAmount`.

In order for the `writeFooter` method to be called, the `TradeItemWriter` (which implements `FlatFileFooterCallback`) must be wired into the `FlatFileItemWriter` as the `footerCallback`. The following example shows how to do so:

XML Configuration

```

<bean id="tradeItemWriter" class="..TradeItemWriter">
    <property name="delegate" ref="flatFileItemWriter" />
</bean>

<bean id="flatFileItemWriter" class="org.spr...FlatFileItemWriter">
    <property name="resource" ref="outputResource" />
    <property name="lineAggregator" ref="lineAggregator"/>
    <property name="footerCallback" ref="tradeItemWriter" />
</bean>

```

```

@Bean
public TradeItemWriter tradeItemWriter() {
    TradeItemWriter itemWriter = new TradeItemWriter();

    itemWriter.setDelegate(flatFileItemWriter(null));

    return itemWriter;
}

@Bean
public FlatFileItemWriter<String> flatFileItemWriter(Resource outputResource) {
    return new FlatFileItemWriterBuilder<String>()
        .name("itemWriter")
        .resource(outputResource)
        .lineAggregator(lineAggregator())
        .footerCallback(tradeItemWriter())
        .build();
}

```

The way that the `TradeItemWriter` has been written so far functions correctly only if the `Step` is not restartable. This is because the class is stateful (since it stores the `totalAmount`), but the `totalAmount` is not persisted to the database. Therefore, it cannot be retrieved in the event of a restart. In order to make this class restartable, the `ItemStream` interface should be implemented along with the methods `open` and `update`, as shown in the following example:

```

public void open(ExecutionContext executionContext) {
    if (executionContext.containsKey("total.amount") {
        totalAmount = (BigDecimal) executionContext.get("total.amount");
    }
}

public void update(ExecutionContext executionContext) {
    executionContext.put("total.amount", totalAmount);
}

```

The `update` method stores the most current version of `totalAmount` to the `ExecutionContext` just before that object is persisted to the database. The `open` method retrieves any existing `totalAmount` from the `ExecutionContext` and uses it as the starting point for processing, allowing the `TradeItemWriter` to pick up on restart where it left off the previous time the `Step` was run.

11.4. Driving Query Based ItemReaders

In the [chapter on readers and writers](#), database input using paging was discussed. Many database vendors, such as DB2, have extremely pessimistic locking strategies that can cause issues if the table being read also needs to be used by other portions of the online application. Furthermore, opening cursors over extremely large datasets can cause issues on databases from certain vendors.

Therefore, many projects prefer to use a 'Driving Query' approach to reading in data. This approach works by iterating over keys, rather than the entire object that needs to be returned, as the following image illustrates:

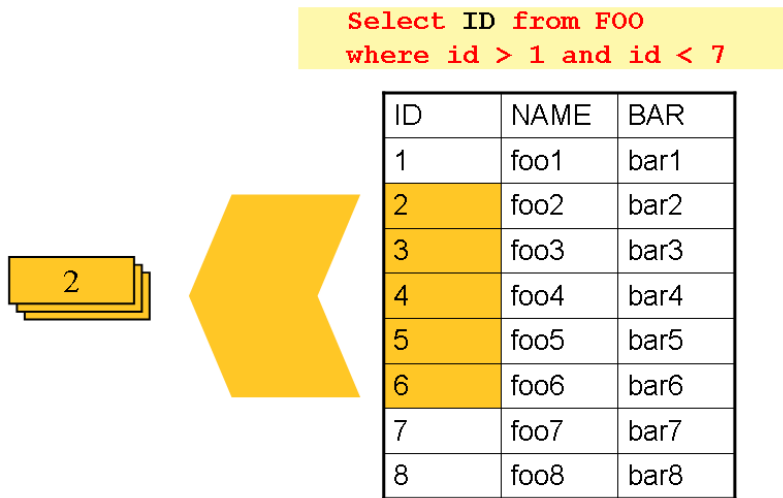

Figure 25. Driving Query Job

As you can see, the example shown in the preceding image uses the same 'FOO' table as was used in the cursor-based example. However, rather than selecting the entire row, only the IDs were selected in the SQL statement. So, rather than a `FOO` object being returned from `read`, an `Integer` is returned. This number can then be used to query for the 'details', which is a complete `Foo` object, as shown in the following image:

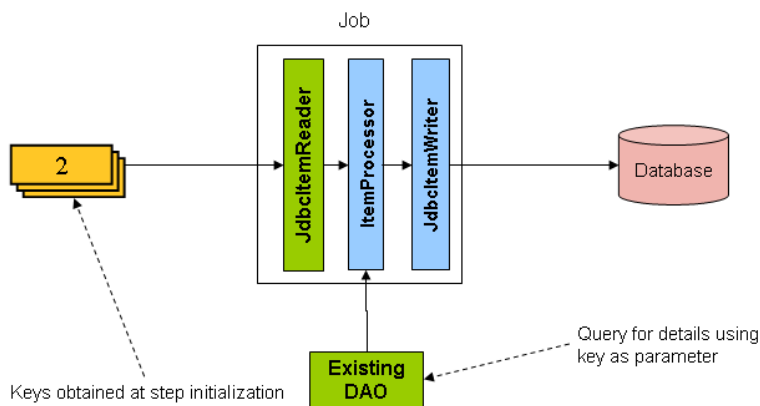

Figure 26. Driving Query Example

An `ItemProcessor` should be used to transform the key obtained from the driving query into a full 'Foo' object. An existing DAO can be used to query for the full object based on the key.

11.5. Multi-Line Records

While it is usually the case with flat files that each record is confined to a single line, it is common that a file might have records spanning multiple lines with multiple formats. The following excerpt

from a file shows an example of such an arrangement:

```
HEA;0013100345;2007-02-15
NCU;Smith;Peter;;;T;20014539;F
BAD;;;Oak Street 31/A;;;Small Town;00235;IL;US
FOT;2;2;267.34
```

Everything between the line starting with 'HEA' and the line starting with 'FOT' is considered one record. There are a few considerations that must be made in order to handle this situation correctly:

- Instead of reading one record at a time, the `ItemReader` must read every line of the multi-line record as a group, so that it can be passed to the `ItemWriter` intact.
- Each line type may need to be tokenized differently.

Because a single record spans multiple lines and because we may not know how many lines there are, the `ItemReader` must be careful to always read an entire record. In order to do this, a custom `ItemReader` should be implemented as a wrapper for the `FlatFileItemReader`, as shown in the following example:

XML Configuration

```
<bean id="itemReader" class="org.spr...MultiLineTradeItemReader">
  <property name="delegate">
    <bean class="org.springframework.batch.item.file.FlatFileItemReader">
      <property name="resource" value="data/iosample/input/multiLine.txt" />
      <property name="lineMapper">
        <bean class="org.spr...DefaultLineMapper">
          <property name="lineTokenizer" ref="orderFileTokenizer"/>
          <property name="fieldSetMapper" ref="orderFieldSetMapper"/>
        </bean>
      </property>
    </bean>
  </property>
</bean>
```

```
@Bean
public MultiLineTradeItemReader itemReader() {
    MultiLineTradeItemReader itemReader = new MultiLineTradeItemReader();

    itemReader.setDelegate(flatFileItemReader());

    return itemReader;
}

@Bean
public FlatFileItemReader flatFileItemReader() {
    FlatFileItemReader<Trade> reader = new FlatFileItemReaderBuilder<>()
        .name("flatFileItemReader")
        .resource(new ClassPathResource("data/iosample/input/multiLine.txt"))
        .lineTokenizer(orderFileTokenizer())
        .fieldSetMapper(orderFieldSetMapper())
        .build();
    return reader;
}
```

To ensure that each line is tokenized properly, which is especially important for fixed-length input, the `PatternMatchingCompositeLineTokenizer` can be used on the delegate `FlatFileItemReader`. See [FlatFileItemReader in the Readers and Writers chapter](#) for more details. The delegate reader then uses a `PassThroughFieldSetMapper` to deliver a `FieldSet` for each line back to the wrapping `ItemReader`, as shown in the following example:

XML Content

```
<bean id="orderFileTokenizer" class="org.spr...PatternMatchingCompositeLineTokenizer">
    <property name="tokenizers">
        <map>
            <entry key="HEA*" value-ref="headerRecordTokenizer" />
            <entry key="FOT*" value-ref="footerRecordTokenizer" />
            <entry key="NCU*" value-ref="customerLineTokenizer" />
            <entry key="BAD*" value-ref="billingAddressLineTokenizer" />
        </map>
    </property>
</bean>
```

```
@Bean
public PatternMatchingCompositelineTokenizer orderFileTokenizer() {
    PatternMatchingCompositelineTokenizer tokenizer =
        new PatternMatchingCompositelineTokenizer();

    Map<String, LineTokenizer> tokenizers = new HashMap<>(4);

    tokenizers.put("HEA*", headerRecordTokenizer());
    tokenizers.put("FOT*", footerRecordTokenizer());
    tokenizers.put("NCU*", customerLineTokenizer());
    tokenizers.put("BAD*", billingAddressLineTokenizer());

    tokenizer.setTokenizers(tokenizers);

    return tokenizer;
}
```

This wrapper has to be able to recognize the end of a record so that it can continually call `read()` on its delegate until the end is reached. For each line that is read, the wrapper should build up the item to be returned. Once the footer is reached, the item can be returned for delivery to the `ItemProcessor` and `ItemWriter`, as shown in the following example:

```

private FlatFileItemReader<FieldSet> delegate;

public Trade read() throws Exception {
    Trade t = null;

    for (FieldSet line = null; (line = this.delegate.read()) != null;) {
        String prefix = line.readString(0);
        if (prefix.equals("HEA")) {
            t = new Trade(); // Record must start with header
        }
        else if (prefix.equals("NCU")) {
            Assert.notNull(t, "No header was found.");
            t.setLast(line.readString(1));
            t.setFirst(line.readString(2));
            ...
        }
        else if (prefix.equals("BAD")) {
            Assert.notNull(t, "No header was found.");
            t.setCity(line.readString(4));
            t.setState(line.readString(6));
            ...
        }
        else if (prefix.equals("FOT")) {
            return t; // Record must end with footer
        }
    }
    Assert.isNull(t, "No 'END' was found.");
    return null;
}

```

11.6. Executing System Commands

Many batch jobs require that an external command be called from within the batch job. Such a process could be kicked off separately by the scheduler, but the advantage of common metadata about the run would be lost. Furthermore, a multi-step job would also need to be split up into multiple jobs as well.

Because the need is so common, Spring Batch provides a `Tasklet` implementation for calling system commands, as shown in the following example:

XML Configuration

```

<bean class="org.springframework.batch.core.step.tasklet.SystemCommandTasklet">
    <property name="command" value="echo hello" />
    <!-- 5 second timeout for the command to complete -->
    <property name="timeout" value="5000" />
</bean>

```

```

@Bean
public SystemCommandTasklet tasklet() {
    SystemCommandTasklet tasklet = new SystemCommandTasklet();

    tasklet.setCommand("echo hello");
    tasklet.setTimeout(5000);

    return tasklet;
}

```

11.7. Handling Step Completion When No Input is Found

In many batch scenarios, finding no rows in a database or file to process is not exceptional. The `Step` is simply considered to have found no work and completes with 0 items read. All of the `ItemReader` implementations provided out of the box in Spring Batch default to this approach. This can lead to some confusion if nothing is written out even when input is present (which usually happens if a file was misnamed or some similar issue arises). For this reason, the metadata itself should be inspected to determine how much work the framework found to be processed. However, what if finding no input is considered exceptional? In this case, programmatically checking the metadata for no items processed and causing failure is the best solution. Because this is a common use case, Spring Batch provides a listener with exactly this functionality, as shown in the class definition for `NoWorkFoundStepExecutionListener`:

```

public class NoWorkFoundStepExecutionListener extends StepExecutionListenerSupport {

    public ExitStatus afterStep(StepExecution stepExecution) {
        if (stepExecution.getReadCount() == 0) {
            return ExitStatus.FAILED;
        }
        return null;
    }
}

```

The preceding `StepExecutionListener` inspects the `readCount` property of the `StepExecution` during the 'afterStep' phase to determine if no items were read. If that is the case, an exit code of `FAILED` is returned, indicating that the `Step` should fail. Otherwise, `null` is returned, which does not affect the status of the `Step`.

11.8. Passing Data to Future Steps

It is often useful to pass information from one step to another. This can be done through the `ExecutionContext`. The catch is that there are two `ExecutionContexts`: one at the `Step` level and one at

the **Job** level. The **Step ExecutionContext** remains only as long as the step, while the **Job ExecutionContext** remains through the whole **Job**. On the other hand, the **Step ExecutionContext** is updated every time the **Step** commits a chunk, while the **Job ExecutionContext** is updated only at the end of each **Step**.

The consequence of this separation is that all data must be placed in the **Step ExecutionContext** while the **Step** is executing. Doing so ensures that the data is stored properly while the **Step** runs. If data is stored to the **Job ExecutionContext**, then it is not persisted during **Step** execution. If the **Step** fails, that data is lost.

```
public class SavingItemWriter implements ItemWriter<Object> {
    private StepExecution stepExecution;

    public void write(List<? extends Object> items) throws Exception {
        // ...

        ExecutionContext stepContext = this.stepExecution.getExecutionContext();
        stepContext.put("someKey", someObject);
    }

    @BeforeStep
    public void saveStepExecution(StepExecution stepExecution) {
        this.stepExecution = stepExecution;
    }
}
```

To make the data available to future **Steps**, it must be "promoted" to the **Job ExecutionContext** after the step has finished. Spring Batch provides the **ExecutionContextPromotionListener** for this purpose. The listener must be configured with the keys related to the data in the **ExecutionContext** that must be promoted. It can also, optionally, be configured with a list of exit code patterns for which the promotion should occur (**COMPLETED** is the default). As with all listeners, it must be registered on the **Step** as shown in the following example:

```
<job id="job1">
  <step id="step1">
    <tasklet>
      <chunk reader="reader" writer="savingWriter" commit-interval="10"/>
    </tasklet>
    <listeners>
      <listener ref="promotionListener"/>
    </listeners>
  </step>

  <step id="step2">
    ...
  </step>
</job>

<beans:bean id="promotionListener" class="
org.spr....ExecutionContextPromotionListener">
  <beans:property name="keys">
    <list>
      <value>someKey</value>
    </list>
  </beans:property>
</beans:bean>
```



```

@Bean
public Job job1() {
    return this.jobBuilderFactory.get("job1")
        .start(step1())
        .next(step1())
        .build();
}

@Bean
public Step step1() {
    return this.stepBuilderFactory.get("step1")
        .<String, String>chunk(10)
        .reader(reader())
        .writer(savingWriter())
        .listener(promotionListener())
        .build();
}

@Bean
public ExecutionContextPromotionListener promotionListener() {
    ExecutionContextPromotionListener listener = new
ExecutionContextPromotionListener();

    listener.setKeys(new String[] {"someKey" });

    return listener;
}

```

Finally, the saved values must be retrieved from the `Job ExecutionContext`, as shown in the following example:

```

public class RetrievingItemWriter implements ItemWriter<Object> {
    private Object someObject;

    public void write(List<? extends Object> items) throws Exception {
        // ...
    }

    @BeforeStep
    public void retrieveInterstepData(StepExecution stepExecution) {
        JobExecution jobExecution = stepExecution.getJobExecution();
        ExecutionContext jobContext = jobExecution.getExecutionContext();
        this.someObject = jobContext.get("someKey");
    }
}

```

Chapter 12. JSR-352 Support

As of Spring Batch 3.0 support for JSR-352 has been fully implemented. This section is not a replacement for the spec itself and instead, intends to explain how the JSR-352 specific concepts apply to Spring Batch. Additional information on JSR-352 can be found via the JCP here: <https://jcp.org/en/jsr/detail?id=352>

12.1. General Notes about Spring Batch and JSR-352

Spring Batch and JSR-352 are structurally the same. They both have jobs that are made up of steps. They both have readers, processors, writers, and listeners. However, their interactions are subtly different. For example, the `org.springframework.batch.core.Skiplistener#onSkipInWrite(S item, Throwable t)` within Spring Batch receives two parameters: the item that was skipped and the Exception that caused the skip. The JSR-352 version of the same method (`javax.batch.api.chunk.listener.SkipWriteListener#onSkipWriteItem(List<Object> items, Exception ex)`) also receives two parameters. However the first one is a `List` of all the items within the current chunk with the second being the `Exception` that caused the skip. Because of these differences, it is important to note that there are two paths to execute a job within Spring Batch: either a traditional Spring Batch job or a JSR-352 based job. While the use of Spring Batch artifacts (readers, writers, etc) will work within a job configured via JSR-352's JSL and executed via the `JsrJobOperator`, they will behave according to the rules of JSR-352. It is also important to note that batch artifacts that have been developed against the JSR-352 interfaces will not work within a traditional Spring Batch job.

12.2. Setup

12.2.1. Application Contexts

All JSR-352 based jobs within Spring Batch consist of two application contexts. A parent context, that contains beans related to the infrastructure of Spring Batch such as the `JobRepository`, `PlatformTransactionManager`, etc and a child context that consists of the configuration of the job to be run. The parent context is defined via the `jsrBaseContext.xml` provided by the framework. This context may be overridden via the `JSR-352-BASE-CONTEXT` system property.



The base context is not processed by the JSR-352 processors for things like property injection so no components requiring that additional processing should be configured there.

12.2.2. Launching a JSR-352 based job

JSR-352 requires a very simple path to executing a batch job. The following code is all that is needed to execute your first batch job:

```
JobOperator operator = BatchRuntime.getJobOperator();
jobOperator.start("myJob", new Properties());
```

While that is convenient for developers, the devil is in the details. Spring Batch bootstraps a bit of infrastructure behind the scenes that a developer may want to override. The following is bootstrapped the first time `BatchRuntime.getJobOperator()` is called:

<i>Bean Name</i>	<i>Default Configuration</i>	<i>Notes</i>
dataSource	Apache DBCP BasicDataSource with configured values.	By default, HSQLDB is bootstrapped.
transactionManager	<code>org.springframework.jdbc.datasource.DataSourceTransactionManager</code>	References the dataSource bean defined above.
A Datasource initializer		This is configured to execute the scripts configured via the <code>batch.drop.script</code> and <code>batch.schema.script</code> properties. By default, the schema scripts for HSQLDB are executed. This behavior can be disabled via <code>batch.data.source.init</code> property.
jobRepository	A JDBC based <code>SimpleJobRepository</code> .	This <code>JobRepository</code> uses the previously mentioned data source and transaction manager. The schema's table prefix is configurable (defaults to BATCH_) via the <code>batch.table.prefix</code> property.
jobLauncher	<code>org.springframework.batch.core.launch.support.SimpleJobLauncher</code>	Used to launch jobs.
batchJobOperator	<code>org.springframework.batch.core.launch.support.SimpleJobOperator</code>	The <code>JsrJobOperator</code> wraps this to provide most of it's functionality.
jobExplorer	<code>org.springframework.batch.core.explore.support.JobExplorerFactoryBean</code>	Used to address lookup functionality provided by the <code>JsrJobOperator</code> .
jobParametersConverter	<code>org.springframework.batch.core.jsr.JsrJobParametersConverter</code>	JSR-352 specific implementation of the <code>JobParametersConverter</code> .
jobRegistry	<code>org.springframework.batch.core.configuration.support.MapJobRegistry</code>	Used by the <code>SimpleJobOperator</code> .
placeholderProperties	<code>org.springframework.beans.factory.config.PropertyPlaceholderConfigure</code>	Loads the properties file <code>batch-\${ENVIRONMENT:hsqldb}.properties</code> to configure the properties mentioned above. ENVIRONMENT is a System property (defaults to hsqldb) that can be used to specify any of the supported databases Spring Batch currently supports.



None of the above beans are optional for executing JSR-352 based jobs. All may be overridden to provide customized functionality as needed.

12.3. Dependency Injection

JSR-352 is based heavily on the Spring Batch programming model. As such, while not explicitly requiring a formal dependency injection implementation, DI of some kind implied. Spring Batch supports all three methods for loading batch artifacts defined by JSR-352:

- Implementation Specific Loader - Spring Batch is built upon Spring and so supports Spring dependency injection within JSR-352 batch jobs.
- Archive Loader - JSR-352 defines the existing of a batch.xml file that provides mappings between a logical name and a class name. This file must be found within the /META-INF/ directory if it is used.
- Thread Context Class Loader - JSR-352 allows configurations to specify batch artifact implementations in their JSL by providing the fully qualified class name inline. Spring Batch supports this as well in JSR-352 configured jobs.

To use Spring dependency injection within a JSR-352 based batch job consists of configuring batch artifacts using a Spring application context as beans. Once the beans have been defined, a job can refer to them as it would any bean defined within the batch.xml.

XML Configuration

```
<?xml version="1.0" encoding="UTF-8"?>
<beans xmlns="http://www.springframework.org/schema/beans"
       xmlns:xsi="http://www.w3.org/2001/XMLSchema-instance"
       xsi:schemaLocation="http://www.springframework.org/schema/beans
                           https://www.springframework.org/schema/beans/spring-
beans.xsd
                           http://xmlns.jcp.org/xml/ns/javaee
                           https://xmlns.jcp.org/xml/ns/javaee/jobXML_1_0.xsd">

  <!-- javax.batch.api.Batchlet implementation -->
  <bean id="fooBatchlet" class="io.spring.FooBatchlet">
    <property name="prop" value="bar"/>
  </bean>

  <!-- Job is defined using the JSL schema provided in JSR-352 -->
  <job id="fooJob" xmlns="http://xmlns.jcp.org/xml/ns/javaee" version="1.0">
    <step id="step1">
      <batchlet ref="fooBatchlet"/>
    </step>
  </job>
</beans>
```

```

@Configuration
public class BatchConfiguration {

    @Bean
    public Batchlet fooBatchlet() {
        FooBatchlet batchlet = new FooBatchlet();
        batchlet.setProp("bar");
        return batchlet;
    }
}

<?xml version="1.0" encoding="UTF-8"?>
<job id="fooJob" xmlns="http://xmlns.jcp.org/xml/ns/javaee" version="1.0">
  <step id="step1" >
    <batchlet ref="fooBatchlet" />
  </step>
</job>

```

The assembly of Spring contexts (imports, etc) works with JSR-352 jobs just as it would with any other Spring based application. The only difference with a JSR-352 based job is that the entry point for the context definition will be the job definition found in /META-INF/batch-jobs/.

To use the thread context class loader approach, all you need to do is provide the fully qualified class name as the ref. It is important to note that when using this approach or the batch.xml approach, the class referenced requires a no argument constructor which will be used to create the bean.

```

<?xml version="1.0" encoding="UTF-8"?>
<job id="fooJob" xmlns="http://xmlns.jcp.org/xml/ns/javaee" version="1.0">
  <step id="step1" >
    <batchlet ref="io.spring.FooBatchlet" />
  </step>
</job>

```

12.4. Batch Properties

12.4.1. Property Support

JSR-352 allows for properties to be defined at the Job, Step and batch artifact level by way of configuration in the JSL. Batch properties are configured at each level in the following way:

```
<properties>
  <property name="propertyName1" value="propertyValue1"/>
  <property name="propertyName2" value="propertyValue2"/>
</properties>
```

`Properties` may be configured on any batch artifact.

12.4.2. @BatchProperty annotation

`Properties` are referenced in batch artifacts by annotating class fields with the `@BatchProperty` and `@Inject` annotations (both annotations are required by the spec). As defined by JSR-352, fields for properties must be String typed. Any type conversion is up to the implementing developer to perform.

An `javax.batch.api.chunk.ItemReader` artifact could be configured with a properties block such as the one described above and accessed as such:

```
public class MyItemReader extends AbstractItemReader {
    @Inject
    @BatchProperty
    private String propertyName1;

    ...
}
```

The value of the field "propertyName1" will be "propertyValue1"

12.4.3. Property Substitution

Property substitution is provided by way of operators and simple conditional expressions. The general usage is `#{operator['key']}`.

Supported operators:

- `jobParameters` - access job parameter values that the job was started/restarted with.
- `jobProperties` - access properties configured at the job level of the JSL.
- `systemProperties` - access named system properties.
- `partitionPlan` - access named property from the partition plan of a partitioned step.

```
#{jobParameters['unresolving.prop']}?:#{systemProperties['file.separator']}
```

The left hand side of the assignment is the expected value, the right hand side is the default value. In this example, the result will resolve to a value of the system property `file.separator` as `#{jobParameters['unresolving.prop']}` is assumed to not be resolvable. If neither expressions can be resolved, an empty String will be returned. Multiple conditions can be used, which are separated by

a';.

12.5. Processing Models

JSR-352 provides the same two basic processing models that Spring Batch does:

- Item based processing - Using an `javax.batch.api.chunk.ItemReader`, an optional `javax.batch.api.chunk.ItemProcessor`, and an `javax.batch.api.chunk.ItemWriter`.
- Task based processing - Using a `javax.batch.api.Batchlet` implementation. This processing model is the same as the `org.springframework.batch.core.step.tasklet.Tasklet` based processing currently available.

12.5.1. Item based processing

Item based processing in this context is a chunk size being set by the number of items read by an `ItemReader`. To configure a step this way, specify the `item-count` (which defaults to 10) and optionally configure the `checkpoint-policy` as item (this is the default).

```
...
<step id="step1">
  <chunk checkpoint-policy="item" item-count="3">
    <reader ref="fooReader"/>
    <processor ref="fooProcessor"/>
    <writer ref="fooWriter"/>
  </chunk>
</step>
...
```

If item based checkpointing is chosen, an additional attribute `time-limit` is supported. This sets a time limit for how long the number of items specified has to be processed. If the timeout is reached, the chunk will complete with however many items have been read by then regardless of what the `item-count` is configured to be.

12.5.2. Custom checkpointing

JSR-352 calls the process around the commit interval within a step "checkpointing". Item based checkpointing is one approach as mentioned above. However, this will not be robust enough in many cases. Because of this, the spec allows for the implementation of a custom checkpointing algorithm by implementing the `javax.batch.api.chunk.CheckpointAlgorithm` interface. This functionality is functionally the same as Spring Batch's custom completion policy. To use an implementation of `CheckpointAlgorithm`, configure your step with the custom `checkpoint-policy` as shown below where `fooCheckpointier` refers to an implementation of `CheckpointAlgorithm`.

```

...
<step id="step1">
  <chunk checkpoint-policy="custom">
    <checkpoint-algorithm ref="fooCheckpointer"/>
    <reader ref="fooReader"/>
    <processor ref="fooProcessor"/>
    <writer ref="fooWriter"/>
  </chunk>
</step>
...

```

12.6. Running a job

The entrance to executing a JSR-352 based job is through the `javax.batch.operations.JobOperator`. Spring Batch provides its own implementation of this interface (`org.springframework.batch.core.jsr.launch.JsrJobOperator`). This implementation is loaded via the `javax.batch.runtime.BatchRuntime`. Launching a JSR-352 based batch job is implemented as follows:

```

JobOperator jobOperator = BatchRuntime.getJobOperator();
long jobExecutionId = jobOperator.start("fooJob", new Properties());

```

The above code does the following:

- Bootstraps a base `ApplicationContext` - In order to provide batch functionality, the framework needs some infrastructure bootstrapped. This occurs once per JVM. The components that are bootstrapped are similar to those provided by `@EnableBatchProcessing`. Specific details can be found in the javadoc for the `JsrJobOperator`.
- Loads an `ApplicationContext` for the job requested - In the example above, the framework will look in `/META-INF/batch-jobs` for a file named `fooJob.xml` and load a context that is a child of the shared context mentioned previously.
- Launch the job - The job defined within the context will be executed asynchronously. The `JobExecution`'s id will be returned.



All JSR-352 based batch jobs are executed asynchronously.

When `JobOperator#start` is called using `SimpleJobOperator`, Spring Batch determines if the call is an initial run or a retry of a previously executed run. Using the JSR-352 based `JobOperator#start(String jobXMLName, Properties jobParameters)`, the framework will always create a new `JobInstance` (JSR-352 job parameters are non-identifying). In order to restart a job, a call to `JobOperator#restart(long executionId, Properties restartParameters)` is required.

12.7. Contexts

JSR-352 defines two context objects that are used to interact with the meta-data of a job or step from within a batch artifact: `javax.batch.runtime.context.JobContext` and

`javax.batch.runtime.context.StepContext`. Both of these are available in any step level artifact (`Batchlet`, `ItemReader`, etc) with the `JobContext` being available to job level artifacts as well (`JobListener` for example).

To obtain a reference to the `JobContext` or `StepContext` within the current scope, simply use the `@Inject` annotation:

```
@Inject
JobContext jobContext;
```



@Autowire for JSR-352 contexts

Using Spring's `@Autowire` is not supported for the injection of these contexts.

In Spring Batch, the `JobContext` and `StepContext` wrap their corresponding execution objects (`JobExecution` and `StepExecution` respectively). Data stored via `StepContext#setPersistentUserData(Serializable data)` is stored in the Spring Batch `StepExecution#executionContext`.

12.8. Step Flow

Within a JSR-352 based job, the flow of steps works similarly as it does within Spring Batch. However, there are a few subtle differences:

- Decision's are steps - In a regular Spring Batch job, a decision is a state that does not have an independent `StepExecution` or any of the rights and responsibilities that go along with being a full step.. However, with JSR-352, a decision is a step just like any other and will behave just as any other steps (transactionality, it gets a `StepExecution`, etc). This means that they are treated the same as any other step on restarts as well.
- `next` attribute and step transitions - In a regular job, these are allowed to appear together in the same step. JSR-352 allows them to both be used in the same step with the `next` attribute taking precedence in evaluation.
- Transition element ordering - In a standard Spring Batch job, transition elements are sorted from most specific to least specific and evaluated in that order. JSR-352 jobs evaluate transition elements in the order they are specified in the XML.

12.9. Scaling a JSR-352 batch job

Traditional Spring Batch jobs have four ways of scaling (the last two capable of being executed across multiple JVMs):

- Split - Running multiple steps in parallel.
- Multiple threads - Executing a single step via multiple threads.
- Partitioning - Dividing the data up for parallel processing (manager/worker).
- Remote Chunking - Executing the processor piece of logic remotely.

JSR-352 provides two options for scaling batch jobs. Both options support only a single JVM:

- Split - Same as Spring Batch
- Partitioning - Conceptually the same as Spring Batch however implemented slightly different.

12.9.1. Partitioning

Conceptually, partitioning in JSR-352 is the same as it is in Spring Batch. Meta-data is provided to each worker to identify the input to be processed, with the workers reporting back to the manager the results upon completion. However, there are some important differences:

- **Partitioned Batchlet** - This will run multiple instances of the configured **Batchlet** on multiple threads. Each instance will have it's own set of properties as provided by the JSL or the **PartitionPlan**
- **PartitionPlan** - With Spring Batch's partitioning, an **ExecutionContext** is provided for each partition. With JSR-352, a single **javax.batch.api.partition.PartitionPlan** is provided with an array of **Properties** providing the meta-data for each partition.
- **PartitionMapper** - JSR-352 provides two ways to generate partition meta-data. One is via the JSL (partition properties). The second is via an implementation of the **javax.batch.api.partition.PartitionMapper** interface. Functionally, this interface is similar to the **org.springframework.batch.core.partition.support.Partitioner** interface provided by Spring Batch in that it provides a way to programmatically generate meta-data for partitioning.
- **StepExecutions** - In Spring Batch, partitioned steps are run as manager/worker. Within JSR-352, the same configuration occurs. However, the worker steps do not get official **StepExecutions**. Because of that, calls to **JsrJobOperator#getStepExecutions(long jobExecutionId)** will only return the **StepExecution** for the manager.



The child **StepExecutions** still exist in the job repository and are available via the **JobExplorer** and Spring Batch Admin.

- **Compensating logic** - Since Spring Batch implements the manager/worker logic of partitioning using steps, **StepExecutionListeners** can be used to handle compensating logic if something goes wrong. However, since the workers JSR-352 provides a collection of other components for the ability to provide compensating logic when errors occur and to dynamically set the exit status. These components include the following:

<i>Artifact Interface</i>	<i>Description</i>
javax.batch.api.partition.PartitionCollector	Provides a way for worker steps to send information back to the manager. There is one instance per worker thread.
javax.batch.api.partition.PartitionAnalyzer	End point that receives the information collected by the PartitionCollector as well as the resulting statuses from a completed partition.
javax.batch.api.partition.PartitionReducer	Provides the ability to provide compensating logic for a partitioned step.

12.10. Testing

Since all JSR-352 based jobs are executed asynchronously, it can be difficult to determine when a job has completed. To help with testing, Spring Batch provides the `org.springframework.batch.test.JsrTestUtils`. This utility class provides the ability to start a job and restart a job and wait for it to complete. Once the job completes, the associated `JobExecution` is returned.

Chapter 13. Spring Batch Integration

13.1. Spring Batch Integration Introduction

Many users of Spring Batch may encounter requirements that are outside the scope of Spring Batch but that may be efficiently and concisely implemented by using Spring Integration. Conversely, Spring Integration users may encounter Spring Batch requirements and need a way to efficiently integrate both frameworks. In this context, several patterns and use-cases emerge, and Spring Batch Integration addresses those requirements.

The line between Spring Batch and Spring Integration is not always clear, but two pieces of advice can help: Think about granularity, and apply common patterns. Some of those common patterns are described in this reference manual section.

Adding messaging to a batch process enables automation of operations and also separation and strategizing of key concerns. For example, a message might trigger a job to execute, and then the sending of the message can be exposed in a variety of ways. Alternatively, when a job completes or fails, that event might trigger a message to be sent, and the consumers of those messages might have operational concerns that have nothing to do with the application itself. Messaging can also be embedded in a job (for example reading or writing items for processing via channels). Remote partitioning and remote chunking provide methods to distribute workloads over a number of workers.

This section covers the following key concepts:

- [Namespace Support](#)
- [Launching Batch Jobs through Messages](#)
- [Providing Feedback with Informational Messages](#)
- [Asynchronous Processors](#)
- [Externalizing Batch Process Execution](#)

13.1.1. Namespace Support

Since Spring Batch Integration 1.3, dedicated XML Namespace support was added, with the aim to provide an easier configuration experience. In order to activate the namespace, add the following namespace declarations to your Spring XML Application Context file:

```

<beans xmlns="http://www.springframework.org/schema/beans"
  xmlns:xsi="http://www.w3.org/2001/XMLSchema-instance"
  xmlns:batch-int="http://www.springframework.org/schema/batch-integration"
  xsi:schemaLocation="
    http://www.springframework.org/schema/batch-integration
    https://www.springframework.org/schema/batch-integration/spring-batch-
integration.xsd">
  ...
</beans>

```

A fully configured Spring XML Application Context file for Spring Batch Integration may look like the following:

```

<beans xmlns="http://www.springframework.org/schema/beans"
  xmlns:xsi="http://www.w3.org/2001/XMLSchema-instance"
  xmlns:int="http://www.springframework.org/schema/integration"
  xmlns:batch="http://www.springframework.org/schema/batch"
  xmlns:batch-int="http://www.springframework.org/schema/batch-integration"
  xsi:schemaLocation="
    http://www.springframework.org/schema/batch-integration
    https://www.springframework.org/schema/batch-integration/spring-batch-
integration.xsd
    http://www.springframework.org/schema/batch
    https://www.springframework.org/schema/batch/spring-batch.xsd
    http://www.springframework.org/schema/beans
    https://www.springframework.org/schema/beans/spring-beans.xsd
    http://www.springframework.org/schema/integration
    https://www.springframework.org/schema/integration/spring-integration.xsd">
  ...
</beans>

```

Appending version numbers to the referenced XSD file is also allowed, but, as a version-less declaration always uses the latest schema, we generally do not recommend appending the version number to the XSD name. Adding a version number could possibly create issues when updating the Spring Batch Integration dependencies, as they may require more recent versions of the XML schema.

13.1.2. Launching Batch Jobs through Messages

When starting batch jobs by using the core Spring Batch API, you basically have 2 options:

- From the command line, with the `CommandLineJobRunner`
- Programmatically, with either `JobOperator.start()` or `JobLauncher.run()`

For example, you may want to use the `CommandLineJobRunner` when invoking Batch Jobs by using a shell script. Alternatively, you may use the `JobOperator` directly (for example, when using Spring Batch as part of a web application). However, what about more complex use cases? Maybe you need to poll a remote (S)FTP server to retrieve the data for the Batch Job or your application has to support multiple different data sources simultaneously. For example, you may receive data files not only from the web, but also from FTP and other sources. Maybe additional transformation of the input files is needed before invoking Spring Batch.

Therefore, it would be much more powerful to execute the batch job using Spring Integration and its numerous adapters. For example, you can use a `File Inbound Channel Adapter` to monitor a directory in the file-system and start the Batch Job as soon as the input file arrives. Additionally, you can create Spring Integration flows that use multiple different adapters to easily ingest data for your batch jobs from multiple sources simultaneously using only configuration. Implementing all these scenarios with Spring Integration is easy, as it allows for decoupled, event-driven execution of the `JobLauncher`.

Spring Batch Integration provides the `JobLaunchingMessageHandler` class that you can use to launch batch jobs. The input for the `JobLaunchingMessageHandler` is provided by a Spring Integration message, which has a payload of type `JobLaunchRequest`. This class is a wrapper around the `Job` that needs to be launched and around the `JobParameters` necessary to launch the Batch job.

The following image illustrates the typical Spring Integration message flow in order to start a Batch job. The [EIP \(Enterprise Integration Patterns\) website](#) provides a full overview of messaging icons and their descriptions.

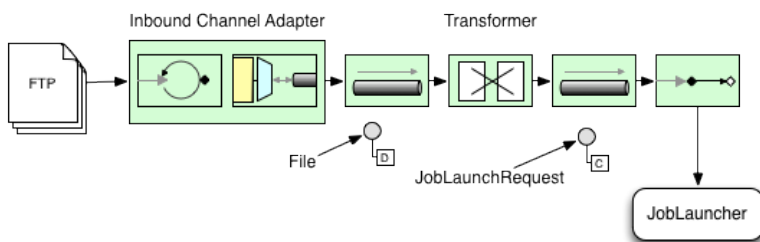

Figure 27. Launch Batch Job

Transforming a file into a `JobLaunchRequest`

```

package io.spring.sbi;

import org.springframework.batch.core.Job;
import org.springframework.batch.core.JobParametersBuilder;
import org.springframework.batch.integration.launch.JobLaunchRequest;
import org.springframework.integration.annotation.Transformer;
import org.springframework.messaging.Message;

import java.io.File;

public class FileMessageToJobRequest {
    private Job job;
    private String fileParameterName;

    public void setFileParameterName(String fileParameterName) {
        this.fileParameterName = fileParameterName;
    }

    public void setJob(Job job) {
        this.job = job;
    }

    @Transformer
    public JobLaunchRequest toRequest(Message<File> message) {
        JobParametersBuilder jobParametersBuilder =
            new JobParametersBuilder();

        jobParametersBuilder.addString(fileParameterName,
            message.getPayload().getAbsolutePath());

        return new JobLaunchRequest(job, jobParametersBuilder.toJobParameters());
    }
}

```

The JobExecution Response

When a batch job is being executed, a `JobExecution` instance is returned. This instance can be used to determine the status of an execution. If a `JobExecution` is able to be created successfully, it is always returned, regardless of whether or not the actual execution is successful.

The exact behavior on how the `JobExecution` instance is returned depends on the provided `TaskExecutor`. If a `synchronous` (single-threaded) `TaskExecutor` implementation is used, the `JobExecution` response is returned only *after* the job completes. When using an `asynchronous` `TaskExecutor`, the `JobExecution` instance is returned immediately. Users can then take the `id` of `JobExecution` instance (with `JobExecution.getJobId()`) and query the `JobRepository` for the job's updated status using the `JobExplorer`. For more information, please refer to the Spring Batch reference documentation on [Querying the Repository](#).

Spring Batch Integration Configuration

The following configuration creates a file `inbound-channel-adapter` to listen for CSV files in the provided directory, hand them off to our transformer (`FileMessageToJobRequest`), launch the job via the *Job Launching Gateway*, and then log the output of the `JobExecution` with the `logging-channel-adapter`.

XML Configuration

```
<int:channel id="inboundFileChannel"/>
<int:channel id="outboundJobRequestChannel"/>
<int:channel id="jobLaunchReplyChannel"/>

<int-file:inbound-channel-adapter id="filePoller"
  channel="inboundFileChannel"
  directory="file:/tmp/myfiles/"
  filename-pattern="*.csv">
  <int:poller fixed-rate="1000"/>
</int-file:inbound-channel-adapter>

<int:transformer input-channel="inboundFileChannel"
  output-channel="outboundJobRequestChannel">
  <bean class="io.spring.sbi.FileMessageToJobRequest">
    <property name="job" ref="personJob"/>
    <property name="fileParameterName" value="input.file.name"/>
  </bean>
</int:transformer>

<batch-int:job-launching-gateway request-channel="outboundJobRequestChannel"
  reply-channel="jobLaunchReplyChannel"/>

<int:logging-channel-adapter channel="jobLaunchReplyChannel"/>
```



```
@Bean
public FileMessageToJobRequest fileMessageToJobRequest() {
    FileMessageToJobRequest fileMessageToJobRequest = new FileMessageToJobRequest();
    fileMessageToJobRequest.setFileParameterName("input.file.name");
    fileMessageToJobRequest.setJob(personJob());
    return fileMessageToJobRequest;
}

@Bean
public JobLaunchingGateway jobLaunchingGateway() {
    SimpleJobLauncher simpleJobLauncher = new SimpleJobLauncher();
    simpleJobLauncher.setJobRepository(jobRepository);
    simpleJobLauncher.setTaskExecutor(new SyncTaskExecutor());
    JobLaunchingGateway jobLaunchingGateway = new JobLaunchingGateway
(simpleJobLauncher);

    return jobLaunchingGateway;
}

@Bean
public IntegrationFlow integrationFlow(JobLaunchingGateway jobLaunchingGateway) {
    return IntegrationFlows.from(Files.inboundAdapter(new File("/tmp/myfiles")).
        filter(new SimplePatternFileListFilter("*.csv")),
        c -> c.poller(Pollers.fixedRate(1000).maxMessagesPerPoll(1))).
        transform(fileMessageToJobRequest()).
        handle(jobLaunchingGateway).
        log(LoggingHandler.Level.WARN, "headers.id + ': ' + payload").
        get();
}
```

Example ItemReader Configuration

Now that we are polling for files and launching jobs, we need to configure our Spring Batch **ItemReader** (for example) to use the files found at the location defined by the job parameter called "input.file.name", as shown in the following bean configuration:

XML Configuration

```
<bean id="itemReader" class="org.springframework.batch.item.file.FlatFileItemReader"
    scope="step">
    <property name="resource" value="file://#{jobParameters['input.file.name']}" />
    ...
</bean>
```

```

@Bean
@StepScope
public ItemReader sampleReader(@Value("#{jobParameters[input.file.name]}") String
resource) {
    ...
    FlatFileItemReader flatFileItemReader = new FlatFileItemReader();
    flatFileItemReader.setResource(new FileSystemResource(resource));
    ...
    return flatFileItemReader;
}

```

The main points of interest in the preceding example are injecting the value of `#{jobParameters['input.file.name']}` as the Resource property value and setting the `ItemReader` bean to have *Step scope*. Setting the bean to have Step scope takes advantage of the late binding support, which allows access to the `jobParameters` variable.

13.2. Available Attributes of the Job-Launching Gateway

The job-launching gateway has the following attributes that you can set to control a job:

- **id**: Identifies the underlying Spring bean definition, which is an instance of either:
 - `EventDrivenConsumer`
 - `PollingConsumer` (The exact implementation depends on whether the component's input channel is a `SubscribableChannel` or `PollableChannel`.)
- **auto-startup**: Boolean flag to indicate that the endpoint should start automatically on startup. The default is *true*.
- **request-channel**: The input `MessageChannel` of this endpoint.
- **reply-channel**: `MessageChannel` to which the resulting `JobExecution` payload is sent.
- **reply-timeout**: Lets you specify how long (in milliseconds) this gateway waits for the reply message to be sent successfully to the reply channel before throwing an exception. This attribute only applies when the channel might block (for example, when using a bounded queue channel that is currently full). Also, keep in mind that, when sending to a `DirectChannel`, the invocation occurs in the sender's thread. Therefore, the failing of the send operation may be caused by other components further downstream. The `reply-timeout` attribute maps to the `sendTimeout` property of the underlying `MessagingTemplate` instance. If not specified, the attribute defaults to `-1`, meaning that, by default, the `Gateway` waits indefinitely.
- **job-launcher**: Optional. Accepts a custom `JobLauncher` bean reference. If not specified the adapter re-uses the instance that is registered under the `id` of `jobLauncher`. If no default instance exists, an exception is thrown.
- **order**: Specifies the order of invocation when this endpoint is connected as a subscriber to a `SubscribableChannel`.

13.3. Sub-Elements

When this `Gateway` is receiving messages from a `PollableChannel`, you must either provide a global default `Poller` or provide a `Poller` sub-element to the `Job Launching Gateway`, as shown in the following example:

XML Configuration

```
<batch-int:job-launching-gateway request-channel="queueChannel"
  reply-channel="replyChannel" job-launcher="jobLauncher">
  <int:poller fixed-rate="1000">
</batch-int:job-launching-gateway>
```

Java Configuration

```
@Bean
@ServiceActivator(inputChannel = "queueChannel", poller = @Poller(fixedRate="1000"))
public JobLaunchingGateway sampleJobLaunchingGateway() {
    JobLaunchingGateway jobLaunchingGateway = new JobLaunchingGateway(jobLauncher());
    jobLaunchingGateway.setOutputChannel(replyChannel());
    return jobLaunchingGateway;
}
```

13.3.1. Providing Feedback with Informational Messages

As Spring Batch jobs can run for long times, providing progress information is often critical. For example, stake-holders may want to be notified if some or all parts of a batch job have failed. Spring Batch provides support for this information being gathered through:

- Active polling
- Event-driven listeners

When starting a Spring Batch job asynchronously (for example, by using the `Job Launching Gateway`), a `JobExecution` instance is returned. Thus, `JobExecution.getJobId()` can be used to continuously poll for status updates by retrieving updated instances of the `JobExecution` from the `JobRepository` by using the `JobExplorer`. However, this is considered sub-optimal, and an event-driven approach should be preferred.

Therefore, Spring Batch provides listeners, including the three most commonly used listeners:

- `StepListener`
- `ChunkListener`
- `JobExecutionListener`

In the example shown in the following image, a Spring Batch job has been configured with a `StepExecutionListener`. Thus, Spring Integration receives and processes any step before or after events. For example, the received `StepExecution` can be inspected by using a `Router`. Based on the results of that inspection, various things can occur (such as routing a message to a Mail Outbound

Channel Adapter), so that an Email notification can be sent out based on some condition.

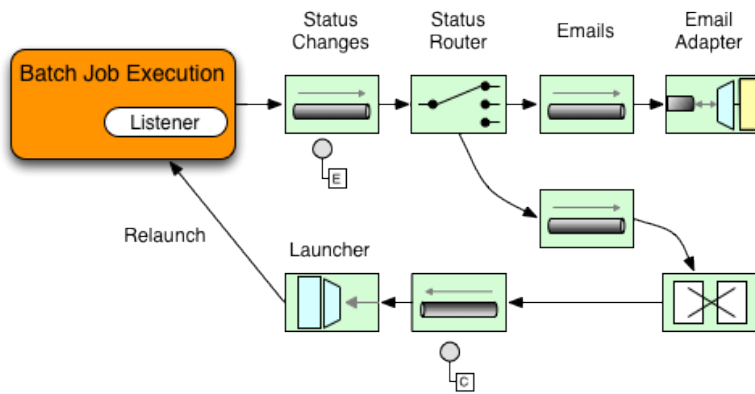

Figure 28. Handling Informational Messages

The following two-part example shows how a listener is configured to send a message to a `Gateway` for a `StepExecution` events and log its output to a `logging-channel-adapter`.

First, create the notification integration beans:

XML Configuration

```
<int:channel id="stepExecutionsChannel"/>

<int:gateway id="notificationExecutionsListener"
  service-interface="org.springframework.batch.core.StepExecutionListener"
  default-request-channel="stepExecutionsChannel"/>

<int:logging-channel-adapter channel="stepExecutionsChannel"/>
```

Java Configuration

```
@Bean
@ServiceActivator(inputChannel = "stepExecutionsChannel")
public LoggingHandler loggingHandler() {
    LoggingHandler adapter = new LoggingHandler(LoggingHandler.Level.WARN);
    adapter.setLoggerName("TEST_LOGGER");
    adapter.setLogExpressionString("headers.id + ': ' + payload");
    return adapter;
}

@MessagingGateway(name = "notificationExecutionsListener", defaultRequestChannel =
"stepExecutionsChannel")
public interface NotificationExecutionListener extends StepExecutionListener {}
```



You will need to add the `@IntegrationComponentScan` annotation to your configuration.

Second, modify your job to add a step-level listener:

XML Configuration

```
<job id="importPayments">
  <step id="step1">
    <tasklet ../>
      <chunk ../>
        <listeners>
          <listener ref="notificationExecutionsListener"/>
        </listeners>
      </tasklet>
      ...
    </step>
  </job>
```

Java Configuration

```
public Job importPaymentsJob() {
    return jobBuilderFactory.get("importPayments")
        .start(stepBuilderFactory.get("step1")
            .chunk(200)
            .listener(notificationExecutionsListener())
            ...
        )
}
```

13.3.2. Asynchronous Processors

Asynchronous Processors help you to scale the processing of items. In the asynchronous processor use case, an `AsyncItemProcessor` serves as a dispatcher, executing the logic of the `ItemProcessor` for an item on a new thread. Once the item completes, the `Future` is passed to the `AsyncItemWriter` to be written.

Therefore, you can increase performance by using asynchronous item processing, basically allowing you to implement *fork-join* scenarios. The `AsyncItemWriter` gathers the results and writes back the chunk as soon as all the results become available.

The following example shows how to configuration the `AsyncItemProcessor`:

XML Configuration

```
<bean id="processor"
    class="org.springframework.batch.integration.async.AsyncItemProcessor">
  <property name="delegate">
    <bean class="your.ItemProcessor"/>
  </property>
  <property name="taskExecutor">
    <bean class="org.springframework.core.task.SimpleAsyncTaskExecutor"/>
  </property>
</bean>
```

Java Configuration

```
@Bean
public AsyncItemProcessor processor(ItemProcessor itemProcessor, TaskExecutor
taskExecutor) {
    AsyncItemProcessor asyncItemProcessor = new AsyncItemProcessor();
    asyncItemProcessor.setTaskExecutor(taskExecutor);
    asyncItemProcessor.setDelegate(itemProcessor);
    return asyncItemProcessor;
}
```

The `delegate` property refers to your `ItemProcessor` bean, and the `taskExecutor` property refers to the `TaskExecutor` of your choice.

The following example shows how to configure the `AsyncItemWriter`:

XML Configuration

```
<bean id="itemWriter"
    class="org.springframework.batch.integration.async.AsyncItemWriter">
    <property name="delegate">
        <bean id="itemWriter" class="your.ItemWriter"/>
    </property>
</bean>
```

Java Configuration

```
@Bean
public AsyncItemWriter writer(ItemWriter itemWriter) {
    AsyncItemWriter asyncItemWriter = new AsyncItemWriter();
    asyncItemWriter.setDelegate(itemWriter);
    return asyncItemWriter;
}
```

Again, the `delegate` property is actually a reference to your `ItemWriter` bean.

13.3.3. Externalizing Batch Process Execution

The integration approaches discussed so far suggest use cases where Spring Integration wraps Spring Batch like an outer-shell. However, Spring Batch can also use Spring Integration internally. Using this approach, Spring Batch users can delegate the processing of items or even chunks to outside processes. This allows you to offload complex processing. Spring Batch Integration provides dedicated support for:

- Remote Chunking
- Remote Partitioning

Remote Chunking

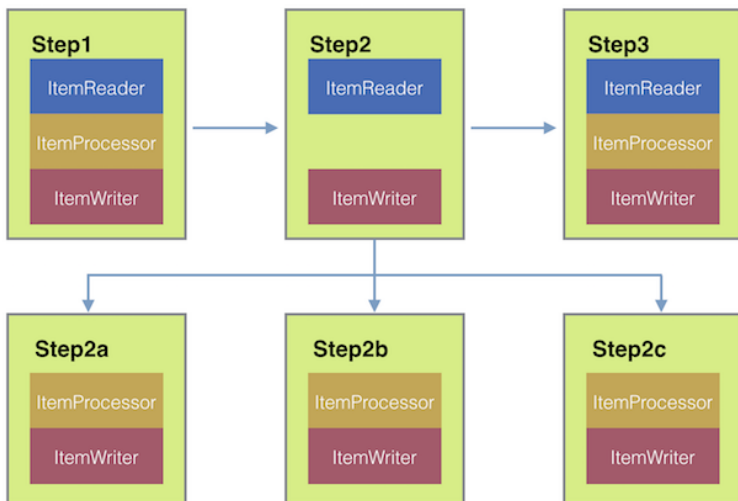

Figure 29. Remote Chunking

Taking things one step further, one can also externalize the chunk processing by using the `ChunkMessageChannelItemWriter` (provided by Spring Batch Integration), which sends items out and collects the result. Once sent, Spring Batch continues the process of reading and grouping items, without waiting for the results. Rather, it is the responsibility of the `ChunkMessageChannelItemWriter` to gather the results and integrate them back into the Spring Batch process.

With Spring Integration, you have full control over the concurrency of your processes (for instance, by using a `QueueChannel` instead of a `DirectChannel`). Furthermore, by relying on Spring Integration's rich collection of Channel Adapters (such as JMS and AMQP), you can distribute chunks of a Batch job to external systems for processing.

A simple job with a step to be remotely chunked might have a configuration similar to the following:

XML Configuration

```
<job id="personJob">
  <step id="step1">
    <tasklet>
      <chunk reader="itemReader" writer="itemWriter" commit-interval="200"/>
    </tasklet>
    ...
  </step>
</job>
```

Java Configuration

```
public Job chunkJob() {
    return jobBuilderFactory.get("personJob")
        .start(stepBuilderFactory.get("step1")
            .<Person, Person>chunk(200)
            .reader(itemReader())
            .writer(itemWriter())
            .build())
        .build();
}
```

The `ItemReader` reference points to the bean you want to use for reading data on the manager. The `ItemWriter` reference points to a special `ItemWriter` (called `ChunkMessageChannelItemWriter`), as described above. The processor (if any) is left off the manager configuration, as it is configured on the worker. The following configuration provides a basic manager setup. You should check any additional component properties, such as throttle limits and so on, when implementing your use case.

XML Configuration

```
<bean id="connectionFactory" class="org.apache.activemq.ActiveMQConnectionFactory">
    <property name="brokerURL" value="tcp://localhost:61616"/>
</bean>

<int-jms:outbound-channel-adapter id="jmsRequests" destination-name="requests"/>

<bean id="messagingTemplate"
    class="org.springframework.integration.core.MessagingTemplate">
    <property name="defaultChannel" ref="requests"/>
    <property name="receiveTimeout" value="2000"/>
</bean>

<bean id="itemWriter"
    class="org.springframework.batch.integration.chunk.ChunkMessageChannelItemWriter"
    scope="step">
    <property name="messagingOperations" ref="messagingTemplate"/>
    <property name="replyChannel" ref="replies"/>
</bean>

<int:channel id="replies">
    <int:queue/>
</int:channel>

<int-jms:message-driven-channel-adapter id="jmsReplies"
    destination-name="replies"
    channel="replies"/>
```

Java Configuration

```

@Bean
public org.apache.activemq.ActiveMQConnectionFactory connectionFactory() {
    ActiveMQConnectionFactory factory = new ActiveMQConnectionFactory();
    factory.setBrokerURL("tcp://localhost:61616");
    return factory;
}

/*
 * Configure outbound flow (requests going to workers)
 */
@Bean
public DirectChannel requests() {
    return new DirectChannel();
}

@Bean
public IntegrationFlow outboundFlow(ActiveMQConnectionFactory connectionFactory) {
    return IntegrationFlows
        .from(requests())
        .handle(Jms.outboundAdapter(connectionFactory).destination("requests"))
        .get();
}

/*
 * Configure inbound flow (replies coming from workers)
 */
@Bean
public QueueChannel replies() {
    return new QueueChannel();
}

@Bean
public IntegrationFlow inboundFlow(ActiveMQConnectionFactory connectionFactory) {
    return IntegrationFlows
        .from(Jms.messageDrivenChannelAdapter(connectionFactory).destination(
            "replies"))
        .channel(replies())
        .get();
}

/*
 * Configure the ChunkMessageChannelItemWriter
 */
@Bean
public ItemWriter<Integer> itemWriter() {
    MessagingTemplate messagingTemplate = new MessagingTemplate();
    messagingTemplate.setDefaultChannel(requests());
    messagingTemplate.setReceiveTimeout(2000);
    ChunkMessageChannelItemWriter<Integer> chunkMessageChannelItemWriter
        = new ChunkMessageChannelItemWriter<>();
    chunkMessageChannelItemWriter.setMessagingOperations(messagingTemplate);
}

```

```

    chunkMessageChannelItemWriter.setReplyChannel(replies());
    return chunkMessageChannelItemWriter;
}

```

The preceding configuration provides us with a number of beans. We configure our messaging middleware using ActiveMQ and the inbound/outbound JMS adapters provided by Spring Integration. As shown, our `itemWriter` bean, which is referenced by our job step, uses the `ChunkMessageChannelItemWriter` for writing chunks over the configured middleware.

Now we can move on to the worker configuration, as shown in the following example:

XML Configuration

```

<bean id="connectionFactory" class="org.apache.activemq.ActiveMQConnectionFactory">
  <property name="brokerURL" value="tcp://localhost:61616"/>
</bean>

<int:channel id="requests"/>
<int:channel id="replies"/>

<int-jms:message-driven-channel-adapter id="incomingRequests"
  destination-name="requests"
  channel="requests"/>

<int-jms:outbound-channel-adapter id="outgoingReplies"
  destination-name="replies"
  channel="replies">
</int-jms:outbound-channel-adapter>

<int:service-activator id="serviceActivator"
  input-channel="requests"
  output-channel="replies"
  ref="chunkProcessorChunkHandler"
  method="handleChunk"/>

<bean id="chunkProcessorChunkHandler"
  class="org.springframework.batch.integration.chunk.ChunkProcessorChunkHandler">
  <property name="chunkProcessor">
    <bean class="org.springframework.batch.core.step.item.SimpleChunkProcessor">
      <property name="itemWriter">
        <bean class="io.spring.sbi.PersonItemWriter"/>
      </property>
      <property name="itemProcessor">
        <bean class="io.spring.sbi.PersonItemProcessor"/>
      </property>
    </bean>
  </property>
</bean>

```

Java Configuration

```

@Bean
public org.apache.activemq.ActiveMQConnectionFactory connectionFactory() {
    ActiveMQConnectionFactory factory = new ActiveMQConnectionFactory();
    factory.setBrokerURL("tcp://localhost:61616");
    return factory;
}

/*
 * Configure inbound flow (requests coming from the manager)
 */
@Bean
public DirectChannel requests() {
    return new DirectChannel();
}

@Bean
public IntegrationFlow inboundFlow(ActiveMQConnectionFactory connectionFactory) {
    return IntegrationFlows
        .from(Jms.messageDrivenChannelAdapter(connectionFactory).destination(
            "requests"))
        .channel(requests())
        .get();
}

/*
 * Configure outbound flow (replies going to the manager)
 */
@Bean
public DirectChannel replies() {
    return new DirectChannel();
}

@Bean
public IntegrationFlow outboundFlow(ActiveMQConnectionFactory connectionFactory) {
    return IntegrationFlows
        .from(replies())
        .handle(Jms.outboundAdapter(connectionFactory).destination("replies"))
        .get();
}

/*
 * Configure the ChunkProcessorChunkHandler
 */
@Bean
@ServiceActivator(inputChannel = "requests", outputChannel = "replies")
public ChunkProcessorChunkHandler<Integer> chunkProcessorChunkHandler() {
    ChunkProcessor<Integer> chunkProcessor
        = new SimpleChunkProcessor<>(itemProcessor(), itemWriter());
    ChunkProcessorChunkHandler<Integer> chunkProcessorChunkHandler
        = new ChunkProcessorChunkHandler<>();
    chunkProcessorChunkHandler.setChunkProcessor(chunkProcessor);
}

```

```

return chunkProcessorChunkHandler;
}

```

Most of these configuration items should look familiar from the manager configuration. Workers do not need access to the Spring Batch `JobRepository` nor to the actual job configuration file. The main bean of interest is the `chunkProcessorChunkHandler`. The `chunkProcessor` property of `ChunkProcessorChunkHandler` takes a configured `SimpleChunkProcessor`, which is where you would provide a reference to your `ItemWriter` (and, optionally, your `ItemProcessor`) that will run on the worker when it receives chunks from the manager.

For more information, see the section of the "Scalability" chapter on [Remote Chunking](#).

Starting from version 4.1, Spring Batch Integration introduces the `@EnableBatchIntegration` annotation that can be used to simplify a remote chunking setup. This annotation provides two beans that can be autowired in the application context:

- `RemoteChunkingManagerStepBuilderFactory`: used to configure the manager step
- `RemoteChunkingWorkerBuilder`: used to configure the remote worker integration flow

These APIs take care of configuring a number of components as described in the following diagram:

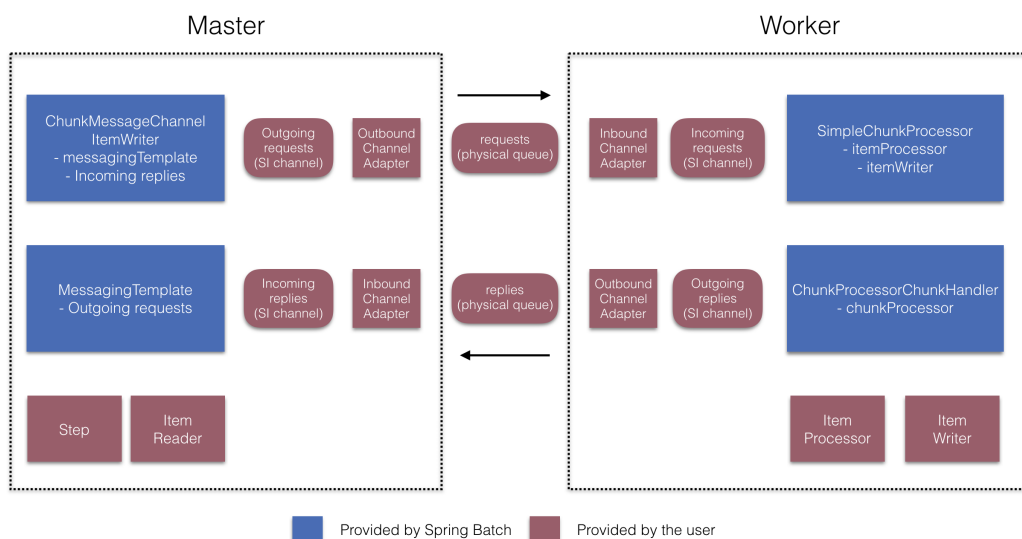

Figure 30. Remote Chunking Configuration

On the manager side, the `RemoteChunkingManagerStepBuilderFactory` lets you configure a manager step by declaring:

- the item reader to read items and send them to workers
- the output channel ("Outgoing requests") to send requests to workers
- the input channel ("Incoming replies") to receive replies from workers

A `ChunkMessageChannelItemWriter` and the `MessagingTemplate` are not needed to be explicitly configured (Those can still be explicitly configured if required).

On the worker side, the `RemoteChunkingWorkerBuilder` allows you to configure a worker to:

- listen to requests sent by the manager on the input channel ("Incoming requests")
- call the `handleChunk` method of `ChunkProcessorChunkHandler` for each request with the configured `ItemProcessor` and `ItemWriter`
- send replies on the output channel ("Outgoing replies") to the manager

There is no need to explicitly configure the `SimpleChunkProcessor` and the `ChunkProcessorChunkHandler` (Those can be explicitly configured if required).

The following example shows how to use these APIs:

```

@EnableBatchIntegration
@EnableBatchProcessing
public class RemoteChunkingJobConfiguration {

    @Configuration
    public static class ManagerConfiguration {

        @Autowired
        private RemoteChunkingManagerStepBuilderFactory managerStepBuilderFactory;

        @Bean
        public TaskletStep managerStep() {
            return this.managerStepBuilderFactory.get("managerStep")
                .chunk(100)
                .reader(itemReader())
                .outputChannel(requests()) // requests sent to workers
                .inputChannel(replies()) // replies received from workers
                .build();
        }

        // Middleware beans setup omitted
    }

    @Configuration
    public static class WorkerConfiguration {

        @Autowired
        private RemoteChunkingWorkerBuilder workerBuilder;

        @Bean
        public IntegrationFlow workerFlow() {
            return this.workerBuilder
                .itemProcessor(itemProcessor())
                .itemWriter(itemWriter())
                .inputChannel(requests()) // requests received from the manager
                .outputChannel(replies()) // replies sent to the manager
                .build();
        }

        // Middleware beans setup omitted
    }
}

```

You can find a complete example of a remote chunking job [here](#).

Remote Partitioning

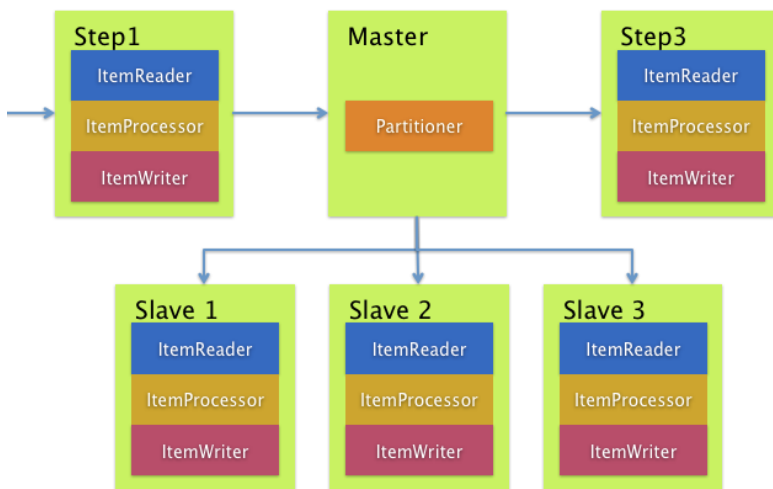

Figure 31. Remote Partitioning

Remote Partitioning, on the other hand, is useful when it is not the processing of items but rather the associated I/O that causes the bottleneck. Using Remote Partitioning, work can be farmed out to workers that execute complete Spring Batch steps. Thus, each worker has its own `ItemReader`, `ItemProcessor`, and `ItemWriter`. For this purpose, Spring Batch Integration provides the `MessageChannelPartitionHandler`.

This implementation of the `PartitionHandler` interface uses `MessageChannel` instances to send instructions to remote workers and receive their responses. This provides a nice abstraction from the transports (such as JMS and AMQP) being used to communicate with the remote workers.

The section of the "Scalability" chapter that addresses [remote partitioning](#) provides an overview of the concepts and components needed to configure remote partitioning and shows an example of using the default `TaskExecutorPartitionHandler` to partition in separate local threads of execution. For remote partitioning to multiple JVMs, two additional components are required:

- A remoting fabric or grid environment
- A `PartitionHandler` implementation that supports the desired remoting fabric or grid environment

Similar to remote chunking, JMS can be used as the "remoting fabric". In that case, use a `MessageChannelPartitionHandler` instance as the `PartitionHandler` implementation, as described above. The following example assumes an existing partitioned job and focuses on the `MessageChannelPartitionHandler` and JMS configuration:

XML Configuration

```
<bean id="partitionHandler"
      class=
"org.springframework.batch.integration.partition.MessageChannelPartitionHandler">
  <property name="stepName" value="step1"/>
  <property name="gridSize" value="3"/>
  <property name="replyChannel" ref="outbound-replies"/>
  <property name="messagingOperations">
```

```

<bean class="org.springframework.integration.core.MessagingTemplate">
  <property name="defaultChannel" ref="outbound-requests"/>
  <property name="receiveTimeout" value="100000"/>
</bean>
</property>
</bean>

<int:channel id="outbound-requests"/>
<int-jms:outbound-channel-adapter destination="requestsQueue"
  channel="outbound-requests"/>

<int:channel id="inbound-requests"/>
<int-jms:message-driven-channel-adapter destination="requestsQueue"
  channel="inbound-requests"/>

<bean id="stepExecutionRequestHandler"
  class="
org.springframework.batch.integration.partition.StepExecutionRequestHandler">
  <property name="jobExplorer" ref="jobExplorer"/>
  <property name="stepLocator" ref="stepLocator"/>
</bean>

<int:service-activator ref="stepExecutionRequestHandler" input-channel="inbound-
requests"
  output-channel="outbound-staging"/>

<int:channel id="outbound-staging"/>
<int-jms:outbound-channel-adapter destination="stagingQueue"
  channel="outbound-staging"/>

<int:channel id="inbound-staging"/>
<int-jms:message-driven-channel-adapter destination="stagingQueue"
  channel="inbound-staging"/>

<int:aggregator ref="partitionHandler" input-channel="inbound-staging"
  output-channel="outbound-replies"/>

<int:channel id="outbound-replies">
  <int:queue/>
</int:channel>

<bean id="stepLocator"
  class="org.springframework.batch.integration.partition.BeanFactoryStepLocator" />

```

Java Configuration

```

/*
 * Configuration of the manager side
 */
@Bean
public PartitionHandler partitionHandler() {

```



```

    MessageChannelPartitionHandler partitionHandler = new
MessageChannelPartitionHandler();
    partitionHandler.setStepName("step1");
    partitionHandler.setGridSize(3);
    partitionHandler.setReplyChannel(outboundReplies());
    MessagingTemplate template = new MessagingTemplate();
    template.setDefaultChannel(outboundRequests());
    template.setReceiveTimeout(100000);
    partitionHandler.setMessagingOperations(template);
    return partitionHandler;
}

@Bean
public QueueChannel outboundReplies() {
    return new QueueChannel();
}

@Bean
public DirectChannel outboundRequests() {
    return new DirectChannel();
}

@Bean
public IntegrationFlow outboundJmsRequests() {
    return IntegrationFlows.from("outboundRequests")
        .handle(Jms.outboundGateway(connectionFactory())
            .requestDestination("requestsQueue"))
        .get();
}

@Bean
@ServiceActivator(inputChannel = "inboundStaging")
public AggregatorFactoryBean partitioningMessageHandler() throws Exception {
    AggregatorFactoryBean aggregatorFactoryBean = new AggregatorFactoryBean();
    aggregatorFactoryBean.setProcessorBean(partitionHandler());
    aggregatorFactoryBean.setOutputChannel(outboundReplies());
    // configure other properties of the aggregatorFactoryBean
    return aggregatorFactoryBean;
}

@Bean
public DirectChannel inboundStaging() {
    return new DirectChannel();
}

@Bean
public IntegrationFlow inboundJmsStaging() {
    return IntegrationFlows
        .from(Jms.messageDrivenChannelAdapter(connectionFactory())
            .configureListenerContainer(c -> c.subscriptionDurable(false))
            .destination("stagingQueue"))

```

```

        .channel(inboundStaging())
        .get();
    }

    /*
     * Configuration of the worker side
     */
    @Bean
    public StepExecutionRequestHandler stepExecutionRequestHandler() {
        StepExecutionRequestHandler stepExecutionRequestHandler = new
        StepExecutionRequestHandler();
        stepExecutionRequestHandler.setJobExplorer(jobExplorer);
        stepExecutionRequestHandler.setStepLocator(stepLocator());
        return stepExecutionRequestHandler;
    }

    @Bean
    @ServiceActivator(inputChannel = "inboundRequests", outputChannel = "outboundStaging")
    public StepExecutionRequestHandler serviceActivator() throws Exception {
        return stepExecutionRequestHandler();
    }

    @Bean
    public DirectChannel inboundRequests() {
        return new DirectChannel();
    }

    public IntegrationFlow inboundJmsRequests() {
        return IntegrationFlows
            .from(Jms.messageDrivenChannelAdapter(connectionFactory())
                .configureListenerContainer(c -> c.subscriptionDurable(false))
                .destination("requestsQueue"))
            .channel(inboundRequests())
            .get();
    }

    @Bean
    public DirectChannel outboundStaging() {
        return new DirectChannel();
    }

    @Bean
    public IntegrationFlow outboundJmsStaging() {
        return IntegrationFlows.from("outboundStaging")
            .handle(Jms.outboundGateway(connectionFactory())
                .requestDestination("stagingQueue"))
            .get();
    }
}

```

You must also ensure that the partition `handler` attribute maps to the `partitionHandler` bean, as

shown in the following example:

XML Configuration

```
<job id="personJob">
  <step id="step1.manager">
    <partition partitioner="partitioner" handler="partitionHandler"/>
    ...
  </step>
</job>
```

Java Configuration

```
public Job personJob() {
    return jobBuilderFactory.get("personJob")
        .start(stepBuilderFactory.get("step1.manager")
            .partitioner("step1.worker", partitioner())
            .partitionHandler(partitionHandler())
            .build())
        .build();
}
```

You can find a complete example of a remote partitioning job [here](#).

The `@EnableBatchIntegration` annotation that can be used to simplify a remote partitioning setup. This annotation provides two beans useful for remote partitioning:

- `RemotePartitioningManagerStepBuilderFactory`: used to configure the manager step
- `RemotePartitioningWorkerStepBuilderFactory`: used to configure the worker step

These APIs take care of configuring a number of components as described in the following diagram:

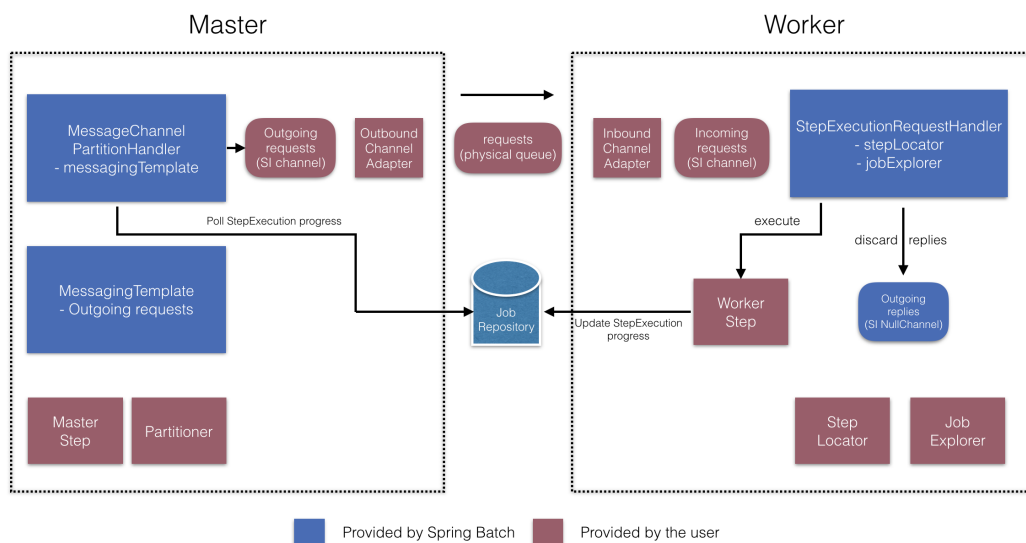

Figure 32. Remote Partitioning Configuration (with job repository polling)

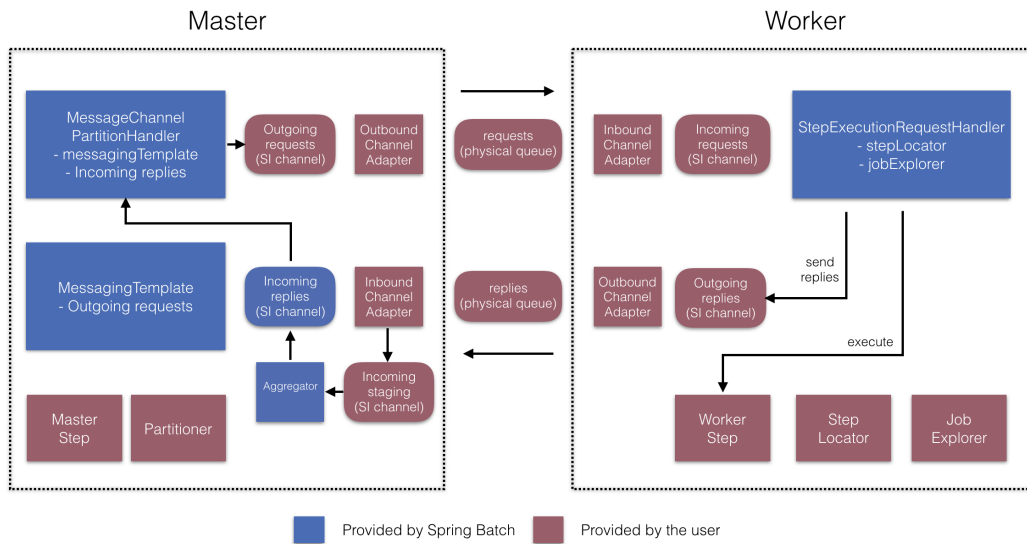

Figure 33. Remote Partitioning Configuration (with replies aggregation)

On the manager side, the `RemotePartitioningManagerStepBuilderFactory` allows you to configure a manager step by declaring:

- the `Partitioner` used to partition data
- the output channel ("Outgoing requests") to send requests to workers
- the input channel ("Incoming replies") to receive replies from workers (when configuring replies aggregation)
- the poll interval and timeout parameters (when configuring job repository polling)

The `MessageChannelPartitionHandler` and the `MessagingTemplate` are not needed to be explicitly configured (Those can still be explicitly configured if required).

On the worker side, the `RemotePartitioningWorkerStepBuilderFactory` allows you to configure a worker to:

- listen to requests sent by the manager on the input channel ("Incoming requests")
- call the `handle` method of `StepExecutionRequestHandler` for each request
- send replies on the output channel ("Outgoing replies") to the manager

There is no need to explicitly configure the `StepExecutionRequestHandler` (which can be explicitly configured if required).

The following example shows how to use these APIs:

```

@Configuration
@EnableBatchProcessing
@EnableBatchIntegration
public class RemotePartitioningJobConfiguration {

    @Configuration
    public static class ManagerConfiguration {

        @Autowired
        private RemotePartitioningManagerStepBuilderFactory managerStepBuilderFactory;

        @Bean
        public Step managerStep() {
            return this.managerStepBuilderFactory
                .get("managerStep")
                .partitioner("workerStep", partitioner())
                .gridSize(10)
                .outputChannel(outgoingRequestsToWorkers())
                .inputChannel(incomingRepliesFromWorkers())
                .build();
        }

        // Middleware beans setup omitted
    }

    @Configuration
    public static class WorkerConfiguration {

        @Autowired
        private RemotePartitioningWorkerStepBuilderFactory workerStepBuilderFactory;

        @Bean
        public Step workerStep() {
            return this.workerStepBuilderFactory
                .get("workerStep")
                .inputChannel(incomingRequestsFromManager())
                .outputChannel(outgoingRepliesToManager())
                .chunk(100)
                .reader(itemReader())
                .processor(itemProcessor())
                .writer(itemWriter())
                .build();
        }

        // Middleware beans setup omitted
    }
}

```

Chapter 14. Monitoring and metrics

Since version 4.2, Spring Batch provides support for batch monitoring and metrics based on [Micrometer](#). This section describes which metrics are provided out-of-the-box and how to contribute custom metrics.

14.1. Built-in metrics

Metrics collection does not require any specific configuration. All metrics provided by the framework are registered in [Micrometer's global registry](#) under the `spring.batch` prefix. The following table explains all the metrics in details:

<i>Metric Name</i>	<i>Type</i>	<i>Description</i>
<code>spring.batch.job</code>	TIMER	Duration of job execution
<code>spring.batch.job.active</code>	LONG_TASK_TIMER	Currently active jobs
<code>spring.batch.step</code>	TIMER	Duration of step execution
<code>spring.batch.item.read</code>	TIMER	Duration of item reading
<code>spring.batch.item.process</code>	TIMER	Duration of item processing
<code>spring.batch.chunk.write</code>	TIMER	Duration of chunk writing

14.2. Custom metrics

If you want to use your own metrics in your custom components, we recommend using Micrometer APIs directly. The following is an example of how to time a `Tasklet`:

```

import io.micrometer.core.instrument.Metrics;
import io.micrometer.core.instrument.Timer;

import org.springframework.batch.core.StepContribution;
import org.springframework.batch.core.scope.context.ChunkContext;
import org.springframework.batch.core.step.tasklet.Tasklet;
import org.springframework.batch.repeat.RepeatStatus;

public class MyTimedTasklet implements Tasklet {

    @Override
    public RepeatStatus execute(StepContribution contribution, ChunkContext
chunkContext) {
        Timer.Sample sample = Timer.start(Metrics.globalRegistry);
        String status = "success";
        try {
            // do some work
        } catch (Exception e) {
            // handle exception
            status = "failure";
        } finally {
            sample.stop(Timer.builder("my.tasklet.timer")
                .description("Duration of MyTimedTasklet")
                .tag("status", status)
                .register(Metrics.globalRegistry));
        }
        return RepeatStatus.FINISHED;
    }
}

```

Appendix A: List of ItemReaders and ItemWriters

A.1. Item Readers

Table 19. Available Item Readers

Item Reader	Description
AbstractItemCountingItemStreamItemReader	Abstract base class that provides basic restart capabilities by counting the number of items returned from an <code>ItemReader</code> .
AggregateItemReader	An <code>ItemReader</code> that delivers a list as its item, storing up objects from the injected <code>ItemReader</code> until they are ready to be packed out as a collection. This class must be used as a wrapper for a custom <code>ItemReader</code> that can identify the record boundaries. The custom reader should mark the beginning and end of records by returning an <code>AggregateItem</code> which responds <code>true</code> to its query methods <code>isHeader()</code> and <code>isFooter()</code> . Note that this reader is not part of the library of readers provided by Spring Batch but given as a sample in <code>spring-batch-samples</code> .
AmqpItemReader	Given a Spring <code>AmqpTemplate</code> , it provides synchronous receive methods. The <code>receiveAndConvert()</code> method lets you receive POJO objects.
KafkaItemReader	An <code>ItemReader</code> that reads messages from an Apache Kafka topic. It can be configured to read messages from multiple partitions of the same topic. This reader stores message offsets in the execution context to support restart capabilities.
FlatFileItemReader	Reads from a flat file. Includes <code>ItemStream</code> and <code>Skippable</code> functionality. See <code>FlatFileItemReader</code> .
HibernateCursorItemReader	Reads from a cursor based on an HQL query. See <code>Cursor-based ItemReaders</code> .
HibernatePagingItemReader	Reads from a paginated HQL query
ItemReaderAdapter	Adapts any class to the <code>ItemReader</code> interface.
JdbcCursorItemReader	Reads from a database cursor via JDBC. See <code>Cursor-based ItemReaders</code> .
JdbcPagingItemReader	Given an SQL statement, pages through the rows, such that large datasets can be read without running out of memory.

Item Reader	Description
JmsItemReader	Given a Spring <code>JmsOperations</code> object and a JMS Destination or destination name to which to send errors, provides items received through the injected <code>JmsOperations#receive()</code> method.
JpaPagingItemReader	Given a JPQL statement, pages through the rows, such that large datasets can be read without running out of memory.
ListItemReader	Provides the items from a list, one at a time.
MongoItemReader	Given a <code>MongoOperations</code> object and a JSON-based MongoDB query, provides items received from the <code>MongoOperations#find()</code> method.
Neo4jItemReader	Given a <code>Neo4jOperations</code> object and the components of a Cypher query, items are returned as the result of the <code>Neo4jOperations.query</code> method.
RepositoryItemReader	Given a Spring Data <code>PagingAndSortingRepository</code> object, a <code>Sort</code> , and the name of method to execute, returns items provided by the Spring Data repository implementation.
StoredProcedureItemReader	Reads from a database cursor resulting from the execution of a database stored procedure. See <code>StoredProcedureItemReader</code>
StaxEventItemReader	Reads via StAX. see <code>StaxEventItemReader</code> .
JsonItemReader	Reads items from a Json document. see <code>JsonItemReader</code> .

A.2. Item Writers

Table 20. Available Item Writers

Item Writer	Description
AbstractItemStreamItemWriter	Abstract base class that combines the <code>ItemStream</code> and <code>ItemWriter</code> interfaces.
AmqpItemWriter	Given a Spring <code>AmqpTemplate</code> , it provides for a synchronous <code>send</code> method. The <code>convertAndSend(Object)</code> method lets you send POJO objects.
CompositeItemWriter	Passes an item to the <code>write</code> method of each in an injected <code>List</code> of <code>ItemWriter</code> objects.
FlatFileItemWriter	Writes to a flat file. Includes <code>ItemStream</code> and Skippable functionality. See <code>FlatFileItemWriter</code> .
GemfireItemWriter	Using a <code>GemfireOperations</code> object, items are either written or removed from the Gemfire instance based on the configuration of the delete flag.

Item Writer	Description
HibernateItemWriter	This item writer is Hibernate-session aware and handles some transaction-related work that a non-"hibernate-aware" item writer would not need to know about and then delegates to another item writer to do the actual writing.
ItemWriterAdapter	Adapts any class to the <code>ItemWriter</code> interface.
JdbcBatchItemWriter	Uses batching features from a <code>PreparedStatement</code> , if available, and can take rudimentary steps to locate a failure during a <code>flush</code> .
JmsItemWriter	Using a <code>JmsOperations</code> object, items are written to the default queue through the <code>JmsOperations#convertAndSend()</code> method.
JpaItemWriter	This item writer is JPA EntityManager-aware and handles some transaction-related work that a non-"JPA-aware" <code>ItemWriter</code> would not need to know about and then delegates to another writer to do the actual writing.
KafkaItemWriter	Using a <code>KafkaTemplate</code> object, items are written to the default topic through the <code>KafkaTemplate#sendDefault(Object, Object)</code> method using a <code>Converter</code> to map the key from the item. A delete flag can also be configured to send delete events to the topic.
MimeMessageItemWriter	Using Spring's <code>JavaMailSender</code> , items of type <code>MimeMessage</code> are sent as mail messages.
MongoItemWriter	Given a <code>MongoOperations</code> object, items are written through the <code>MongoOperations.save(Object)</code> method. The actual write is delayed until the last possible moment before the transaction commits.
Neo4jItemWriter	Given a <code>Neo4jOperations</code> object, items are persisted through the <code>save(Object)</code> method or deleted through the <code>delete(Object)</code> per the <code>ItemWriter</code> 's configuration
PropertyExtractingDelegatingItemWriter	Extends <code>AbstractMethodInvokingDelegator</code> creating arguments on the fly. Arguments are created by retrieving the values from the fields in the item to be processed (through a <code>SpringBeanWrapper</code>), based on an injected array of field names.
RepositoryItemWriter	Given a Spring Data <code>CrudRepository</code> implementation, items are saved through the method specified in the configuration.
StaxEventItemWriter	Uses a <code>Marshaller</code> implementation to convert each item to XML and then writes it to an XML file using StAX.

Item Writer	Description
JsonFileItemWriter	Uses a <code>JsonObjectMarshaller</code> implementation to convert each item to Json and then writes it to an Json file.

Appendix B: Meta-Data Schema

B.1. Overview

The Spring Batch Metadata tables closely match the Domain objects that represent them in Java. For example, `JobInstance`, `JobExecution`, `JobParameters`, and `StepExecution` map to `BATCH_JOB_INSTANCE`, `BATCH_JOB_EXECUTION`, `BATCH_JOB_EXECUTION_PARAMS`, and `BATCH_STEP_EXECUTION`, respectively. `ExecutionContext` maps to both `BATCH_JOB_EXECUTION_CONTEXT` and `BATCH_STEP_EXECUTION_CONTEXT`. The `JobRepository` is responsible for saving and storing each Java object into its correct table. This appendix describes the metadata tables in detail, along with many of the design decisions that were made when creating them. When viewing the various table creation statements below, it is important to realize that the data types used are as generic as possible. Spring Batch provides many schemas as examples, all of which have varying data types, due to variations in how individual database vendors handle data types. The following image shows an ERD model of all 6 tables and their relationships to one another:

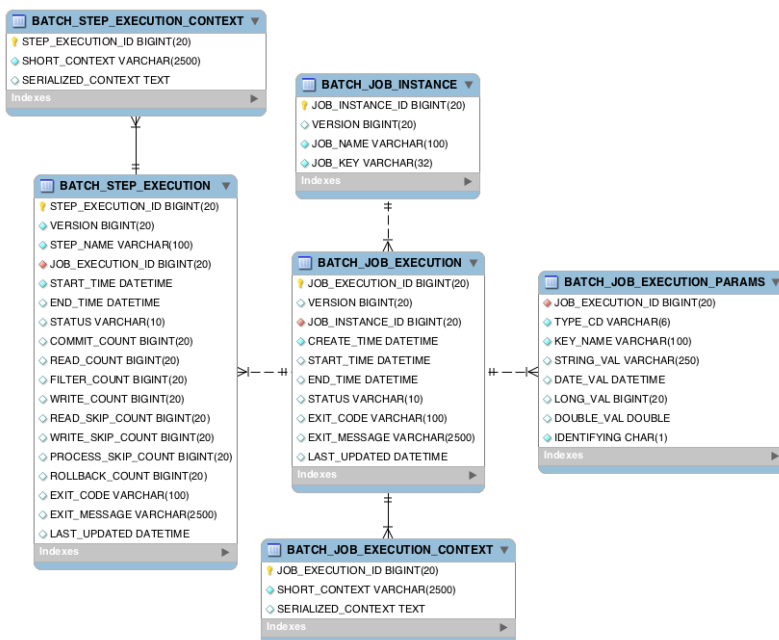

Figure 34. Spring Batch Meta-Data ERD

B.1.1. Example DDL Scripts

The Spring Batch Core JAR file contains example scripts to create the relational tables for a number of database platforms (which are, in turn, auto-detected by the job repository factory bean or namespace equivalent). These scripts can be used as is or modified with additional indexes and constraints as desired. The file names are in the form `schema-*.sql`, where "*" is the short name of the target database platform. The scripts are in the package `org.springframework.batch.core`.

B.1.2. Migration DDL Scripts

Spring Batch provides migration DDL scripts that you need to execute when you upgrade versions. These scripts can be found in the Core Jar file under `org/springframework/batch/core/migration`. Migration scripts are organized into folders corresponding to version numbers in which they were

introduced:

- [2.2](#): contains scripts needed if you are migrating from a version before [2.2](#) to version [2.2](#)
- [4.1](#): contains scripts needed if you are migrating from a version before [4.1](#) to version [4.1](#)

B.1.3. Version

Many of the database tables discussed in this appendix contain a version column. This column is important because Spring Batch employs an optimistic locking strategy when dealing with updates to the database. This means that each time a record is 'touched' (updated) the value in the version column is incremented by one. When the repository goes back to save the value, if the version number has changed it throws an `OptimisticLockingFailureException`, indicating there has been an error with concurrent access. This check is necessary, since, even though different batch jobs may be running in different machines, they all use the same database tables.

B.1.4. Identity

`BATCH_JOB_INSTANCE`, `BATCH_JOB_EXECUTION`, and `BATCH_STEP_EXECUTION` each contain columns ending in `_ID`. These fields act as primary keys for their respective tables. However, they are not database generated keys. Rather, they are generated by separate sequences. This is necessary because, after inserting one of the domain objects into the database, the key it is given needs to be set on the actual object so that they can be uniquely identified in Java. Newer database drivers (JDBC 3.0 and up) support this feature with database-generated keys. However, rather than require that feature, sequences are used. Each variation of the schema contains some form of the following statements:

```
CREATE SEQUENCE BATCH_STEP_EXECUTION_SEQ;  
CREATE SEQUENCE BATCH_JOB_EXECUTION_SEQ;  
CREATE SEQUENCE BATCH_JOB_SEQ;
```

Many database vendors do not support sequences. In these cases, work-arounds are used, such as the following statements for MySQL:

```
CREATE TABLE BATCH_STEP_EXECUTION_SEQ (ID BIGINT NOT NULL) type=InnoDB;  
INSERT INTO BATCH_STEP_EXECUTION_SEQ values(0);  
CREATE TABLE BATCH_JOB_EXECUTION_SEQ (ID BIGINT NOT NULL) type=InnoDB;  
INSERT INTO BATCH_JOB_EXECUTION_SEQ values(0);  
CREATE TABLE BATCH_JOB_SEQ (ID BIGINT NOT NULL) type=InnoDB;  
INSERT INTO BATCH_JOB_SEQ values(0);
```

In the preceding case, a table is used in place of each sequence. The Spring core class, `MySQLMaxValueIncrementer`, then increments the one column in this sequence in order to give similar functionality.

B.2. BATCH_JOB_INSTANCE

The `BATCH_JOB_INSTANCE` table holds all information relevant to a `JobInstance`, and serves as the top

of the overall hierarchy. The following generic DDL statement is used to create it:

```
CREATE TABLE BATCH_JOB_INSTANCE (
  JOB_INSTANCE_ID BIGINT PRIMARY KEY ,
  VERSION BIGINT,
  JOB_NAME VARCHAR(100) NOT NULL ,
  JOB_KEY VARCHAR(2500)
);
```

The following list describes each column in the table:

- **JOB_INSTANCE_ID**: The unique ID that identifies the instance. It is also the primary key. The value of this column should be obtainable by calling the `getId` method on `JobInstance`.
- **VERSION**: See [Version](#).
- **JOB_NAME**: Name of the job obtained from the `Job` object. Because it is required to identify the instance, it must not be null.
- **JOB_KEY**: A serialization of the `JobParameters` that uniquely identifies separate instances of the same job from one another. (`JobInstances` with the same job name must have different `JobParameters` and, thus, different `JOB_KEY` values).

B.3. BATCH_JOB_EXECUTION_PARAMS

The `BATCH_JOB_EXECUTION_PARAMS` table holds all information relevant to the `JobParameters` object. It contains 0 or more key/value pairs passed to a `Job` and serves as a record of the parameters with which a job was run. For each parameter that contributes to the generation of a job's identity, the `IDENTIFYING` flag is set to true. Note that the table has been denormalized. Rather than creating a separate table for each type, there is one table with a column indicating the type, as shown in the following listing:

```
CREATE TABLE BATCH_JOB_EXECUTION_PARAMS (
  JOB_EXECUTION_ID BIGINT NOT NULL ,
  TYPE_CD VARCHAR(6) NOT NULL ,
  KEY_NAME VARCHAR(100) NOT NULL ,
  STRING_VAL VARCHAR(250) ,
  DATE_VAL DATETIME DEFAULT NULL ,
  LONG_VAL BIGINT ,
  DOUBLE_VAL DOUBLE PRECISION ,
  IDENTIFYING CHAR(1) NOT NULL ,
  constraint JOB_EXEC_PARAMS_FK foreign key (JOB_EXECUTION_ID)
  references BATCH_JOB_EXECUTION(JOB_EXECUTION_ID)
);
```

The following list describes each column:

- **JOB_EXECUTION_ID**: Foreign key from the `BATCH_JOB_EXECUTION` table that indicates the job execution to which the parameter entry belongs. Note that multiple rows (that is, key/value

pairs) may exist for each execution.

- **TYPE_CD**: String representation of the type of value stored, which can be a string, a date, a long, or a double. Because the type must be known, it cannot be null.
- **KEY_NAME**: The parameter key.
- **STRING_VAL**: Parameter value, if the type is string.
- **DATE_VAL**: Parameter value, if the type is date.
- **LONG_VAL**: Parameter value, if the type is long.
- **DOUBLE_VAL**: Parameter value, if the type is double.
- **IDENTIFYING**: Flag indicating whether the parameter contributed to the identity of the related **JobInstance**.

Note that there is no primary key for this table. This is because the framework has no use for one and, thus, does not require it. If need be, you can add a primary key may be added with a database generated key without causing any issues to the framework itself.

B.4. BATCH_JOB_EXECUTION

The **BATCH_JOB_EXECUTION** table holds all information relevant to the **JobExecution** object. Every time a **Job** is run, there is always a new **JobExecution**, and a new row in this table. The following listing shows the definition of the **BATCH_JOB_EXECUTION** table:

```
CREATE TABLE BATCH_JOB_EXECUTION (  
  JOB_EXECUTION_ID BIGINT PRIMARY KEY ,  
  VERSION BIGINT ,  
  JOB_INSTANCE_ID BIGINT NOT NULL ,  
  CREATE_TIME TIMESTAMP NOT NULL ,  
  START_TIME TIMESTAMP DEFAULT NULL ,  
  END_TIME TIMESTAMP DEFAULT NULL ,  
  STATUS VARCHAR(10) ,  
  EXIT_CODE VARCHAR(20) ,  
  EXIT_MESSAGE VARCHAR(2500) ,  
  LAST_UPDATED TIMESTAMP ,  
  JOB_CONFIGURATION_LOCATION VARCHAR(2500) NULL ,  
  constraint JOB_INSTANCE_EXECUTION_FK foreign key (JOB_INSTANCE_ID)  
  references BATCH_JOB_INSTANCE(JOB_INSTANCE_ID)  
) ;
```

The following list describes each column:

- **JOB_EXECUTION_ID**: Primary key that uniquely identifies this execution. The value of this column is obtainable by calling the **getId** method of the **JobExecution** object.
- **VERSION**: See **Version**.
- **JOB_INSTANCE_ID**: Foreign key from the **BATCH_JOB_INSTANCE** table. It indicates the instance to which this execution belongs. There may be more than one execution per instance.

- **CREATE_TIME**: Timestamp representing the time when the execution was created.
- **START_TIME**: Timestamp representing the time when the execution was started.
- **END_TIME**: Timestamp representing the time when the execution finished, regardless of success or failure. An empty value in this column when the job is not currently running indicates that there has been some type of error and the framework was unable to perform a last save before failing.
- **STATUS**: Character string representing the status of the execution. This may be **COMPLETED**, **STARTED**, and others. The object representation of this column is the **BatchStatus** enumeration.
- **EXIT_CODE**: Character string representing the exit code of the execution. In the case of a command-line job, this may be converted into a number.
- **EXIT_MESSAGE**: Character string representing a more detailed description of how the job exited. In the case of failure, this might include as much of the stack trace as is possible.
- **LAST_UPDATED**: Timestamp representing the last time this execution was persisted.

B.5. BATCH_STEP_EXECUTION

The **BATCH_STEP_EXECUTION** table holds all information relevant to the **StepExecution** object. This table is similar in many ways to the **BATCH_JOB_EXECUTION** table, and there is always at least one entry per **Step** for each **JobExecution** created. The following listing shows the definition of the **BATCH_STEP_EXECUTION** table:

```
CREATE TABLE BATCH_STEP_EXECUTION (
  STEP_EXECUTION_ID BIGINT PRIMARY KEY ,
  VERSION BIGINT NOT NULL,
  STEP_NAME VARCHAR(100) NOT NULL,
  JOB_EXECUTION_ID BIGINT NOT NULL,
  START_TIME TIMESTAMP NOT NULL ,
  END_TIME TIMESTAMP DEFAULT NULL,
  STATUS VARCHAR(10),
  COMMIT_COUNT BIGINT ,
  READ_COUNT BIGINT ,
  FILTER_COUNT BIGINT ,
  WRITE_COUNT BIGINT ,
  READ_SKIP_COUNT BIGINT ,
  WRITE_SKIP_COUNT BIGINT ,
  PROCESS_SKIP_COUNT BIGINT ,
  ROLLBACK_COUNT BIGINT ,
  EXIT_CODE VARCHAR(20) ,
  EXIT_MESSAGE VARCHAR(2500) ,
  LAST_UPDATED TIMESTAMP,
  constraint JOB_EXECUTION_STEP_FK foreign key (JOB_EXECUTION_ID)
  references BATCH_JOB_EXECUTION(JOB_EXECUTION_ID)
) ;
```

The following list describes for each column:

- **STEP_EXECUTION_ID**: Primary key that uniquely identifies this execution. The value of this column should be obtainable by calling the `getId` method of the `StepExecution` object.
- **VERSION**: See [Version](#).
- **STEP_NAME**: The name of the step to which this execution belongs.
- **JOB_EXECUTION_ID**: Foreign key from the `BATCH_JOB_EXECUTION` table. It indicates the `JobExecution` to which this `StepExecution` belongs. There may be only one `StepExecution` for a given `JobExecution` for a given `Step` name.
- **START_TIME**: Timestamp representing the time when the execution was started.
- **END_TIME**: Timestamp representing the time the when execution was finished, regardless of success or failure. An empty value in this column, even though the job is not currently running, indicates that there has been some type of error and the framework was unable to perform a last save before failing.
- **STATUS**: Character string representing the status of the execution. This may be `COMPLETED`, `STARTED`, and others. The object representation of this column is the `BatchStatus` enumeration.
- **COMMIT_COUNT**: The number of times in which the step has committed a transaction during this execution.
- **READ_COUNT**: The number of items read during this execution.
- **FILTER_COUNT**: The number of items filtered out of this execution.
- **WRITE_COUNT**: The number of items written and committed during this execution.
- **READ_SKIP_COUNT**: The number of items skipped on read during this execution.
- **WRITE_SKIP_COUNT**: The number of items skipped on write during this execution.
- **PROCESS_SKIP_COUNT**: The number of items skipped during processing during this execution.
- **ROLLBACK_COUNT**: The number of rollbacks during this execution. Note that this count includes each time rollback occurs, including rollbacks for retry and those in the skip recovery procedure.
- **EXIT_CODE**: Character string representing the exit code of the execution. In the case of a command-line job, this may be converted into a number.
- **EXIT_MESSAGE**: Character string representing a more detailed description of how the job exited. In the case of failure, this might include as much of the stack trace as is possible.
- **LAST_UPDATED**: Timestamp representing the last time this execution was persisted.

B.6. BATCH_JOB_EXECUTION_CONTEXT

The `BATCH_JOB_EXECUTION_CONTEXT` table holds all information relevant to the `ExecutionContext` of a `Job`. There is exactly one `Job ExecutionContext` per `JobExecution`, and it contains all of the job-level data that is needed for a particular job execution. This data typically represents the state that must be retrieved after a failure, so that a `JobInstance` can "start from where it left off". The following listing shows the definition of the `BATCH_JOB_EXECUTION_CONTEXT` table:

```
CREATE TABLE BATCH_JOB_EXECUTION_CONTEXT (
  JOB_EXECUTION_ID BIGINT PRIMARY KEY,
  SHORT_CONTEXT VARCHAR(2500) NOT NULL,
  SERIALIZED_CONTEXT CLOB,
  constraint JOB_EXEC_CTX_FK foreign key (JOB_EXECUTION_ID)
  references BATCH_JOB_EXECUTION(JOB_EXECUTION_ID)
) ;
```

The following list describes each column:

- **JOB_EXECUTION_ID**: Foreign key representing the `JobExecution` to which the context belongs. There may be more than one row associated with a given execution.
- **SHORT_CONTEXT**: A string version of the `SERIALIZED_CONTEXT`.
- **SERIALIZED_CONTEXT**: The entire context, serialized.

B.7. BATCH_STEP_EXECUTION_CONTEXT

The `BATCH_STEP_EXECUTION_CONTEXT` table holds all information relevant to the `ExecutionContext` of a `Step`. There is exactly one `ExecutionContext` per `StepExecution`, and it contains all of the data that needs to be persisted for a particular step execution. This data typically represents the state that must be retrieved after a failure, so that a `JobInstance` can 'start from where it left off'. The following listing shows the definition of the `BATCH_STEP_EXECUTION_CONTEXT` table:

```
CREATE TABLE BATCH_STEP_EXECUTION_CONTEXT (
  STEP_EXECUTION_ID BIGINT PRIMARY KEY,
  SHORT_CONTEXT VARCHAR(2500) NOT NULL,
  SERIALIZED_CONTEXT CLOB,
  constraint STEP_EXEC_CTX_FK foreign key (STEP_EXECUTION_ID)
  references BATCH_STEP_EXECUTION(STEP_EXECUTION_ID)
) ;
```

The following list describes each column:

- **STEP_EXECUTION_ID**: Foreign key representing the `StepExecution` to which the context belongs. There may be more than one row associated to a given execution.
- **SHORT_CONTEXT**: A string version of the `SERIALIZED_CONTEXT`.
- **SERIALIZED_CONTEXT**: The entire context, serialized.

B.8. Archiving

Because there are entries in multiple tables every time a batch job is run, it is common to create an archive strategy for the metadata tables. The tables themselves are designed to show a record of what happened in the past and generally do not affect the run of any job, with a few notable exceptions pertaining to restart:

- The framework uses the metadata tables to determine whether a particular `JobInstance` has been run before. If it has been run and if the job is not restartable, then an exception is thrown.
- If an entry for a `JobInstance` is removed without having completed successfully, the framework thinks that the job is new rather than a restart.
- If a job is restarted, the framework uses any data that has been persisted to the `ExecutionContext` to restore the `Job`'s state. Therefore, removing any entries from this table for jobs that have not completed successfully prevents them from starting at the correct point if run again.

B.9. International and Multi-byte Characters

If you are using multi-byte character sets (such as Chinese or Cyrillic) in your business processing, then those characters might need to be persisted in the Spring Batch schema. Many users find that simply changing the schema to double the length of the `VARCHAR` columns is enough. Others prefer to configure the `JobRepository` with `max-varchar-length` half the value of the `VARCHAR` column length. Some users have also reported that they use `NVARCHAR` in place of `VARCHAR` in their schema definitions. The best result depends on the database platform and the way the database server has been configured locally.

B.10. Recommendations for Indexing Meta Data Tables

Spring Batch provides DDL samples for the metadata tables in the core jar file for several common database platforms. Index declarations are not included in that DDL, because there are too many variations in how users may want to index, depending on their precise platform, local conventions, and the business requirements of how the jobs are operated. The following below provides some indication as to which columns are going to be used in a `WHERE` clause by the DAO implementations provided by Spring Batch and how frequently they might be used, so that individual projects can make up their own minds about indexing:

Table 21. Where clauses in SQL statements (excluding primary keys) and their approximate frequency of use.

Default Table Name	Where Clause	Frequency
<code>BATCH_JOB_INSTANCE</code>	<code>JOB_NAME = ? and JOB_KEY = ?</code>	Every time a job is launched
<code>BATCH_JOB_EXECUTION</code>	<code>JOB_INSTANCE_ID = ?</code>	Every time a job is restarted
<code>BATCH_STEP_EXECUTION</code>	<code>VERSION = ?</code>	On commit interval, a.k.a. chunk (and at start and end of step)
<code>BATCH_STEP_EXECUTION</code>	<code>STEP_NAME = ? and JOB_EXECUTION_ID = ?</code>	Before each step execution

Appendix C: Batch Processing and Transactions

C.1. Simple Batching with No Retry

Consider the following simple example of a nested batch with no retries. It shows a common scenario for batch processing: An input source is processed until exhausted, and we commit periodically at the end of a "chunk" of processing.

```
1 | REPEAT(until=exhausted) {  
|  
2 |   TX {  
3 |     REPEAT(size=5) {  
3.1 |       input;  
3.2 |       output;  
|     }  
|   }  
| }  
| }
```

The input operation (3.1) could be a message-based receive (such as from JMS), or a file-based read, but to recover and continue processing with a chance of completing the whole job, it must be transactional. The same applies to the operation at 3.2. It must be either transactional or idempotent.

If the chunk at **REPEAT** (3) fails because of a database exception at 3.2, then **TX** (2) must roll back the whole chunk.

C.2. Simple Stateless Retry

It is also useful to use a retry for an operation which is not transactional, such as a call to a web-service or other remote resource, as shown in the following example:

```
0 | TX {  
1 |   input;  
1.1 |   output;  
2 |   RETRY {  
2.1 |     remote access;  
|   }  
| }
```

This is actually one of the most useful applications of a retry, since a remote call is much more likely to fail and be retryable than a database update. As long as the remote access (2.1) eventually succeeds, the transaction, **TX** (0), commits. If the remote access (2.1) eventually fails, then the transaction, **TX** (0), is guaranteed to roll back.

C.3. Typical Repeat-Retry Pattern

The most typical batch processing pattern is to add a retry to the inner block of the chunk, as shown in the following example:

```
1 | REPEAT(until=exhausted, exception=not critical) {
  |
2 |   TX {
3 |     REPEAT(size=5) {
  |
4 |       RETRY(stateful, exception=deadlock loser) {
4.1 |         input;
5 |       } PROCESS {
5.1 |         output;
6 |       } SKIP and RECOVER {
  |         notify;
  |       }
  |     }
  |   }
  | }
  | }
```

The inner **RETRY** (4) block is marked as "stateful". See [the typical use case](#) for a description of a stateful retry. This means that if the retry **PROCESS** (5) block fails, the behavior of the **RETRY** (4) is as follows:

1. Throw an exception, rolling back the transaction, **TX** (2), at the chunk level, and allowing the item to be re-presented to the input queue.
2. When the item re-appears, it might be retried depending on the retry policy in place, executing **PROCESS** (5) again. The second and subsequent attempts might fail again and re-throw the exception.
3. Eventually, the item reappears for the final time. The retry policy disallows another attempt, so **PROCESS** (5) is never executed. In this case, we follow the **RECOVER** (6) path, effectively "skipping" the item that was received and is being processed.

Note that the notation used for the **RETRY** (4) in the plan above explicitly shows that the input step (4.1) is part of the retry. It also makes clear that there are two alternate paths for processing: the normal case, as denoted by **PROCESS** (5), and the recovery path, as denoted in a separate block by **RECOVER** (6). The two alternate paths are completely distinct. Only one is ever taken in normal circumstances.

In special cases (such as a special `TransactionValidException` type), the retry policy might be able to determine that the **RECOVER** (6) path can be taken on the last attempt after **PROCESS** (5) has just failed, instead of waiting for the item to be re-presented. This is not the default behavior, because it requires detailed knowledge of what has happened inside the **PROCESS** (5) block, which is not usually available. For example, if the output included write access before the failure, then the exception

should be re-thrown to ensure transactional integrity.

The completion policy in the outer **REPEAT** (1) is crucial to the success of the above plan. If the output (5.1) fails, it may throw an exception (it usually does, as described), in which case the transaction, **TX** (2), fails, and the exception could propagate up through the outer batch **REPEAT** (1). We do not want the whole batch to stop, because the **RETRY** (4) might still be successful if we try again, so we add **exception=not critical** to the outer **REPEAT** (1).

Note, however, that if the **TX** (2) fails and we *do* try again, by virtue of the outer completion policy, the item that is next processed in the inner **REPEAT** (3) is not guaranteed to be the one that just failed. It might be, but it depends on the implementation of the input (4.1). Thus, the output (5.1) might fail again on either a new item or the old one. The client of the batch should not assume that each **RETRY** (4) attempt is going to process the same items as the last one that failed. For example, if the termination policy for **REPEAT** (1) is to fail after 10 attempts, it fails after 10 consecutive attempts but not necessarily at the same item. This is consistent with the overall retry strategy. The inner **RETRY** (4) is aware of the history of each item and can decide whether or not to have another attempt at it.

C.4. Asynchronous Chunk Processing

The inner batches or chunks in the [typical example](#) can be executed concurrently by configuring the outer batch to use an **AsyncTaskExecutor**. The outer batch waits for all the chunks to complete before completing. The following example shows asynchronous chunk processing:

```
1 | REPEAT(until=exhausted, concurrent, exception=not critical) {
  |
2 |   TX {
3 |     REPEAT(size=5) {
  |
4 |       RETRY(stateful, exception=deadlock loser) {
4.1 |         input;
5 |         } PROCESS {
  |         output;
6 |         } RECOVER {
  |         recover;
  |       }
  |
  |     }
  |
  |   }
  |
  | }
```

C.5. Asynchronous Item Processing

The individual items in chunks in the [typical example](#) can also, in principle, be processed concurrently. In this case, the transaction boundary has to move to the level of the individual item, so that each transaction is on a single thread, as shown in the following example:

```

1 | REPEAT(until=exhausted, exception=not critical) {
|
2 |   REPEAT(size=5, concurrent) {
|
3 |     TX {
4 |       RETRY(stateful, exception=deadlock loser) {
4.1 |         input;
5 |       } PROCESS {
|         output;
6 |       } RECOVER {
|         recover;
|     }
|   }
| }
| }

```

This plan sacrifices the optimization benefit, which the simple plan had, of having all the transactional resources chunked together. It is only useful if the cost of the processing (5) is much higher than the cost of transaction management (3).

C.6. Interactions Between Batching and Transaction Propagation

There is a tighter coupling between batch-retry and transaction management than we would ideally like. In particular, a stateless retry cannot be used to retry database operations with a transaction manager that does not support NESTED propagation.

The following example uses retry without repeat:

```

1 | TX {
|
1.1 |   input;
2.2 |   database access;
2 |   RETRY {
3 |     TX {
3.1 |       database access;
|     }
|   }
| }
| }

```

Again, and for the same reason, the inner transaction, **TX** (3), can cause the outer transaction, **TX** (1), to fail, even if the **RETRY** (2) is eventually successful.

Unfortunately, the same effect percolates from the retry block up to the surrounding repeat batch if

there is one, as shown in the following example:

```
1 | TX {
  |
2 |   REPEAT(size=5) {
2.1 |     input;
2.2 |     database access;
3 |     RETRY {
4 |       TX {
4.1 |         database access;
  |       }
  |     }
  |   }
  | }
  | }
```

Now, if TX (3) rolls back, it can pollute the whole batch at TX (1) and force it to roll back at the end.

What about non-default propagation?

- In the preceding example, `PROPAGATION_REQUIRES_NEW` at TX (3) prevents the outer TX (1) from being polluted if both transactions are eventually successful. But if TX (3) commits and TX (1) rolls back, then TX (3) stays committed, so we violate the transaction contract for TX (1). If TX (3) rolls back, TX (1) does not necessarily (but it probably does in practice, because the retry throws a roll back exception).
- `PROPAGATION_NESTED` at TX (3) works as we require in the retry case (and for a batch with skips): TX (3) can commit but subsequently be rolled back by the outer transaction, TX (1). If TX (3) rolls back, TX (1) rolls back in practice. This option is only available on some platforms, not including Hibernate or JTA, but it is the only one that consistently works.

Consequently, the `NESTED` pattern is best if the retry block contains any database access.

C.7. Special Case: Transactions with Orthogonal Resources

Default propagation is always OK for simple cases where there are no nested database transactions. Consider the following example, where the `SESSION` and `TX` are not global `XA` resources, so their resources are orthogonal:

```

0 | SESSION {
1 |   input;
2 |   RETRY {
3 |     TX {
3.1 |       database access;
   |     }
   |   }
   | }

```

Here there is a transactional message `SESSION` (0), but it does not participate in other transactions with `PlatformTransactionManager`, so it does not propagate when `TX` (3) starts. There is no database access outside the `RETRY` (2) block. If `TX` (3) fails and then eventually succeeds on a retry, `SESSION` (0) can commit (independently of a `TX` block). This is similar to the vanilla "best-efforts-one-phase-commit" scenario. The worst that can happen is a duplicate message when the `RETRY` (2) succeeds and the `SESSION` (0) cannot commit (for example, because the message system is unavailable).

C.8. Stateless Retry Cannot Recover

The distinction between a stateless and a stateful retry in the typical example above is important. It is actually ultimately a transactional constraint that forces the distinction, and this constraint also makes it obvious why the distinction exists.

We start with the observation that there is no way to skip an item that failed and successfully commit the rest of the chunk unless we wrap the item processing in a transaction. Consequently, we simplify the typical batch execution plan to be as follows:

```

0 | REPEAT(until=exhausted) {
  |
1 |   TX {
2 |     REPEAT(size=5) {
  |
3 |       RETRY(stateless) {
4 |         TX {
4.1 |           input;
4.2 |           database access;
   |         }
5 |       } RECOVER {
5.1 |         skip;
   |       }
   |     }
   |   }
   | }

```

The preceding example shows a stateless `RETRY` (3) with a `RECOVER` (5) path that kicks in after the final attempt fails. The `stateless` label means that the block is repeated without re-throwing any

exception up to some limit. This only works if the transaction, TX (4), has propagation NESTED.

If the inner TX (4) has default propagation properties and rolls back, it pollutes the outer TX (1). The inner transaction is assumed by the transaction manager to have corrupted the transactional resource, so it cannot be used again.

Support for NESTED propagation is sufficiently rare that we choose not to support recovery with stateless retries in the current versions of Spring Batch. The same effect can always be achieved (at the expense of repeating more processing) by using the typical pattern above.

Appendix D: Glossary

D.1. Spring Batch Glossary

Batch

An accumulation of business transactions over time.

Batch Application Style

Term used to designate batch as an application style in its own right, similar to online, Web, or SOA. It has standard elements of input, validation, transformation of information to business model, business processing, and output. In addition, it requires monitoring at a macro level.

Batch Processing

The handling of a batch of many business transactions that have accumulated over a period of time (such as an hour, a day, a week, a month, or a year). It is the application of a process or set of processes to many data entities or objects in a repetitive and predictable fashion with either no manual element or a separate manual element for error processing.

Batch Window

The time frame within which a batch job must complete. This can be constrained by other systems coming online, other dependent jobs needing to execute, or other factors specific to the batch environment.

Step

The main batch task or unit of work. It initializes the business logic and controls the transaction environment, based on commit interval setting and other factors.

Tasklet

A component created by an application developer to process the business logic for a Step.

Batch Job Type

Job types describe application of jobs for particular types of processing. Common areas are interface processing (typically flat files), forms processing (either for online PDF generation or print formats), and report processing.

Driving Query

A driving query identifies the set of work for a job to do. The job then breaks that work into individual units of work. For instance, a driving query might be to identify all financial transactions that have a status of "pending transmission" and send them to a partner system. The driving query returns a set of record IDs to process. Each record ID then becomes a unit of work. A driving query may involve a join (if the criteria for selection falls across two or more tables) or it may work with a single table.

Item

An item represents the smallest amount of complete data for processing. In the simplest terms, this might be a line in a file, a row in a database table, or a particular element in an XML file.

Logical Unit of Work (LUW)

A batch job iterates through a driving query (or other input source, such as a file) to perform the set of work that the job must accomplish. Each iteration of work performed is a unit of work.

Commit Interval

A set of LUWs processed within a single transaction.

Partitioning

Splitting a job into multiple threads where each thread is responsible for a subset of the overall data to be processed. The threads of execution may be within the same JVM or they may span JVMs in a clustered environment that supports workload balancing.

Staging Table

A table that holds temporary data while it is being processed.

Restartable

A job that can be executed again and assumes the same identity as when run initially. In other words, it has the same job instance ID.

Rerunnable

A job that is restartable and manages its own state in terms of the previous run's record processing. An example of a rerunnable step is one based on a driving query. If the driving query can be formed so that it limits the processed rows when the job is restarted, then it is rerunnable. This is managed by the application logic. Often, a condition is added to the **where** statement to limit the rows returned by the driving query with logic resembling "and processedFlag!= true".

Repeat

One of the most basic units of batch processing, it defines by repeatability calling a portion of code until it is finished and while there is no error. Typically, a batch process would be repeatable as long as there is input.

Retry

Simplifies the execution of operations with retry semantics most frequently associated with handling transactional output exceptions. Retry is slightly different from repeat, rather than continually calling a block of code, retry is stateful and continually calls the same block of code with the same input, until it either succeeds or some type of retry limit has been exceeded. It is only generally useful when a subsequent invocation of the operation might succeed because something in the environment has improved.

Recover

Recover operations handle an exception in such a way that a repeat process is able to continue.

Skip

Skip is a recovery strategy often used on file input sources as the strategy for ignoring bad input records that failed validation.