



Spring XD Guide

1.2.0.M1

Mark Fisher , Mark Pollack , David Turanski , Gunnar Hillert , Eric Bottard , Patrick Peralta, Gary Russell ,
Ilayaperumal Gopinathan , Jennifer Hickey , Michael Minella , Luke Taylor , Thomas Risberg , Glenn
Renfro , Janne Valkealahti , Thomas Darimont , Dave Syer , Jon Brisbin , Andy Clement , Marius Bogoevici

Copyright © 2013-2015 Pivotal Software Inc.

Table of Contents

I. Reference Guide	1
1. Introduction	2
1.1. Overview	2
2. Getting Started	3
2.1. Requirements	3
2.2. Download Spring XD	3
2.3. Install Spring XD	3
2.4. Start the Runtime and the XD Shell	3
2.5. Create a Stream	4
2.6. Explore Spring XD	5
2.7. OSX Homebrew installation	5
2.8. RedHat/CentOS Installation	5
2.9. Running in Distributed Mode	5
Introduction	5
XD CommandLine Options	6
Setting up a RDBMS	7
Setting up ZooKeeper	8
Setting up Redis	9
Installing Redis	9
Troubleshooting	9
Starting Redis	10
Using RabbitMQ	10
Installing RabbitMQ	10
Launching RabbitMQ	10
Starting Spring XD in Distributed Mode	11
Choosing a Transport	11
Choosing an Analytics provider	11
Other Options	12
Using Hadoop	12
XD-Shell in Distributed Mode	12
2.10. Running on YARN	13
Introduction	13
What do you need?	13
Download Spring XD on YARN binaries	13
Configure your deployment	13
XD options	14
Hadoop settings	14
Zookeeper settings	14
Transport options	15
JDBC datasource properties	15
XD Admin port	15
Customizing module configurations	15
Adding custom modules	16
Modify container logging	16
Control XD YARN application lifecycle	16
Push the Spring XD application binaries and config to HDFS	16
List installed application versions	16

Submit the Spring XD YARN application	16
Check the status of YARN apps	16
Kill application	17
Using a built-in shell	17
Connect xd-shell to YARN runtime managed admins	17
Configuring YARN memory reservations	17
Working with container groups	19
List existing groups	19
Get status of a group	19
Control group state	20
Modify group configuration	20
Create a new group	21
Destroy a group	21
Built-in group configurations	22
Configuration examples	22
Run containers on a specific hosts	23
Run admins on a specific racks	23
Disable default admin and container groups	23
xd-yarn command synopsis	23
Introduction to YARN resource allocation	26
3. Application Configuration	27
3.1. Introduction	27
3.2. Server Configuration	27
Profile support	27
Database Configuration	28
HSQLDB	28
MySQL	29
PostgreSQL	29
Redis	29
RabbitMQ	30
Kafka	31
Management Port	32
Admin Server Security	33
Enabling HTTPS	33
Enabling authentication	33
Customizing authorization	36
Local transport	38
3.3. Module Configuration	38
Profiles	39
Batch Jobs or modules accessing JDBC	40
4. DSL Guide	41
4.1. Introduction	41
4.2. Pipes and filters	41
4.3. Module parameters	41
4.4. Named channels	41
4.5. Labels	42
4.6. Single quotes, Double quotes, Escaping	42
Spring Shell	43
XD Syntax	43
SpEL syntax and SpEL literals	44

Putting it all together	44
4.7. Introduction	45
Using the Shell	45
Tab completion for Job and Stream DSL definitions	47
Executing a script	47
Single quotes, Double quotes, Escaping	48
5. Admin UI	49
5.1. Introduction	49
5.2. Containers	49
5.3. Streams	50
5.4. Jobs	51
Modules	51
List available batch job modules	51
Create a Job Definition from a selected Job Module	52
View Job Module Details	53
List job definitions	53
List job deployments	54
Launching a batch Job	55
Schedule Batch Job Execution	57
Job Deployment Details	57
List job executions	58
Job execution details	60
Step execution details	61
Step execution history	63
6. Architecture	64
6.1. Introduction	64
Runtime Architecture	64
DIRT Runtime	64
Support for other distributed runtimes	65
Single Node Runtime	65
Admin Server Architecture	66
Container Server Architecture	66
Streams	67
Stream Deployment	69
6.2. Jobs	73
6.3. Taps	73
7. Distributed Runtime	74
7.1. Introduction	74
7.2. Configuring Spring XD for High Availability(HA)	74
7.3. ZooKeeper Overview	74
7.4. The Admin Server Internals	77
Example	78
7.5. Module Deployment	81
Example: Automatic Redeployment	82
8. Batch Jobs	84
8.1. Introduction	84
8.2. Workflow	84
8.3. Features	85
8.4. The Lifecycle of a Job in Spring XD	86
Register a Job Module	86

Create a Job Definition	86
Deploy the Job	86
Launch a Job	86
Job Execution	86
Un-deploy a Job	86
Destroy a Job Definition	86
Creating Jobs - Additional Options	87
8.5. Deployment manifest support for job	87
8.6. Launching a job	88
Ad-hoc	88
Launch the Batch using Cron-Trigger	88
Launch the Batch using a Fixed-Delay-Trigger	89
Launch job as a part of event flow	89
8.7. Retrieve job notifications	89
To receive aggregated events	89
To receive job execution events	90
To receive step execution events	90
To receive item, skip and chunk events	91
To disable the default listeners	91
To select specific listeners	91
8.8. Removing Batch Jobs	91
8.9. Pre-Packaged Batch Jobs	91
Note regarding HDFS Configuration	91
Poll a Directory and Import CSV Files to HDFS (<code>filepollhdfs</code>)	92
Import CSV Files to JDBC (<code>filejdbc</code>)	92
HDFS to JDBC Export (<code>hdfsjdbc</code>)	95
JDBC to HDFS Import (<code>jdbc_hdfs</code>)	98
HDFS to MongoDB Export (<code>hdfsmongodb</code>)	102
FTP to HDFS Export (<code>ftphdfs</code>)	103
Running Spark Application as a batch job (<code>sparkapp</code>)	103
Running Sqoop as a batch job (<code>sqoop</code>)	104
Running gpload as a batch job (<code>gpload</code>)	106
9. Streams	109
9.1. Introduction	109
9.2. Creating a Simple Stream	109
9.3. Deleting a Stream	110
9.4. Deploying and Undeploying Streams	110
9.5. Other Source and Sink Types	110
9.6. Simple Stream Processing	111
9.7. DSL Syntax	111
9.8. Advanced Features	111
9.9. Module Labels	112
10. Modules	113
10.1. Introduction	113
10.2. Creating a Module	113
Stream Modules	113
Module Packaging	114
Creating a Module Project	115
Configuring your Maven build	115
Configuring your Gradle build	115

Testing a Module Project	117
10.3. Registering a Module	118
The Module Registry	118
Custom Module Registry	119
10.4. Module Class Loading	119
Dynamic Module ClassLoader	119
10.5. Module Options	120
Placeholders available to all modules	122
How module options are resolved	123
10.6. Composing Modules	124
Working with Composite Modules	124
10.7. Getting Information about Modules	126
11. Sources	128
11.1. Introduction	128
11.2. HTTP	129
HTTP with options	129
11.3. SFTP	130
Options	130
11.4. Tail	131
Tail with options	131
Tail Status Events	132
11.5. File	132
File with options	132
11.6. Mail	133
11.7. Twitter Search	134
11.8. Twitter Stream	135
11.9. GemFire Source	136
Options	136
Example	137
Launching the XD GemFire Server	138
11.10. GemFire Continuous Query	138
Options	138
11.11. Syslog	139
11.12. TCP	140
TCP with options	141
Available Decoders	141
Examples	142
Binary Data Example	143
11.13. TCP Client	143
TCP Client options	143
Implementing a simple conversation	144
11.14. Reactor IP	145
11.15. RabbitMQ	145
RabbitMQ with Options	146
A Note About Retry	147
11.16. JMS	148
JMS with Options	148
11.17. Time	149
11.18. MQTT	149
Options	150

11.19. Stdout Capture	150
11.20. Kafka	151
11.21. JDBC Source	153
11.22. MongoDB Source	155
11.23. Trigger Source	156
12. Processors	158
12.1. Introduction	158
12.2. Filter	158
Filter with SpEL expression	158
Filter using jsonPath evaluation	159
Filter with Groovy Script	159
12.3. Transform	160
Transform with SpEL expression	161
Transform with Groovy Script	161
12.4. Script	161
12.5. Splitter	162
Extract the value of a specific field	162
12.6. Aggregator	163
12.7. HTTP Client	164
13. Shell	166
13.1. JSON to Tuple	167
13.2. Object to JSON	168
14. Sinks	169
14.1. Introduction	169
14.2. Log	169
14.3. File Sink	170
File with Options	171
14.4. Hadoop (HDFS)	171
HDFS with Options	176
Partition Path Expression	177
Accessing Properties	177
Custom Methods	177
14.5. HDFS Dataset (Avro/Parquet)	179
HDFS Dataset with Options	180
About null values	181
About partitionPath	181
14.6. JDBC	182
JDBC with Options	183
14.7. TCP Sink	185
TCP with Options	185
Available Encoders	186
An Additional Example	187
14.8. Shell Sink	187
14.9. Mongo	188
14.10. Mail	189
14.11. RabbitMQ	190
RabbitMQ with Options	190
14.12. GemFire Server	191
Launching the XD GemFire Server	192
Gemfire sinks	192

Example	193
14.13. Splunk Server	193
Splunk sinks	194
How To Setup Splunk for TCP Input	194
Example	194
14.14. MQTT Sink	194
Options	194
14.15. Dynamic Router	195
SpEL-based Routing	195
Groovy-based Routing	196
Options	197
14.16. Null Sink	197
14.17. Redis	198
Options	198
14.18. Kafka Sink	199
15. Taps	201
15.1. Introduction	201
Example	201
Example - tap after a processor has been applied	201
Example - using a label	201
15.2. Tap Lifecycle	202
16. Analytics	203
16.1. Introduction	203
16.2. Predictive analytics	203
16.3. Analytical Models	204
Modeling and Evaluation	204
Modeling	204
Evaluation	207
Model Selection	208
16.4. Counters and Gauges	209
Counter	209
Field Value Counter	210
Aggregate Counter	211
Gauge	212
Simple Tap Example	212
Rich Gauge	213
Simple Tap Example	213
Stock Price Example	213
Improved Stock Price Example	214
Accessing Analytics Data over the RESTful API	215
17. Tuples	217
17.1. Introduction	217
Creating a Tuple	217
Getting Tuple values	218
Using SpEL expressions to filter a tuple	219
Gradle Dependencies	220
18. Type Conversion	221
18.1. Introduction	221
18.2. MIME types	221
18.3. Stream Definition Examples	221

18.4. POJO to JSON	221
JSON to Tuple	222
Java Serialization	222
18.5. MIME types and Java types	222
Caveats	223
II. Developing Modules and Extensions	224
19. Creating a Source Module	225
19.1. Introduction	225
19.2. Create the module Application Context file	225
19.3. Create a Module Project	226
Create a Spring Integration test	226
Create an in-container test	227
19.4. Install the Module	228
19.5. Test the source module	229
20. Creating a Data Stream Processor	230
20.1. Introduction	230
20.2. Reactor Streams	230
20.3. RxJava Streams	231
Scheduling	233
20.4. Spark streaming	234
Writing a spark streaming module	235
How this works	236
Data loss and recovery	236
Module Type Conversion	237
XD processor module examples	237
21. XD sink module example	240
22. Creating a Processor Module	243
22.1. Introduction	243
22.2. Write the Transformer Code	243
22.3. Create the module Application Context File	243
22.4. Write a Test	245
22.5. Register the Module	247
22.6. Test the custom module in the Spring XD runtime:	247
23. Creating a Sink Module	248
23.1. Introduction	248
23.2. Create the module Application Context	248
23.3. Create a module project	249
Create the Spring integration test	249
Run the test	250
Test the Module Options	250
23.4. Install the module	251
23.5. Test the module	251
24. Creating a Job Module	253
24.1. Introduction	253
24.2. Developing your Job	253
24.3. Creating a Simple Job	253
Create a Module Project	253
Create the Spring Batch Job Definition	253
Write the Tasklet	254
Package and install the Module:	256

Run the job	256
24.4. Creating a read-write processing Job	256
24.5. Orchestrating Hadoop Jobs	257
25. Creating a Python Module	258
25.1. Introduction	258
26. Providing Module Options Metadata	260
26.1. Introduction	260
26.2. Using the "Simple" approach	260
Declaring and documenting an option	260
Advertising default values	261
Exposing the option type	261
26.3. Using the "POJO" approach	261
Declaring options to the module	262
Exposing values to the context	262
Providing defaults	262
Encapsulating options	262
Using profiles	263
Using validation	263
26.4. Metadata style remarks	263
26.5. Introduction	264
26.6. Spring XD Application Contexts	264
26.7. Plugin Architecture	266
26.8. How to Add a Spring bean to the XD Container	266
26.9. Providing A new Type Converter	267
26.10. Adding a New Data Transport	269
27. Samples	270
27.1. Syslog ingestion into HDFS	270
A sample configuration using syslog-ng	270
III. Configuration Guidelines	272
28. Overview	273
29. Deployment	274
29.1. Introduction	274
29.2. Deployment Manifest	274
Deployment Properties	275
General Properties	275
Bus Properties	276
Stream Partitioning	278
Direct Binding	278
29.3. Deployment States	280
Example	281
29.4. Container Attributes	281
Groups	281
IP Address	281
Hostname	282
29.5. Stream Deployment Examples	282
29.6. Partitioned Stream Deployment Examples	283
Using SpEL Expressions	283
29.7. Direct Binding Deployment Examples	284
29.8. Troubleshooting	285
ZooKeeper disconnects	285

Debugging Slowness	286
File Descriptors and limit violation	286
30. Message Bus Configuration	287
30.1. Introduction	287
30.2. Rabbit Message Bus High Availability (HA) Configuration	287
30.3. Error Handling (Message Delivery Failures)	287
RabbitMQ Message Bus	287
Redis Message Bus	288
30.4. Rabbit Message Bus Secure Sockets Layer (SSL)	289
30.5. Rabbit Message Bus Batching and Compression	290
IV. Administration	291
31. Monitoring and Management	292
31.1. Monitoring XD Admin, Container and Single-node servers	292
To enable boot provided management endpoints over HTTP	292
To enable the container shutdown operation in the UI	292
To disable boot endpoints over HTTP	292
31.2. Management over JMX	292
To disable management over JMX	293
Monitoring deployed modules in XD container	293
Streams	293
Jobs	293
31.3. Using Jolokia to access JMX over http	293
32. REST API	294
32.1. Introduction	294
32.2. XD Resources	294
32.3. Stream Definitions	295
32.4. Stream Deployments	295
32.5. Job Definitions	296
32.6. Job Deployments	296
32.7. Batch Job Configurations	296
32.8. Batch Job Executions	297
32.9. Batch Job Instances	297
32.10. Module Definitions	298
32.11. Deployed Modules	298
32.12. Containers	298
32.13. Counters	299
32.14. Field Value Counters	299
32.15. Aggregate Counters	299
32.16. Gauges	299
32.17. Rich Gauges	300
32.18. Tab Completions	300
33. JAVA API	301
33.1. Introduction	301
Required Libraries	301
Sample Usage	301
V. Appendices	302
A. Installing Hadoop	303
A.1. Installing Hadoop	303
Download	303
Java Setup	303

Setup SSH	304
Setting the Namenode Port	304
Further Configuration File Changes	305
A.2. Running Hadoop	305
B. Building Spring XD	307
B.1. Instructions	307
B.2. IDE support	307
C. Using MQTT Modules	308
C.1. Introduction	308
Setting up MQTT on RabbitMQ	308
Rabbit MQTT Plugin settings	309
MQTT Source	309
Example 1: Using defaults	309
Example 2: Monitoring different topics.	310
MQTT Sink	310
Example 1: Using defaults	310
D. XD Shell Command Reference	312
D.1. Configuration Commands	312
admin config info	312
admin config server	312
admin config timezone list	312
admin config timezone set	312
D.2. Runtime Commands	312
runtime containers	312
runtime modules	313
D.3. Stream Commands	313
stream all destroy	313
stream all undeploy	313
stream create	313
stream deploy	313
stream destroy	314
stream list	314
stream undeploy	314
D.4. Job Commands	314
job all destroy	314
job all undeploy	314
job create	314
job deploy	315
job destroy	315
job execution all stop	315
job execution display	315
job execution list	315
job execution restart	316
job execution step display	316
job execution step list	316
job execution step progress	316
job execution stop	316
job instance display	316
job launch	317
job list	317

job undeploy	317
D.5. Module Commands	317
module compose	317
module delete	317
module info	318
module list	318
module upload	318
D.6. Metrics Commands	318
counter delete	318
counter display	319
counter list	319
field-value-counter delete	319
field-value-counter display	319
field-value-counter list	319
aggregate-counter delete	319
aggregate-counter display	320
aggregate-counter list	320
gauge delete	320
gauge display	320
gauge list	321
rich-gauge delete	321
rich-gauge display	321
rich-gauge list	321
D.7. Http Commands	321
http get	321
http post	321
D.8. Hadoop Configuration Commands	322
hadoop config fs	322
hadoop config info	322
hadoop config load	322
hadoop config props get	322
hadoop config props list	322
hadoop config props set	322
D.9. Hadoop FileSystem Commands	323
hadoop fs cat	323
hadoop fs chgrp	323
hadoop fs chmod	323
hadoop fs chown	323
hadoop fs copyFromLocal	324
hadoop fs copyMergeToLocal	324
hadoop fs copyToLocal	324
hadoop fs count	324
hadoop fs cp	325
hadoop fs du	325
hadoop fs expunge	325
hadoop fs get	325
hadoop fs ls	326
hadoop fs mkdir	326
hadoop fs moveFromLocal	326
hadoop fs mv	326

hadoop fs put	326
hadoop fs rm	327
hadoop fs setrep	327
hadoop fs tail	327
hadoop fs text	327
hadoop fs touchz	328
D.10. Connecting to Kerberized Hadoop	328
Setting Principals	328
Automatic Login	328
E. Modules-Project-Migration	329
E.1. Introduction	329
Updating your Maven Project	329
Cleaning up	329
Updating your POM file	329
Updating your Gradle Project	331
Building the Module Project	333
Maven	333
Gradle	333
Updating Configurations	333
Registering the module	334

Part I. Reference Guide

1. Introduction

1.1 Overview

Spring XD is a unified, distributed, and extensible service for data ingestion, real time analytics, batch processing, and data export. The Spring XD project is an open source [Apache 2 License](#) licenced project whose goal is to tackle big data complexity. Much of the complexity in building real-world big data applications is related to integrating many disparate systems into one cohesive solution across a range of use-cases. Common use-cases encountered in creating a comprehensive big data solution are

- High throughput distributed data ingestion from a variety of input sources into big data store such as HDFS or Splunk
- Real-time analytics at ingestion time, e.g. gathering metrics and counting values.
- Workflow management via batch jobs. The jobs combine interactions with standard enterprise systems (e.g. RDBMS) as well as Hadoop operations (e.g. MapReduce, HDFS, Pig, Hive or HBase).
- High throughput data export, e.g. from HDFS to a RDBMS or NoSQL database.

The Spring XD project aims to provide a one stop shop solution for these use-cases.

2. Getting Started

2.1 Requirements

To get started, make sure your system has as a minimum [Java JDK 7](#) or newer installed. **Java JDK 7** is recommended.

2.2 Download Spring XD

To download the current release, you can download the distribution [spring-xd-1.1.2.RELEASE-dist.zip](#) and [its accompanying documentation](#).

If you want to try out the latest build of Spring XD, You can download the snapshot distribution from [the spring snapshots repository](#). You can also [build the project from source](#) if you wish. The wiki content should also be kept up to date with the current snapshot so if you are reading this on the github website, things may have changed since the last stable release.

Unzip the distribution which will unpack to a single installation directory. All the commands below are executed from this directory, so change into it before proceeding.

```
$ cd spring-xd-1.2.0.M1
```

2.3 Install Spring XD

Spring XD can be run in two different modes. There's a single-node runtime option for testing and development, and there's a distributed runtime which supports distribution of processing tasks across multiple nodes. This document will get you up and running quickly with a single-node runtime. See [Running Distributed Mode](#) for details on setting up a distributed runtime.

You can also install Spring XD using [homebrew](#) on OSX and [RPM](#) on RedHat/CentOS.

2.4 Start the Runtime and the XD Shell

The single node option is the easiest to get started with. It runs everything you need in a single process. To start it, you just need to `cd` to the `xd` directory and run the following command

```
xd/bin>$ ./xd-singlenode
```

In a separate terminal, `cd` into the `shell` directory and start the XD shell, which you can use to issue commands.

```
shell/bin>$ ./xd-shell

  _____          _____
 / ____|          | |          \ \ / /   _   |
 \  ___/          | |          \ V /| | | |
  _  /           _ \ | |          / ^ \| | | |
 /___/           / __ \| | |       /  ^ \| | | |
 \___/          /_/  \_\|_|         \_/  \_\|_|_|

  | |
  | |
  |_|

eXtreme Data
1.2.0.M1 | Admin Server Target: http://localhost:9393
Welcome to the Spring XD shell. For assistance hit TAB or type "help".
xd:>
```

The shell is a more user-friendly front end to the REST API which Spring XD exposes to clients. The URL of the currently targeted Spring XD server is shown at startup.

Note

If the server could not be reached, the prompt will read

```
server-unknown:>
```

You can then use the `admin config server <url>` to attempt to reconnect to the admin REST endpoint once you've figured out what went wrong:

```
admin config server http://localhost:9393
```

You should now be able to start using Spring XD.

Tip

Spring XD uses ZooKeeper internally which typically runs as an external process. XD `singlenode` runs with an embedded ZooKeeper server and assigns a random available port. This keeps things very simple. However if you already have a ZooKeeper ensemble set up and want to connect to it, you can edit `xd/config/servers.yml`:

```
#Zookeeper properties
# client connect string: host1:port1,host2:port2,...,hostN:portN
zk:
  client:
    connect: localhost:2181
```

Also, sometimes it is useful in troubleshooting to connect the ZooKeeper CLI to the embedded server. The assigned server port is listed in the console log, but you can also set the port directly by setting the property `zk.embedded.server.port` in `servers.yml` or set `JAVA_OPTS` before starting `xd-singlenode`.

```
$export JAVA_OPTS=-Dzk.embedded.server.port=<port>
```

2.5 Create a Stream

In Spring XD, a basic stream defines the ingestion of event driven data from a source to a sink that passes through any number of processors. You can create a new stream by issuing a `stream create` command from the XD shell. Stream definitions are built from a simple DSL. For example, execute:

```
xd> stream create --name ticktock --definition "time | log" --deploy
```

This defines a stream named `ticktock` based off the DSL expression `time | log`. The DSL uses the "pipe" symbol `|`, to connect a source to a sink. The stream server finds the `time` and `log` definitions in the modules directory and uses them to setup the stream. In this simple example, the `time` source simply sends the current time as a message each second, and the `log` sink outputs it using the logging framework at the `WARN` logging level. Since the `--deploy` flag was provided, this stream will be deployed immediately. In the console where you started the server, you will see log output similar to that listed below

```

13:09:53,812 INFO http-bio-8080-exec-1 module.SimpleModule:109 - started module: Module [name=log,
type=sink]
13:09:53,813 INFO http-bio-8080-exec-1 module.ModuleDeployer:111 - launched sink module: ticktock:log:1
13:09:53,911 INFO http-bio-8080-exec-1 module.SimpleModule:109 - started module: Module [name=time,
type=source]
13:09:53,912 INFO http-bio-8080-exec-1 module.ModuleDeployer:111 - launched source module:
ticktock:time:0
13:09:53,945 WARN task-scheduler-1 logger.ticktock:141 - 2013-06-11 13:09:53
13:09:54,948 WARN task-scheduler-1 logger.ticktock:141 - 2013-06-11 13:09:54
13:09:55,949 WARN task-scheduler-2 logger.ticktock:141 - 2013-06-11 13:09:55

```

To stop the stream, and remove the definition completely, you can use the `stream destroy` command:

```
xd:>stream destroy --name ticktock
```

It is also possible to stop and restart the stream instead, using the `undeploy` and `deploy` commands. The shell supports command completion so you can hit the `tab` key to see which commands and options are available.

2.6 Explore Spring XD

Learn about the modules available in Spring XD in the [Sources](#), [Processors](#), and [Sinks](#) sections of the documentation.

Don't see what you're looking for? Create a custom module: [source](#), [processor](#) or [sink](#) (and then consider [contributing](#) it back to Spring XD).

Want to add some analytics to your stream? Check out the [Taps](#) and [Analytics](#) sections.

2.7 OSX Homebrew installation

If you are on a Mac and using [homebrew](#), all you need to do to install *Spring XD* is:

```

$ brew tap pivotal/tap
$ brew install springxd

```

Homebrew will install `springxd` to `/usr/local/bin`. Now you can jump straight into using **Spring XD**:

```
$ xd-singlenode
```

Brew install also allows you to run *Spring XD* in distributed mode on you OSX. See [Running Distributed Mode](#) for details on setting up a distributed runtime.

2.8 RedHat/CentOS Installation

If you are using RHEL or CentOS v. 6.x you can install *Spring XD* using our RPM package. See the [wiki page](#) for instructions.

2.9 Running in Distributed Mode

Introduction

The Spring XD distributed runtime (DIRT) supports distribution of processing tasks across multiple nodes. See [Getting Started](#) for information on running Spring XD as a single node.

The XD distributed runtime architecture consists of the following distributed components:

- Admin - Manages Stream and Job deployments and other end user operations and provides REST services to access runtime state, system metrics, and analytics
- Container - Hosts deployed Modules (stream processing tasks) and batch jobs
- ZooKeeper - Provides all runtime information for the XD cluster. Tracks running containers, in which containers modules and jobs are deployed, stream definitions, deployment manifests, and the like, see [XD Distributed Runtime](#) for an overview on how XD uses ZooKeeper.
- Spring Batch Job Repository Database - An RDBMS is required for jobs. The XD distribution comes with HSQLDB, but this is not appropriate for a production installation. XD supports any JDBC compliant database.
- A Message Broker - Used for data transport. XD data transport is designed to be pluggable. Currently XD supports Rabbit MQ and Redis for messaging during stream and job processing, and Kafka for messaging during stream processing only. Please note that support for job processing using Kafka as transport is not currently available. A production installation must configure one of these transport options.
- Analytics Repository - XD currently uses Redis to store the counters and gauges provided [Analytics](#)

In addition, XD provides a Command Line Interface (CLI), XD Shell as well as a web application, XD-UI to interact with the XD runtime.

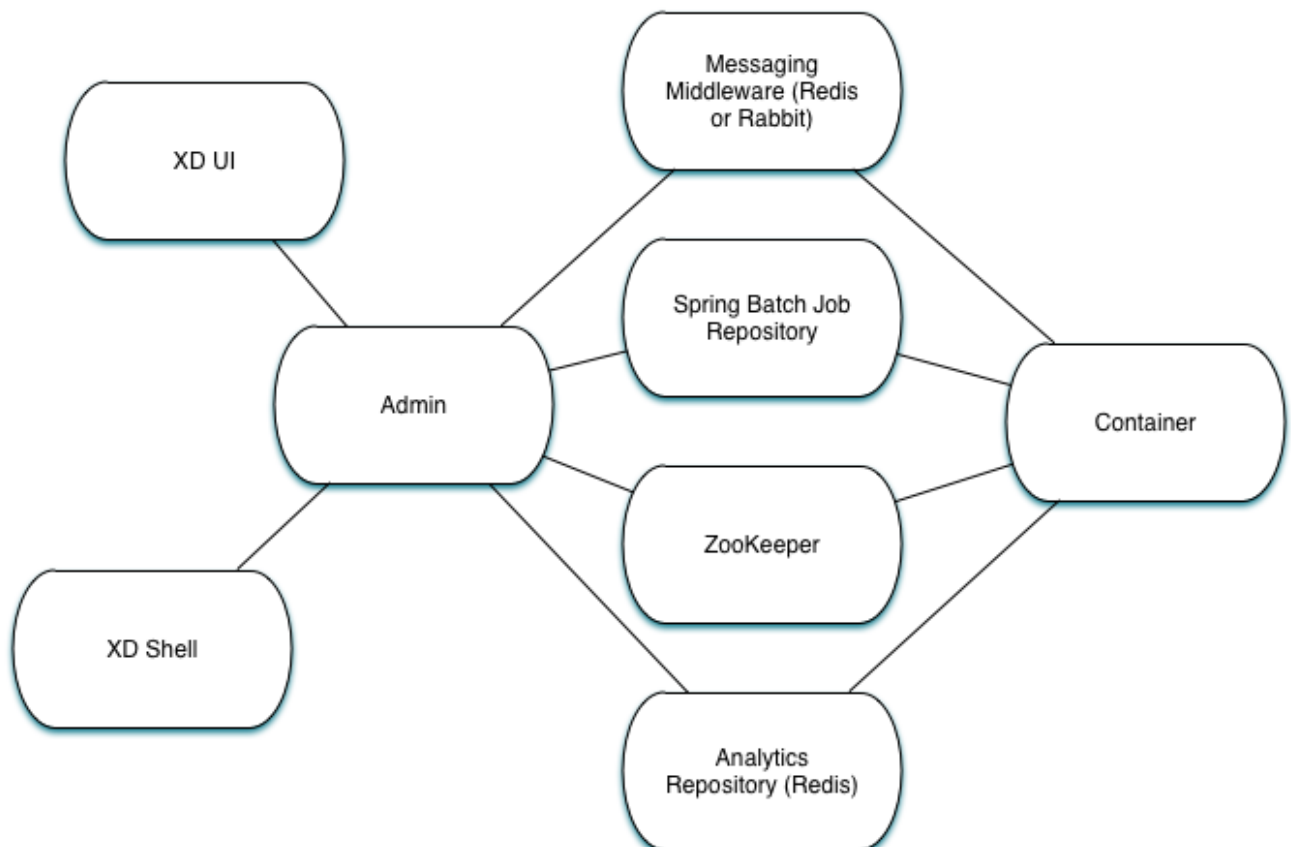

XD CommandLine Options

The XD distribution provides shell scripts to start its runtime components under the `xd` directory of the XD installation:

Whether you are running `_xd-admin`, `xd-container` or even `xd-singlenode` you can always get help by typing the command followed by `--help`. For example:

```
xd/bin/xd-admin --help

  _____
 /  _  |          (-)          \  _  |
 \  \  |  - - - - - - - - - -  \  \  |
  \  \  |  \  \  |  \  \  |  \  \  |
 /  \  |  /  \  |  /  \  |  /  \  |
 \  \  |  \  \  |  \  \  |  \  \  |
  \  \  |  \  \  |  \  \  |  \  \  |
   |  |  |  |  |  |  |  |  |  |  |
   |  |  |  |  |  |  |  |  |  |
  1.2.0.M1          eXtreme Data

Started : AdminServerApplication
Documentation: https://github.com/spring-projects/spring-xd/wiki

Usage:
--analytics [redis] : How to persist analytics such as counters and gauges
--help (-?, -h)    : Show this help screen
--httpPort <httpPort> : Http port for the REST API server
--mgmtPort <mgmtPort> : The port for the management server
```

xd-admin command line args:

- **analytics** - The data store that will be used to store the analytics data. The default is **redis**
- **help** - Displays help for the command args. Help information may be accessed with a `-?` or `-h`.
- **httpPort** - The http port for the REST API server. Defaults to 9393.
- **mgmtPort** - The port for the management server. Defaults to the admin server port.

Also, note that it is recommended to use fixed http port for XDAdmin(s). This makes it easy to know the admin server addresses the REST clients (shell, webUI) can point to. If a random port is chosen (with `server.port` or `$PORT` set to 0), then one needs to go through the log and find which port admin server's tomcat starts at.

xd-container command line args:

- **analytics** - How to persist analytics such as counters and gauges. The default is **redis**
- **groups** - The assigned group membership for this container as a comma delimited list
- **hadoopDistro** - The Hadoop distribution to be used for HDFS access. HDFS is not available if not set.
- **help** - Displays help for the command args. Help information may be accessed with a `-?` or `-h`.
- **mgmtPort** - The port for the management server. Defaults to the container server port.

Setting up a RDBMS

The distributed runtime requires an RDBMS. The XD distribution comes with an HSQLDB in memory database for testing purposes, but an alternate is expected. To start HSQLDB:

```
$ cd hsqldb/bin
$ ./hsqldb-server
```

To configure XD to connect to a different RDBMS, have a look at `xd/config/servers.yml` in the `spring:datasource` section for details. Note that `spring.batch.initializer.enabled` is set to `true` by default which will initialize the Spring Batch schema if it is not already set up. However, if those tables have already been created, they will be unaffected.

If the provided schemas are customized, other values may need to be customized. In the `xd/config/servers.yml` the following block exposes database specific values for the batch job repository.

```
spring:
  batch:
    isolationLevel:          ISOLATION_SERIALIZABLE ❶
    clobType:                ❷
    dbType:                  ❸
    maxVarcharLength:       2500                    ❹
    tablePrefix:             BATCH_                 ❺
    validateTransactionState: true                 ❻
    initializer:
      enabled:               false                  ❼
```

- ❶ Transaction isolation level for the job repository.
- ❷ A special handler for large objects. The default is usually `fine`, except for some (usually older) versions of Oracle. The default is determined from the data base type.
- ❸ Used to determine what id incremented to use. The default is usually `fine`, except when the type returned by the datasource should be overridden (GemfireXD for example).
- ❹ Configures how large the maximum message can be stored in a `VARCHAR` type field.
- ❺ Prefix for repository tables.
- ❻ Flag to determine whether to check for an existing transaction when a `JobExecution` is created. Defaults to `true` because it is usually a mistake, and leads to problems with restartability and also to deadlocks in multi-threaded steps.
- ❼ Flag that indicates if the database tables should be created on startup.

Setting up ZooKeeper

Currently XD does not ship with ZooKeeper. At the time of this writing, the compliant version is 3.4.6 and you can download it from [here](#). Please refer to the [ZooKeeper Getting Started Guide](#) for more information. A ZooKeeper ensemble consisting of at least three members is recommended for production installations, but a single server is all that is needed to have XD up and running.

You can configure the root path in Zookeeper where an XD cluster's top level nodes will be created. This allows you to run multiple independent clusters of XD that share a single ZK instance. Add the following to `servers.yml` to configure. You can also set as an environment variable, system property in the standard manner.

Additionally, various time related settings may be optionally configured for ZooKeeper:

- **sessionTimeout** - session timeout in milliseconds
- **connectionTimeout** - connection timeout in milliseconds
- **initialRetryWait** - initial amount of time to wait between retries after a failed connection (uses the [Apache Curator ExponentialBackoffRetry](#))
- **retryMaxAttempts** - maximum number of times to retry after a failed connection (uses the [Apache Curator ExponentialBackoffRetry](#))

```
zk:
  namespace: xd
  client:
    connect: localhost:2181
    sessionTimeout: 60000
    connectionTimeout: 30000
    initialRetryWait: 1000
    retryMaxAttempts: 3
```

Setting up Redis

Redis is the default transport when running in distributed mode.

Installing Redis

If you already have a running instance of **Redis** it can be used for Spring XD. By default Spring XD will try to use a *Redis* instance running on **localhost** using **port 6379**. You can change that in the `servers.yml` file residing in the `config/` directory.

If you don't have a pre-existing installation of *Redis*, you can use the *Spring XD* provided instance (For Linux and Mac) which is included in the .zip download. If you are installing using brew or rpm you should install Redis using those installers or download the source tarball and compile Redis yourself. If you used the .zip download then inside the *Spring XD* installation directory (spring-xd) do:

```
$ cd redis/bin
$ ./install-redis
```

This will compile the *Redis* source tar and add the *Redis* executables under `redis/bin`:

- `redis-check-dump`
- `redis-sentinel`
- `redis-benchmark`
- `redis-cli`
- `redis-server`

You are now ready to start *Redis* by executing

```
$ ./redis-server
```

Tip

For further information on installing *Redis* in general, please checkout the [Redis Quick Start](#) guide. If you are using *Mac OS*, you can also install *Redis* via [Homebrew](#)

Troubleshooting

Redis on Windows

Presently, *Spring XD* does not ship *Windows* binaries for *Redis* (See [XD-151](#)). However, *Microsoft* [is actively working](#) on supporting *Redis* on *Windows*. You can download *Windows Redis* binaries from:

<https://github.com/Microsoft/redis/tree/2.6/bin/release>

Redis is not running

If you try to run *Spring XD* and *Redis* is NOT running, you will see the following exception:

Starting Spring XD in Distributed Mode

Spring XD consists of two servers

- XDAdmin - controls deployment of modules into containers
- XDContainer - executes modules

You can start the `xd-container` and `xd-admin` servers individually as follows:

```
xd/bin>$ ./xd-admin
xd/bin>$ ./xd-container
```

Choosing a Transport

Spring XD uses data transport for sending data from the output of one module to the input of the next module. In general, this requires remote transport between container nodes. The Admin server also uses the data bus to launch batch jobs by sending a message to the job's launch channel. Since the same transport must be shared by the Admin and all Containers, the transport configuration is centrally configured in `xd/config/servers.yml`. The default transport is `redis`. Open `servers.yml` with a text editor and you will see the transport configuration near the top. To change the transport, you can uncomment this section and change the transport to `rabbit` or any other supported transport. Any changes to the transport configuration must be replicated to every XD node in the cluster.

Note

XD `singlenode` also supports a `--transport` command line argument, useful for testing streams under alternate transports.

```
#xd:
# transport: redis
```

Note

If you have multiple XD instances running share a single RabbitMQ server for transport, you may encounter issues if each system contains streams of the same name. We recommend using a different RabbitMQ virtual host for each system. Update the `spring.rabbitmq.virtual_host` property in `$XD_HOME/config/servers.yml` to point XD at the correct virtual host.

Choosing an Analytics provider

By default, the `xd-container` will store Analytics data in `redis`. At the time of writing, this is the only supported option (when running in distributed mode). Use the `--analytics` option to specify another backing store for Analytics data.

```
xd/bin>$ ./xd-container --analytics redis
```

You can configure the following settings for `redis` analytics

```

xd:
  analytics:
    redis:
      backOffInitialInterval: 1000 ❶
      backOffMaxInterval: 10000 ❷
      backOffMultiplier: 2.0 ❸
      maxAttempts: 3 ❹

```

- ❶ The time in milliseconds before retrying a failed redis operation
- ❷ The maximum time (ms) to wait between retries
- ❸ The back off multiplier (previous interval x multiplier = next interval)
- ❹ The maximum number of retry attempts

Other Options

There are additional configuration options available for these scripts:

To specify the location of the Spring XD install other than the default configured in the script

```
export XD_HOME=<Specific XD install directory>
```

To specify the http port of the XDAdmin server,

```
xd/bin>$ ./xd-admin --httpPort <httpPort>
```

The XDContainer nodes by default start up with `server.port 0` (which means they will scan for an available HTTP port). You can disable the HTTP endpoints for the XDContainer by setting `server.port=-1`. Note that in this case HTTP source support will not work in a PaaS environment because typically it would require XD to bind to a specific port. Both the XDAdmin and XDContainer processes bind to `server.port $PORT` (i.e. an environment variable if one is available, as is typical in a PaaS).

Using Hadoop

Spring XD supports the following Hadoop distributions:

- `hadoop25` - Apache Hadoop 2.5.2
- `hadoop26` - Apache Hadoop 2.6.0 (default)
- `phd21` - Pivotal HD 2.1 and 2.0
- `phd30` - Pivotal HD 3.0
- `cdh5` - Cloudera CDH 5.3.0
- `hdp22` - Hortonworks Data Platform 2.2

To specify the distribution libraries to use for Hadoop client connections, use the option `--hadoopDistro` for the `xd-container` and `xd-shell` commands:

```

xd/bin>$ ./xd-shell --hadoopDistro <distribution>
xd/bin>$ ./xd-admin
xd/bin>$ ./xd-container --hadoopDistro <distribution>

```

Pass in the `--help` option to see other configuration properties.

XD-Shell in Distributed Mode

If you wish to use a XD-Shell that is on a different machine than where you deployed your admin server.

1) Open your shell

```
shell/bin>$ ./xd-shell
```

2) From the xd shell use the "admin config server" command i.e.

```
admin config server <yourhost>:9393
```

2.10 Running on YARN

Introduction

The Spring XD distributed runtime (DIRT) supports distribution of processing tasks across multiple nodes. See [Running Distributed Mode](#) for information on running Spring XD in distributed mode. One option is to run these nodes on a Hadoop YARN cluster rather than on VMs or physical servers managed by you.

What do you need?

To begin with, you need to have access to a Hadoop cluster running a version based on Apache Hadoop version 2. This includes [Apache Hadoop 2.6.0](#), [Pivotal HD 2.1](#), [Hortonworks HDP 2.2](#) and [Cloudera CDH5](#).

You need a supported transport, see [Running Distributed Mode](#) for installation of Redis or Rabbit MQ. Spring XD on YARN currently uses Redis as the default data transport.

You also need Zookeeper running. If your Hadoop cluster doesn't have Zookeeper installed you need to install and run it specifically for Spring XD. See the [Setting up ZooKeeper](#) section of the "Running Distributed Mode" chapter.

Lastly, you need an RDBMs to support batch jobs and JDBC operations.

Download Spring XD on YARN binaries

In addition to the regular `spring-xd-<version>-dist.zip` files we also distribute a zip file that includes all you need to deploy on YARN. The name of this zip file is `spring-xd-<version>-yarn.zip`. You can download the zip file for the current release from [Spring release repo](#) or a milestone build from the [Spring milestone repo](#). Unzip the downloaded file and you should see a `spring-xd-<version>-yarn` directory.

Configure your deployment

Configuration options are contained in a `config/servers.yml` file in the Spring XD YARN install directory. You need to configure the hadoop settings, the transport choice plus redis/rabbit settings, the zookeeper settings and the JDBC datasource properties.

Depending on the distribution used you might need to change the `siteYarnAppClasspath` and `siteMapreduceAppClasspath`. We have provided basic settings for the supported distros, you just need to uncomment the ones for the distro you use.

These are the settings used for Hadoop 2.6.0:

```
spring:
  yarn:
    siteYarnAppClasspath: "$HADOOP_CONF_DIR,$HADOOP_COMMON_HOME/share/hadoop/common/*,$HADOOP_COMMON_HOME/share/hadoop/common/lib/*,$HADOOP_HDFS_HOME/share/hadoop/hdfs/*,$HADOOP_HDFS_HOME/share/hadoop/hdfs/lib/*,$HADOOP_YARN_HOME/share/hadoop/yarn/*,$HADOOP_YARN_HOME/share/hadoop/yarn/lib*"
    siteMapreduceAppClasspath: "$HADOOP_MAPRED_HOME/share/hadoop/mapreduce/*,$HADOOP_MAPRED_HOME/share/hadoop/mapreduce/lib/*"
```

XD options

For Spring XD you need to define how many admin servers and containers you need using properties `spring.xd.adminServers` and `spring.xd.containers` respectively. You also need to define the HDFS location using property `spring.yarn.applicationDir` where the Spring XD binary and config files will be stored.

```
spring:
  xd:
    appmasterMemory: 512M
    adminServers: 1
    adminMemory: 512M
    adminLocality: false
    containers: 3
    containerMemory: 512M
    containerLocality: false
    container:
      groups: yarn
  yarn:
    applicationDir: /xd/app/
```

More about memory settings in above configuration, see section the section called “Configuring YARN memory reservations”.

Hadoop settings

You need to specify the host where the YARN Resource Manager is running using `spring.hadoop.resourceManagerHost` as well as the HDFS URL using `spring.hadoop.fsUri`.

```
# Hadoop properties
spring:
  hadoop:
    fsUri: hdfs://localhost:8020
    resourceManagerHost: localhost
  config:
    topology.script.file.name: /path/to/topology-script.sh
```

Important

Setting `hadoop.topology.script.file.name` property is mandatory if more sophisticated container placement is used to allocate XD admins or containers from a specific hosts or racks. If this property is not set to match a one used in a hadoop cluster, allocations using hosts and racks will simply fail.

Zookeeper settings

You should specify the Zookeeper connection settings

```
#Zookeeper properties
#client connect string: host1:port1,host2:port2,...,hostN:portN
zk:
  client:
    connect: localhost:2181
```

Transport options

You should choose either `redis` (default) or `rabbit` as the transport and include the host and port in the properties for the choice you made.

```
# Transport used
transport: redis
```

```
# Redis properties
spring:
  redis:
    port: 6379
    host: localhost
```

JDBC datasource properties

You should specify the JDBC connection properties based on the RDBMs that you use for the batch jobs and JDBC sink

```
#Config for use with MySQL - uncomment and edit with relevant values for your environment
spring:
  datasource:
    url: jdbc:mysql://yourDBhost:3306/yourDB
    username: yourUsername
    password: yourPassword
    driverClassName: com.mysql.jdbc.Driver
```

XD Admin port

On default the property `server.port` which defines the used port for embedded server is disabled thus falling back to default which is 8080.

```
#Port that admin-ui is listening on
#server:
# port: 9393
```

On YARN it is recommended that you simply set the port to 0 meaning server will automatically choose a random port. This is advisable simply because it will prevent port collision which are usually a little difficult to track down from a cluster. See more instructions from section the section called “Connect xd-shell to YARN runtime managed admins” how to connect xd-shell to admins managed by YARN.

```
#Port that admin-ui is listening on
server:
  port: 0
```

Customizing module configurations

The configurations for all modules can be customized by modifying the file `modules.yml` in the `config` directory and then adding it to the `modules-config.zip` archive in the same directory.

You can run the following command from the `config` directory to achieve this:

```
jar -uf modules-config.zip modules.yml
```

Adding custom modules

There is an empty archive file named `custom-modules.zip`. You can replace this with your own ZIP archive with the same name and it will be uploaded as part of the deployment to YARN. Place custom module definitions in a `modules` directory inside this new ZIP archive. Module definitions must follow the Spring XD module semantics.

Modify container logging

Logging configuration for XD admins and containers are defined in files `config/xd-admin-logger.properties` and `config/xd-container-logger.properties` respectively. These two files are copied over to hdfs during the deployment. If you want to modify logging configuration either modify source files and do a deployment again or modify files in hdfs directly.

Control XD YARN application lifecycle

Change current directory to be the directory that was unzipped `spring-xd-<version>-yarn`. To read about runtime configuration and more sophisticated features see section the section called "Working with container groups".

Push the Spring XD application binaries and config to HDFS

Run the command

```
$ bin/xd-yarn push
New version installed
```

List installed application versions

Run the command

```
$ bin/xd-yarn pushed
NAME  PATH
----  -
app   hdfs://node1:8020/xd
```

Submit the Spring XD YARN application

Run the command

```
$ bin/xd-yarn submit
New instance submitted with id application_1420911708637_0001
```

Check the status of YARN apps

You can use the regular `yarn` command to check the status. Simply run:

```
$ bin/xd-yarn submitted
APPLICATION ID          USER           NAME    QUEUE    TYPE  STARTTIME          FINISHTIME  STATE
FINALSTATUS  ORIGINAL TRACKING URL
-----
application_1420911708637_0001  jvalkealahti  xd-app  default  XD    09/01/15 14:25  N/A
RUNNING  UNDEFINED  http://172.16.101.106:49792
```

You should see one application running named `xd-app`.

Important

Pay attention to `APPLICATION_ID` listed in output because that is an `id` used in most of the control commands to communicate to a specific application instance. For example you may have multiple `XD YARN runtime` instances running.

Kill application

Application can be killed using a `kill` command.

```
$ bin/xd-yarn kill -a application_1420905836797_0001
Kill request for application_1420905836797_0001 sent
```

Using a built-in shell

To get a better and faster command usage a build-in shell can be used to run control commands:

```
$ bin/xd-yarn shell
Spring YARN Cli (v2.1.0.M3)
Hit TAB to complete. Type 'help' and hit RETURN for help, and 'exit' to quit.
$
clear          clustercreate  clusterdestroy  clusterinfo     clustermodify
clustersinfo  clusterstart   clusterstop     exit            help
kill           prompt         pushed          submit          submitted
$
```

Connect xd-shell to YARN runtime managed admins

XD admins will register its runtime information into zookeeper and you can use the `admininfo` command to query this information:

```
$ bin/xd-yarn admininfo
Admins: [http://hadoop.localdomain:43740]
```

Then connect `xd-shell` to this instance:

```
server-unknown:>admin config server http://hadoop.localdomain:43740
Successfully targeted http://hadoop.localdomain:43740

xd:>runtime containers
  Container Id          Host          IP Address      PID    Groups  Custom
  Attributes
  -----
  -----
  6324a9ae-205b-44b9-b851-f0edd7245286  node2.localdomain  172.16.101.102  12284  yarn
  {virtualCores=1, memory=512, managementPort=54694}
```

Configuring YARN memory reservations

YARN Nodemanager is continuously tracking how much memory is used by individual YARN containers. If containers are using more memory than what the configuration allows, containers are simply killed by a Nodemanager. Application master controlling the app lifecycle is given a little more freedom meaning that Nodemanager is not that aggressive when making a decision when a container should be killed.

Lets take a quick look of memory related settings in YARN cluster and in YARN applications. Below xml config is what a default vanilla Apache Hadoop uses for memory related settings. Other distributions may have different defaults.

yarn-site.xml.

```

<configuration>

  <property>
    <name>yarn.nodemanager.pmem-check-enabled</name>
    <value>true</value>
  </property>

  <property>
    <name>yarn.nodemanager.vmem-check-enabled</name>
    <value>true</value>
  </property>

  <property>
    <name>yarn.nodemanager.vmem-pmem-ratio</name>
    <value>2.1</value>
  </property>

  <property>
    <name>yarn.scheduler.minimum-allocation-mb</name>
    <value>1024</value>
  </property>

  <property>
    <name>yarn.scheduler.maximum-allocation-mb</name>
    <value>8192</value>
  </property>

  <property>
    <name>yarn.nodemanager.resource.memory-mb</name>
    <value>8192</value>
  </property>

</configuration>

```

yarn.nodemanager.pmem-check-enabled

Enables a check for physical memory of a process. This check if enabled is directly tracking amount of memory requested for a YARN container.

yarn.nodemanager.vmem-check-enabled

Enables a check for virtual memory of a process. This setting is one which is usually causing containers of a custom YARN applications to get killed by a node manager. Usually the actual ratio between physical and virtual memory is higher than a default 2.1 or bugs in a OS is causing wrong calculation of a used virtual memory.

yarn.nodemanager.vmem-pmem-ratio

Defines a ratio of allowed virtual memory compared to physical memory. This ratio simply defines how much virtual memory a process can use but the actual tracked size is always calculated from a physical memory limit.

yarn.scheduler.minimum-allocation-mb

Defines a minimum allocated memory for container.

Important

This setting also indirectly defines what is the actual physical memory limit requested during a container allocation. Actual physical memory limit is always going to be multiple of this setting rounded to upper bound. For example if this setting is left to default 1024 and container is requested with 512M, 1024M is going to be used. However if requested size is 1100M, actual size is set to 2048M.

`yarn.scheduler.maximum-allocation-mb`

Defines a maximum allocated memory for container.

`yarn.nodemanager.resource.memory-mb`

Defines how much memory a node controlled by a node manager is allowed to allocate. This setting should be set to amount of which OS is able give to YARN managed processes in a way which doesn't cause OS to swap, etc.

Tip

If testing XD YARN runtime on a single computer with a multiple VM based hadoop cluster a pro tip is to set both `yarn.nodemanager.pmem-check-enabled` and `yarn.nodemanager.vmem-check-enabled` to false, set `yarn.scheduler.minimum-allocation-mb` much lower to either 256 or 512 and `yarn.nodemanager.resource.memory-mb` 15%-20% below a defined VM memory.

We have three memory settings for components participating XD YARN runtime. You can use configuration properties `spring.xd.appmasterMemory`, `spring.xd.adminMemory` and `spring.xd.containerMemory` respectively.

```
spring:
  xd:
    appmasterMemory: 512M
    adminMemory: 512M
    containerMemory: 512M
```

Working with container groups

Container grouping and clustering is more sophisticated feature which allows better control of XD admins and containers at runtime. Basic features are:

- Control members in a groups.
- Control lifecycle state for group as whole.
- Create groups dynamically.
- Re-start failed containers.

XD YARN Runtime has a few built-in groups to get you started. There are two groups `admin` and `container` created by default which both are launching exactly one container chosen randomly from YARN cluster.

List existing groups

Run the command:

```
$ bin/xd-yarn clustersinfo -a application_1420911708637_0001
CLUSTER ID
-----
container
admin
```

Get status of a group

Run the command:

```
bin/xd-yarn clusterinfo -a application_1420911708637_0001 -c admin
CLUSTER STATE  MEMBER COUNT
-----
RUNNING        1
```

Or to get verbose output:

```
$ bin/xd-yarn clusterinfo -a application_1420911708637_0001 -c admin -v
CLUSTER STATE  MEMBER COUNT  ANY PROJECTION  HOSTS PROJECTION  RACKS PROJECTION  ANY SATISFY  HOSTS
SATISFY  RACKS SATISFY
-----
RUNNING        1            1              {}              {}              0            {}
  {}
```

Control group state

Run the commands to stop group, list its status, start group and finally list status again:

```
$ bin/xd-yarn clusterinfo -a application_1420911708637_0001 -c container
CLUSTER STATE  MEMBER COUNT
-----
RUNNING        1

$ bin/xd-yarn clusterstop -a application_1420911708637_0001 -c container
Cluster container stopped.

$ bin/xd-yarn clusterinfo -a application_1420911708637_0001 -c container
CLUSTER STATE  MEMBER COUNT
-----
STOPPED        0

$ bin/xd-yarn clusterstart -a application_1420911708637_0001 -c container
Cluster container started.

$ bin/xd-yarn clusterinfo -a application_1420911708637_0001 -c container
CLUSTER STATE  MEMBER COUNT
-----
RUNNING        1
```

Modify group configuration

In these commands we first ramp up container count and then ramp it down:

```
18:19 $ bin/xd-yarn clusterinfo -a application_1420911708637_0001 -c container
CLUSTER STATE  MEMBER COUNT
-----
RUNNING        1

$ bin/xd-yarn clustermodify -a application_1420911708637_0001 -c container -w 3
Cluster container modified.

$ bin/xd-yarn clusterinfo -a application_1420911708637_0001 -c container
CLUSTER STATE  MEMBER COUNT
-----
RUNNING        3

$ bin/xd-yarn clustermodify -a application_1420911708637_0001 -c container -w 2
Cluster container modified.

$ bin/xd-yarn clusterinfo -a application_1420911708637_0001 -c container
CLUSTER STATE  MEMBER COUNT
-----
RUNNING        2
```

Note

In above example we used option `-w` which is a shortcut for defining YARN allocation which uses a wildcard requests allowing containers to be requested from any host.

Create a new group

When you want to create a new group that is because you need to add new XD admin or container nodes to a current system with a different settings. These setting usually differ by a colocation of containers. More about built-in group configuration refer to section the section called "Built-in group configurations".

Run the command:

```
$ bin/xd-yarn clustercreate -a application_1420911708637_0001 -c custom -i container-nolocality-template
-p default -w 2
Cluster custom created.

$ bin/xd-yarn clusterinfo -a application_1420911708637_0001 -c custom
CLUSTER STATE  MEMBER COUNT
-----
INITIAL        0

$ bin/xd-yarn clusterstart -a application_1420911708637_0001 -c custom
Cluster custom started.

$ bin/xd-yarn clusterinfo -a application_1420911708637_0001 -c custom
CLUSTER STATE  MEMBER COUNT
-----
RUNNING        2
```

To create group with two containers on `node5` and one on `node6` run command:

```
$ bin/xd-yarn clustercreate -a application_1420911708637_0001 -c custom -i container-locality-template -
p default -y "{hosts:{node6: 1,node5: 2}}"
Cluster custom created.

$ bin/xd-yarn -a application_1420911708637_0001 -c custom -v
CLUSTER STATE  MEMBER COUNT  ANY PROJECTION  HOSTS PROJECTION  RACKS PROJECTION  ANY SATISFY  HOSTS
SATISFY        RACKS SATISFY
-----
INITIAL        0              0              {node5=2, node6=1}  {}              0
{node5=2, node6=1}  {}
```

Destroy a group

Run the commands:

```

$ bin/xd-yarn clustersinfo -a application_1420911708637_0001
CLUSTER ID
-----
container
admin

$ bin/xd-yarn clusterinfo -a application_1420911708637_0001 -c container
CLUSTER STATE  MEMBER COUNT
-----
RUNNING        1

$ bin/xd-yarn clusterstop -a application_1420911708637_0001 -c container
Cluster container stopped.

$ bin/xd-yarn clusterinfo -a application_1420911708637_0001 -c container
CLUSTER STATE  MEMBER COUNT
-----
STOPPED        0

$ bin/xd-yarn clusterdestroy -a application_1420911708637_0001 -c container
Cluster container destroyed.

$ bin/xd-yarn clustersinfo -a application_1420911708637_0001
CLUSTER ID
-----
admin

```

Note

Group can only destroyed if its status is STOPPED or INITIAL.

Built-in group configurations

Few groups are already defined where `admin` and `container` are enabled automatically. Other groups are disabled and thus working as a blueprints which can be used to create groups manually.

admin

Default group definition for XD admins.

container

Default group definition for XD containers.

admin-nolocality-template

Blueprint with relax localization. Use this to create a groups if you plan to use any matching.

admin-locality-template

Blueprint with no relax localization. Use this to create a groups if you plan to use hosts or racks matching.

container-nolocality-template

Blueprint with relax localization. Use this to create a groups if you plan to use any matching.

container-locality-template

Blueprint with no relax localization. Use this to create a groups if you plan to use hosts or racks matching.

Configuration examples

This section contains examples of usual use cases for custom configurations.

Run containers on a specific hosts

Below configuration sets default XD container to exist on `node1` and `node2`.

```
xd:
  containerLocality: true
spring:
  yarn:
    appmaster:
      containercluster:
        clusters:
          container:
            projection:
              data: {any: 0, hosts: {node1: 1, node2: 1}}
```

Run admins on a specific racks

Below configuration sets default XD admins to exist on `/rack1` and `/rack2`.

```
xd:
  adminLocality: true
spring:
  yarn:
    appmaster:
      containercluster:
        clusters:
          admin:
            projection:
              data: {any: 0, racks: {/rack1: 1, /rack2: 1}}
```

Disable default admin and container groups

Existing built-in groups `admin` and `container` can be disabled by setting their projection types to `null`.

```
spring:
  yarn:
    appmaster:
      containercluster:
        clusters:
          admin:
            projection:
              type: null
          container:
            projection:
              type: null
```

xd-yarn command synopsis

push

```
xd-yarn push - Push new application version

usage: xd-yarn push [options]

Option          Description
-----
-v, --application-version Application version (default: app)
```

pushed

```
xd-yarn pushed - List pushed applications

usage: xd-yarn pushed [options]

No options specified
```

submit

```

xd-yarn submit - Submit application

usage: xd-yarn submit [options]

Option                Description
-----                -
-v, --application-version Application version (default: app)

```

submitted

```

xd-yarn submitted - List submitted applications

usage: xd-yarn submitted [options]

Option                Description
-----                -
-t, --application-type Application type (default: XD)
-v, --verbose [Boolean] Verbose output (default: true)

```

kill

```

xd-yarn kill - Kill application

usage: xd-yarn kill [options]

Option                Description
-----                -
-a, --application-id Specify YARN application id

```

clustersinfo

```

xd-yarn clustersinfo - List clusters

usage: xd-yarn clustersinfo [options]

Option                Description
-----                -
-a, --application-id Specify YARN application id

```

clusterinfo

```

xd-yarn clusterinfo - List cluster info

usage: xd-yarn clusterinfo [options]

Option                Description
-----                -
-a, --application-id Specify YARN application id
-c, --cluster-id Specify cluster id
-v, --verbose [Boolean] Verbose output (default: true)

```

clustercreate

```

xd-yarn clustercreate - Create cluster

usage: xd-yarn clustercreate [options]

Option                Description
-----
-a, --application-id  Specify YARN application id
-c, --cluster-id      Specify cluster id
-g, --container-groups Container groups
-h, --projection-hosts Projection hosts counts
-i, --cluster-def      Specify cluster def id
-p, --projection-type  Projection type
-r, --projection-racks Projection racks counts
-w, --projection-any   Projection any count
-y, --projection-data  Raw projection data

```

clusterdestroy

```

xd-yarn clusterdestroy - Destroy cluster

usage: xd-yarn clusterdestroy [options]

Option                Description
-----
-a, --application-id  Specify YARN application id
-c, --cluster-id      Specify cluster id

```

clustermodify

```

xd-yarn clustermodify - Modify cluster

usage: xd-yarn clustermodify [options]

Option                Description
-----
-a, --application-id  Specify YARN application id
-c, --cluster-id      Specify cluster id
-h, --projection-hosts Projection hosts counts
-r, --projection-racks Projection racks counts
-w, --projection-any   Projection any count
-y, --projection-data  Raw projection data

```

clusterstart

```

xd-yarn clusterstart - Start cluster

usage: xd-yarn clusterstart [options]

Option                Description
-----
-a, --application-id  Specify YARN application id
-c, --cluster-id      Specify cluster id

```

clusterstop

```

xd-yarn clusterstop - Stop cluster

usage: xd-yarn clusterstop [options]

Option                Description
-----
-a, --application-id  Specify YARN application id
-c, --cluster-id      Specify cluster id

```

Introduction to YARN resource allocation

This section describes some background of how YARN resource allocation works, what are the limitations of it and more importantly how it reflects into `XD YARN runtime`.

Note

More detailed info of resource allocation can be found from a [Spring for Apache Hadoop](#) reference documentation.

YARN as having a strong roots from original MapReduce framework is imposing relatively strange concepts of where containers are about to be executed. In a MapReduce world every map and reduce tasks are executed in its own container where colocation is usually determined by a physical location of a HDFS file block map or reduce tasks are accessing. This is introducing a concepts of allocating containers on `any hosts`, `specific hosts` or `specific racks`. Usually YARN is trying to place container as close as possible to a physical location to minimize network IO so i.e. if host cannot be chosen, rack is chosen instead assuming a whole rack is connected together with a fast switch.

For custom YARN applications like `XD YARN runtime` this doesn't necessarily make that much sense because we're not hard-tied to HDFS file blocks. What makes sense is that we can still place containers on different racks to get better high availability in case whole rack goes down or if specific containers needs to exist on specific hosts to access either custom physical or network resources. Good example of having a need to execute something on a specific host is either a disk access or outbound internet access if cluster is highly secured.

One other YARN resource allocation concept worth mentioning is relaxation of container locality. This simply means that if resources are requested from hosts or racks, YARN will relax those requests if resources cannot be allocated immediately. Turning `relax` flag off guarantees that containers will be allocated from hosts or racks. Though these requests will then wait forever if allocation cannot be done.

3. Application Configuration

3.1 Introduction

There are two main parts of Spring XD that can be configured, servers and modules.

The servers (`xd-singlenode`, `xd-admin`, `xd-container`) are [Spring Boot](#) applications and are configured as described in the [Spring Boot Reference documentation](#). In the most simple case this means editing values in the YAML based configuration file `servers.yml`. The values in this configuration file will overwrite the values in the default [application.yml](#) file that is embedded in the XD jar.

Note

The use of YAML is an alternative to using property files. YAML is a superset of JSON, and as such is a very convenient format for specifying hierarchical configuration data.

For modules, each module has its own configuration file located in its own directory, for example `source/http/http.properties`. Shared configuration values for modules can be placed in a common `modules.yml` file.

For both server and module configuration, you can have environment specific settings through the use of application profiles and the ability to override values in files by setting OS environment variables.

In this section we will walk through how to configure servers and modules.

3.2 Server Configuration

The startup scripts for `xd-singlenode`, `xd-admin`, and `xd-container` will by default look for the file `$XD_HOME\config\servers.yml` as a source of externalized configuration information.

The location and name of this resource can be changed by using the environment variables `XD_CONFIG_LOCATION` and `XD_CONFIG_NAME`. The start up script takes the value of these environment variables to set the Spring Boot properties `spring.config.location` and `spring.config.name`. Note, that for `XD_CONFIG_LOCATION` you can reference any [Spring Resource](#) implementation, most commonly denoted using the prefixes `classpath:`, `file:` and `http:`.

It is common to keep your server configuration separate from the installation directory of XD itself. To do this, here is an example environment variable setting

```
export XD_CONFIG_LOCATION=file:/xd/config/  
export XD_CONFIG_NAME=region1-servers
```

Note: the file path separator ("/") at the end of `XD_CONFIG_LOCATION` is **necessary**.

Profile support

Profiles provide a way to segregate parts of your application configuration and change their availability and/or values based on the environment. This lets you have different configuration settings for `qa` and `prod` environments and to easily switch between them.

To activate a profile, set the OS environment variable `SPRING_PROFILES_ACTIVE` to a comma delimited list of profile names. The server looks to load profile specific variants of the

`servers.yml` file based on the naming convention `servers-{profile}.yml`. For example, if `SPRING_PROFILES_ACTIVE=prod` the following files would be searched for in the following order.

1. `XD_CONFIG_LOCATION/servers-prod.yml`
2. `XD_CONFIG_LOCATION/servers.yml`

You may also put multiple profile specific configuration in a single `servers.yml` file by using the key `spring.profiles` in different sections of the configuration file. See [Multi-profile YAML documents](#) for more information.

Database Configuration

Spring XD saves the state of the batch job workflows in a relational database. When running `xd-singlensode` an embedded HSQLDB database is run. When running in distributed mode a standalone HSQLDB instance can be used, the startup script `hsqldb-server` is in is provided the installation directory under the folder `hsqldb/bin`. It is recommended to use HSQLDB only for development and learning.

When deploying in a production environment, you will need to select another database. Spring XD is actively tested on MySQL (Version: 5.1.23) and Postgres (Version 9.2-1002). All batch workflow tables are automatically created, if they do not exist, for HSQLDB, MySQL and Postgres. The JDBC driver jars for the HSQLDB and Postgres are already on the XD classpath.

The provided configuration file `servers.yml` located in `$XD_HOME\config` has commented out configuration for some commonly used databases. You can use these as a basis to support your database environment. XD also utilizes the Tomcat jdbc connection pool and these settings can be configured in the `servers.yml`.

Note

Until full schema support is added for Oracle, Sybase and other database, you will need to put a .jar file in the `xd/lib` directory that contains the equivalent functionality as these [DDL scripts](#).

Note

There was a schema change in version 1.0 RC1. Use or adapt the the [sample migration class](#) to update your schema.

HSQLDB

When in distributed mode and you want to use HSQLDB, you need to change the value of `spring.datasource` properties. As an example,

```
hsqldb:
  server:
    host: localhost
    port: 9102
    dbname: xdjob
  spring:
    datasource:
      url: jdbc:hsqldb:hsqldb://${hsqldb.server.host:localhost}:${hsqldb.server.port:9101}/
      ${hsqldb.server.dbname:xdjob}
      username: sa
      password:
      driverClassName: org.hsqldb.jdbc.JDBCdriver
```

The properties under `hsqldb.server` are substituted in the `spring.datasource.url` property value. This lets you create short variants of existing Spring Boot properties. Using this style, you can override the value of these configuration variables by setting an OS environment variable, such as `xd_server_host`. Alternatively, you can not use any placeholders and set `spring.datasource.url` directly to known values.

MySQL

When in distributed mode and you want to use MySQL, you need to change the value of `spring.datasource.*` properties. As an example,

```
spring:
  datasource:
    url: jdbc:mysql://yourDBhost:3306/yourDB
    username: yourUsername
    password: yourPassword
    driverClassName: com.mysql.jdbc.Driver
```

To override these settings set an OS environment variable such as `spring_datasource_url` to the value you require.

PostgreSQL

When in distributed mode and you want to use PostgreSQL, you need to change the value of `spring.datasource.*` properties. As an example,

```
spring:
  datasource:
    url: jdbc:postgresql://yourDBhost:5432/yourDB
    username: yourUsername
    password: yourPassword
    driverClassName: org.postgresql.Driver
```

To override these settings set an OS environment variable such as `spring_datasource_url` to the value you require.

Redis

If you want to use Redis for analytics or data transport you should set the host and port of the Redis server.

```
spring:
  redis:
    port: 6379
    host: localhost
```

To override these settings set an OS environment variable such as `spring_redis_port` to the value you require.

You can also configure redis to use Sentinel.

```
spring:
  redis:
    port: 6379
    host: host1
    sentinel:
      master: mymaster
      nodes: host2:26379,host3:26380,host4:26381
```

In addition, the following default settings for the rabbit message bus can be modified in `servers.yml`...

```

redis:
  headers: ❶
  default:
    backOffInitialInterval: 1000 ❷
    backOffMaxInterval: 10000 ❸
    backOffMultiplier: 2.0 ❹
    concurrency: 1 ❺
    maxAttempts: 32 ❻

```

- ❶ comma-delimited list of additional (string-valued) header names to transport
- ❷ The time in milliseconds before retrying a failed message delivery
- ❸ The maximum time (ms) to wait between retries
- ❹ The back off multiplier (previous interval x multiplier = next interval)
- ❺ The minimum number of consumer threads receiving messages for a module
- ❻ The maximum number of delivery attempts

RabbitMQ

If you want to use RabbitMQ as a data transport use the following configuration setting

```

spring:
  rabbitmq:
    addresses: localhost:5672
    username: guest
    password: guest
    virtual_host: /
    useSSL: false
    sslProperties:

```

To override these settings set an OS environment variable such as `spring_rabbitmq_host` to the value you require.

See [Message Bus](#) regarding SSL configuration.

In addition, the following default settings for the rabbit message bus can be modified in `servers.yml`...

```

messagebus:
  rabbit:
    compressionLevel: 1 ❶
    default:
      ackMode: AUTO ❷
      autoBindDLQ: false ❸
      backOffInitialInterval: 1000 ❹
      backOffMaxInterval: 10000 ❺
      backOffMultiplier: 2.0 ❻
      batchSizeLimit: 10000 ❼
      batchingEnabled: false ❽
      batchSize: 100 ❾
      batchTimeout: 5000 ❿
      compress: false 11
      concurrency: 1 12
      durableSubscription: false 13
      maxAttempts: 3 14
      maxConcurrency: 1 15
      prefix: xdbus. 16
      prefetch: 1 17
      replyHeaderPatterns: STANDARD_REPLY_HEADERS,* 18
      republishToDLQ: false 19
      requestHeaderPatterns: STANDARD_REQUEST_HEADERS,* 20
      requeue: true 21
      transacted: false 22
      txSize: 1 23

```

- ❶ When the bus (or a stream module deployment) is configured to compress messages, specifies the compression level. See *java.util.zip.Deflater* for available values; defaults to 1 (BEST_SPEED)
- ❷ AUTO (container acks), NONE (broker acks), MANUAL (consumer acks). Upper case only. Note: MANUAL requires specialized code in the consuming module and is unlikely to be used in an XD application. For more information, see <http://docs.spring.io/spring-integration/reference/html/amqp.html#amqp-inbound-ack>
- ❸ When true, the bus will automatically declare dead letter queues and binding for each bus queue. The user is responsible for setting a policy on the broker to enable dead-lettering; see [Message Bus Configuration](#) for more information. The bus will configure a dead-letter-exchange (`<prefix>DLX`) and bind a queue with the name `<original queue name>.dlq` and route using the original queue name
- ❹ The time in milliseconds before retrying a failed message delivery
- ❺ The maximum time (ms) to wait between retries
- ❻ The back off multiplier (previous interval x multiplier = next interval)
- ❼ When batching is enabled, the size of the buffer that will cause a batch to be released (overrides *batchSize*)
- ❽ True to enable message batching by producers
- ❾ The number of messages in a batch (may be preempted by *batchBufferLimit* or *batchTimeout*)
- ❿ The idle time to wait before sending a partial batch
- ⓫ True to enable message compression - also see (1. bus *compressionLevel*)
- ⓬ The minimum number of consumer threads receiving messages for a module
- ⓭ When `true` queues for subscriptions to publish/subscribe named channels (`tap:`, `topic:`) will be declared as durable and are eligible for dead-letter configuration according to the `autoBindDLQ` setting.
- ⓮ The maximum number of delivery attempts. Setting this to 1 disables the retry mechanism and `requeue` must be set to false if you wish failed messages to be rejected or routed to a DLQ. Otherwise deliveries will be attempted repeatedly, with no termination. Also see `republishToDLQ`
- ⓯ The maximum number of consumer threads receiving messages for a module
- ⓰ A prefix applied to all queues, exchanges so that policies (HA etc) can be applied
- ⓱ The number of messages to prefetch for each consumer
- ⓲ Determines which reply headers will be transported
- ⓳ By default, failed messages after retries are exhausted are rejected. If a dead-letter queue (DLQ) is configured, rabbitmq will route the failed message (unchanged) to the DLQ. Setting this property to `true` instructs the bus to republish failed messages to the DLQ, with additional headers, including the exception message and stack trace from the cause of the final failure. Note that the republish will occur even if `maxAttempts` is only set to 1. Also see `autoBindDLQ`
- ⓴ Determines which request headers will be transported
- ⓵ Whether rejected messages will be requeued by default
- ⓶ Whether the channel is to be transacted
- ⓷ The number of messages to process between acks (when ack mode is AUTO).

Kafka

If you want to use Kafka as a data transport, the following connection settings, as well as defaults for the kafka message bus can be modified in `servers.yml`.

Note

To ensure the proper functioning of the Kafka Message Bus, you must enable log cleaning in your Kafka configuration. This is set using the configuration variable `log.cleaner.enable=true`. See the [Kafka documentation](#) for additional configuration options for log cleaning.

Note

At this time, the Kafka message bus does not support job processing. This feature will be available in a future release.

```
messagebus:
  kafka:
    brokers:                localhost:9092 ❶
    zkAddress:              localhost:2181 ❷
    default:
      batchingEnabled:     false ❸
      batchSize:           200    ❹
      batchTimeout:        5000   ❺
      replicationFactor:   1      ❻
      concurrency:         1      ❼
      requiredAcks:        1      ❽
      compressionCodec:    default ❾
      offsetStoreTopic:    SpringXdOffsets ❿
```

- ❶ A list of Kafka broker addresses, for sending messages
- ❷ A list of ZooKeeper addresses, for receiving messages
- ❸ True to enable message batching by producers by default
- ❹ The number of messages in a batch (may be preempted by *batchTimeout*)
- ❺ The idle time to wait before sending a partial batch
- ❻ The replication factor of the topics created by the message bus. At least as many brokers must be in the cluster when the topic is being created.
- ❼ The maximum number of consumer threads receiving messages for a module. The total number of threads actively consuming partitions across all the instances of a specific module cannot be larger than the partition count of a transport topic - therefore, if such a situation occurs, some modules instances will, in fact, use less consumer threads.
- ❽ The number of required acks when producing messages, i.e. how many brokers have committed data to the logs and acknowledged this to the leader. Special values are `-1`, meaning all in-sync replicas, and `0` indicating that no acks are necessary.
- ❾ Enables compression for the bus and sets the compression codec.
- ❿ The name of the topic that will be used to store client offset values. ===== Admin Server HTTP Port

The default HTTP port of the `xd-admin` server is 9393. To change the value use the following configuration setting

```
server:
  port: 9876
```

Management Port

The XD servers provide general [health](#) and JMX exported [management](#) endpoints via Jolokia.

By default the management and health endpoints are available on port 9393. To change the value of the port use the following configuration setting to `servers.yml`.

```
management:
  port: 9876
```

You can also disable http management endpoints by setting the port value to -1.

By default JMX MBeans are exported. You can disable JMX by setting `spring.jmx.enabled=false`.

The section on [Monitoring and management over HTTP](#) provides details on how to configure these endpoint.

Admin Server Security

By default, the Spring XD admin server is unsecured and runs on an unencrypted HTTP connection. You can secure your administration REST endpoints, as well as the Admin UI by enabling HTTPS and requiring clients to authenticate.

Enabling HTTPS

By default, the administration, management, and health endpoints, as well as the Admin UI use HTTP as a transport. You can switch to HTTPS easily, by adding a certificate to your configuration in `servers.yml`

```
spring:
  profiles: admin
server:
  ssl:
    key-alias: yourKeyAlias
    key-store: path/to/keystore
    key-store-password: yourKeyStorePassword
    key-password: yourKeyPassword
    trust-store: path/to/trust-store
    trust-store-password: yourTrustStorePassword
```

- ❶ The settings are applicable only to the admin server (regardless whether it's started in single-node mode or as a separate instance).
- ❷ The alias (or name) under which the key is stored in the keystore.
- ❸ The path to the keystore file. Classpath resources may also be specified, by using the classpath prefix: `classpath:path/to/keystore`
- ❹ The password of the keystore.
- ❺ The password of the key.
- ❻ The path to the truststore file. Classpath resources may also be specified, by using the classpath prefix: `classpath:path/to/trust-store`
- ❼ The password of the trust store.

Note

If HTTPS is enabled, it will completely replace HTTP as the protocol over which the REST endpoints and the Admin UI interact. Plain HTTP requests will fail - therefore, make sure that you configure your Shell accordingly.

Enabling authentication

By default, the REST endpoints (administration, management and health), as well as the Admin UI do not require authenticated access. By turning on authentication on the admin server:

- the REST endpoints will require Basic authentication for access;
- the Admin UI will be accessible after signing in through a web form.

Note

When authentication is set up, it is strongly recommended to enable HTTPS as well, especially in production environments.

You can turn on authentication by adding the following to the configuration in `servers.yml`:

```
spring:
  profiles: admin
security:
  basic:
    enabled: true
    realm: SpringXD
  user:
    name: yourAdminUsername
    password: yourAdminPassword
    role: ADMIN, VIEW, CREATE
```

- ❶ The settings are applicable only to the admin server (regardless whether it's started in single node mode or as a separate instance).
- ❷ Must be set to `true` for security to be enabled.
- ❸ (Optional) The realm for Basic authentication. Will default to `SpringXD` if not explicitly set.
- ❹ Must set with appropriate roles (`ADMIN`, `VIEW` and `CREATE`) to enable. Note: the prefix `ROLE_` isn't required here.

Additionally, you must specify an authentication method, out of the following that Spring XD supports:

- single user mode (the default made available by Spring Boot)
- integration with an existing LDAP server
- file based configuration

The options above are mutually exclusive, and they are described below.

Single user authentication

This option uses a single username/password pair is created for the server. This option is turned on by default, if security is enabled and LDAP is not configured.

You can configure this option by adding the following to the configuration in `servers.yml`, once security is enabled.

```
spring:
  profiles: admin
security:
  basic:
    enabled: true
    realm: SpringXD
  user:
    name: yourAdminUsername
    password: yourAdminPassword
```

- ❶ The username for authentication (must be used by REST clients and in the Admin UI). Will default to `user` if not explicitly set.

- ② The password for authentication (must be used by REST clients and in the Admin UI). If not explicitly set, it will be auto-generated, as described in the [Spring Boot](#) documentation.

LDAP authentication

Spring XD also supports authentication against an LDAP server, in both direct bind and "search and bind" modes. When the LDAP authentication option is activated, the default single user mode is turned off.

In direct bind mode, a pattern is defined for the user's distinguished name (DN), using a placeholder for the username. The authentication process derive the distinguished name of the user by replacing the placeholder and use it to authenticate a user against the LDAP server, along with the supplied password. You can set up LDAP direct bind as follows:

```
spring:
  profiles: admin
  security:
    basic:
      enabled: true
      realm: SpringXD
  xd:
    security:
      authentication:
        ldap:
          enabled: true
          url: ldap://ldap.example.com:3309
          userDnPattern: uid={0},ou=people,dc=example,dc=com
```

- ① Enables LDAP integration
- ② The URL for the LDAP server
- ③ The distinguished name (DN) pattern for authenticating against the server.

The "search and bind" mode involves connecting to an LDAP server, either anonymously or with a fixed account, and searching for the distinguished name of the authenticating user based on its username, and then using the resulting value and the supplied password for binding to the LDAP server. This option is configured as follows:

```
spring:
  profiles: admin
  security:
    basic:
      enabled: true
      realm: SpringXD
  xd:
    security:
      authentication:
        ldap:
          enabled: true
          url: ldap://ldap.example.com:3309
          managerDn: uid=bob,ou=managers,dc=example,dc=com
          managerPassword: managerPassword
          userSearchBase: ou=otherpeople,dc=example,dc=com
          userSearchFilter: uid={0}
```

- ① Enables LDAP integration
- ② The URL of the LDAP server
- ③ A DN for to authenticate to the LDAP server, if anonymous searches are not supported (optional, required together with next option)
- ④ A password to authenticate to the LDAP server, if anonymous searches are not supported (optional, required together with previous option)

- ⑤ The base for searching the DN of the authenticating user (serves to restrict the scope of the search)
- ⑥ The search filter for the DN of the authenticating user

File based authentication

Spring XD supports listing users in a configuration file, as described below. Each user must be assigned a password and one or more roles:

```
spring:
  profiles: admin
  security:
    basic:
      enabled: true
      realm: SpringXD
  xd:
    security:
      authentication:
        file:
          enabled: true           ❶
          users:                 ❷
            bob: bobspassword, ROLE_VIEW ❸
            alice: alicepwd, ROLE_ADMIN
```

- ❶ Enables file based integration
- ❷ This is a yaml map of username to (password and roles)
- ❸ Each map "value" is made of a password and one or more roles, comma separated

Customizing authorization

All of the above deals with authentication, *i.e.* how to assess the identity of the user. Irrespective of the option chosen, you can also customize **authorization** *i.e.* who can do what.

The default scheme uses three roles to protect the [REST endpoints](#) that Spring XD exposes:

- **ROLE_VIEW** for anything that relates to retrieving state
- **ROLE_CREATE** for anything that involves creating, deleting or mutating the state of the system
- **ROLE_ADMIN** for boot management endpoints.

All of those defaults are written out in `application.yml`, which you can choose to override *via* `servers.yml`. This takes the form of a **YAML list** (as some rules may have precedence over others) and so you'll need to copy/paste the whole list and tailor it to your needs (as there is no way to merge lists). Always refer to your version of `application.yml`, as the snippet reproduced below may be outdated. The default rules are as such:

```

security:
  authorization:
    rules:
      # Streams
      - GET /streams/definitions => hasRole('ROLE_VIEW')
      - DELETE /streams/definitions => hasRole('ROLE_CREATE')
      - GET /streams/definitions/* => hasRole('ROLE_VIEW')
      - POST /streams/definitions => hasRole('ROLE_CREATE')
      - DELETE /streams/definitions/* => hasRole('ROLE_CREATE')
      # Stream Deployments
      - GET /streams/deployments/ => hasRole('ROLE_VIEW')
      - DELETE /streams/deployments/ => hasRole('ROLE_CREATE')
      - GET /streams/deployments/* => hasRole('ROLE_VIEW')
      - POST /streams/deployments/* => hasRole('ROLE_CREATE')
      - DELETE /streams/deployments/* => hasRole('ROLE_CREATE')
      # Job Definitions
      - GET /jobs/definitions => hasRole('ROLE_VIEW')
      - DELETE /jobs/definitions => hasRole('ROLE_CREATE')
      - GET /jobs/definitions/* => hasRole('ROLE_VIEW')
      - POST /jobs/definitions => hasRole('ROLE_CREATE')
      - DELETE /jobs/definitions/* => hasRole('ROLE_CREATE')
      # Job Deployments
      - GET /jobs/deployments/ => hasRole('ROLE_VIEW')
      - DELETE /jobs/deployments/ => hasRole('ROLE_CREATE')
      - GET /jobs/deployments/* => hasRole('ROLE_VIEW')
      - POST /jobs/deployments/* => hasRole('ROLE_CREATE')
      - DELETE /jobs/deployments/* => hasRole('ROLE_CREATE')
      # Batch Job Configurations
      - GET /jobs/configurations => hasRole('ROLE_VIEW')
      - GET /jobs/configurations/* => hasRole('ROLE_VIEW')
      # Batch Job Executions
      - GET /jobs/executions => hasRole('ROLE_VIEW')
      - PUT /jobs/executions?stop=true => hasRole('ROLE_CREATE')
      - GET /jobs/executions?jobname=* => hasRole('ROLE_VIEW')
      - POST /jobs/executions?jobname=* => hasRole('ROLE_CREATE')
      - GET /jobs/executions/* => hasRole('ROLE_VIEW')
      - PUT /jobs/executions/*?restart=true => hasRole('ROLE_CREATE')
      - PUT /jobs/executions/*?stop=true => hasRole('ROLE_CREATE')
      - GET /jobs/executions/*/steps => hasRole('ROLE_VIEW')
      - GET /jobs/executions/*/steps/* => hasRole('ROLE_VIEW')
      - GET /jobs/executions/*/steps/*/progress => hasRole('ROLE_VIEW')
      # Batch Job Instances
      - GET /jobs/instances?jobname=* => hasRole('ROLE_VIEW')
      - GET /jobs/instances/* => hasRole('ROLE_VIEW')
      # Module Definitions
      - GET /modules => hasRole('ROLE_VIEW')
      - POST /modules => hasRole('ROLE_CREATE')
      - GET /modules/*/* => hasRole('ROLE_VIEW')
      - DELETE /modules/*/* => hasRole('ROLE_CREATE')
      # Deployed Modules
      - GET /runtime/modules => hasRole('ROLE_VIEW')
      # Containers
      - GET /runtime/containers => hasRole('ROLE_VIEW')
      # Counters
      - GET /metrics/counters => hasRole('ROLE_VIEW')
      - GET /metrics/counters/* => hasRole('ROLE_VIEW')
      - DELETE /metrics/counters/* => hasRole('ROLE_CREATE')
      # Field Value Counters
      - GET /metrics/field-value-counters => hasRole('ROLE_VIEW')
      - GET /metrics/field-value-counters/* => hasRole('ROLE_VIEW')
      - DELETE /metrics/field-value-counters/* => hasRole('ROLE_CREATE')
      # Aggregate Counters
      - GET /metrics/aggregate-counters => hasRole('ROLE_VIEW')
      - GET /metrics/aggregate-counters/* => hasRole('ROLE_VIEW')
      - DELETE /metrics/aggregate-counters/* => hasRole('ROLE_CREATE')
      # Gauges
      - GET /metrics/gauges => hasRole('ROLE_VIEW')
      - GET /metrics/gauges/* => hasRole('ROLE_VIEW')
      - DELETE /metrics/gauges/* => hasRole('ROLE_CREATE')
      # Rich Gauges
      - GET /metrics/rich-gauges => hasRole('ROLE_VIEW')
      - GET /metrics/rich-gauges/* => hasRole('ROLE_VIEW')
      - DELETE /metrics/rich-gauges/* => hasRole('ROLE_CREATE')
      # Tab Completions
      - GET /completions/stream?start=* => hasRole('ROLE_VIEW')
      - GET /completions/job?start=* => hasRole('ROLE_VIEW')
      - GET /completions/module?start=* => hasRole('ROLE_VIEW')
      # Boot Endpoints
      - GET /boot/health => hasRole('ROLE_VIEW')

```

The format of each line is the following:

```
HTTP_METHOD URL_PATTERN '=>' SECURITY_ATTRIBUTE
```

where

- HTTP_METHOD is one http method, capital case
- URL_PATTERN is an Ant style URL pattern
- SECURITY_ATTRIBUTE is a SpEL expression (see <http://docs.spring.io/spring-security/site/docs/4.0.0.M2/reference/htmlsingle/#el-access>)
- each of those separated by one or several blank characters (spaces, tabs, etc.)

Be mindful that the above is indeed a YAML list, not a map (thus the use of - dashes at the start of each line) that lives under the `security.authorization.rules` key.

Local transport

Local transport uses a [QueueChannel](#) to pass data between modules. There are a few properties you can configure on the QueueChannel

- `xd.local.transport.named.queueSize` - The capacity of the queue, the default value is `Integer.MAX_VALUE`
- `xd.local.transport.named.polling` - Messages that are buffered in a QueueChannel need to be polled to be consumed. This property controls the fixed rate at which polling occurs. The default value is 1000 ms.

3.3 Module Configuration

Modules are configured by placing property files in a nested directory structure based on their type and name. The root of the nested directory structure is by default `XD_HOME/config/modules`. This location can be customized by setting the OS environment variable `XD_MODULE_CONFIG_LOCATION`, similar to how the environment variable `XD_CONFIG_LOCATION` is used for configuring the server. If `XD_MODULE_CONFIG_LOCATION` is set explicitly, then it is **necessary** to add the file path separator ("/") at the end of the path.

Note

If `XD_MODULE_CONFIG_LOCATION` is set to use explicit location, make sure to copy entire directory structure from the default module config location `xd/config/modules` into the new module config location. The `XD_MODULE_CONFIG_LOCATION` can reference any [Spring Resource](#) implementation, most commonly denoted using the prefixes `classpath:`, `file:` and `http:`.

As an example, if you wanted to configure the twittersearch module, you would create a file

```
XD_MODULE_CONFIG_LOCATION\source\twittersearch\twittersearch.properties
```

and the contents of that file would be property names such as `consumerKey` and `consumerSecret`.

Note

You **do not** need to prefix these property names with a `source.twittersearch` prefix.

You can override the values in the module property file in various ways. The following sources of properties are considered in the following order.

1. Properties specified in the stream or job DSL definition
2. Java System Properties (e.g. `source.http.port=9454`)
3. OS environment variables. (e.g. `source_http_port=9454`)
4. `XD_MODULE_CONFIG_LOCATION\<type>\<name>\<name>.properties` (including profile variants)
5. Default values specified in module metadata (if available).

Values in `XD_MODULE_CONFIG_LOCATION\<type>\<name>\<name>.properties` can be property placeholder references to keys defined in another resource location. By default the resource is the file `XD_MODULE_CONFIG_LOCATION\modules.yml`. You can customize the name of the resource by using setting the OS environment variable `XD_MODULE_CONFIG_NAME` before running a server startup script.

The `modules.yml` file can be used to specify the values of keys that should be shared across different modules. For example, it is common to use the same twitter developer credentials in both the `twittersearch` and `twitterstream` modules. To avoid repeating the same credentials in two property files, you can use the following setup.

`modules.yml` contains

```
sharedConsumerKey: alsdjfqwopieur
sharedConsumerSecret: pqwieouralsjdkqwp
sharedAccessToken: llixzchvpiawued
sharedAccessTokenSecret: ewoqirudhdsldke
```

and `XD_MODULE_CONFIG_LOCATION\source\twitterstream\twitterstream.properties` contains

```
consumerKey=${sharedConsumerKey}
consumerSecret=${sharedConsumerSecret}
accessToken=${sharedAccessToken}
accessTokenSecret=${sharedAccessTokenSecret}
```

and `XD_MODULE_CONFIG_LOCATION\source\twittersearch\twittersearch.properties` contains

```
consumerKey=${sharedConsumerKey}
consumerSecret=${sharedConsumerSecret}
```

Profiles

When resolving property file names, the server will look to load profile specific variants based on the naming convention `<name>-{profile}.properties`. For example, if given the OS environment variable `spring_profiles_active=default,qa` the following configuration file names for the `twittersearch` module would be searched in this order

1. `XD_MODULE_CONFIG_LOCATION\source\twittersearch\twittersearch.properties`
2. `XD_MODULE_CONFIG_LOCATION\source\twittersearch\twittersearch-default.properties`
3. `XD_MODULE_CONFIG_LOCATION\source\twittersearch\twittersearch-qa.properties`

Also, the shared module configuration file is referenced using profile variants, so given the OS environment variable `spring_profiles_active=default,qa` the following shared module configuration files would be searched for in this order

1. `XD_MODULE_CONFIG_LOCATION\modules.yml`
2. `XD_MODULE_CONFIG_LOCATION\modules-default.yml`
3. `XD_MODULE_CONFIG_LOCATION\modules-qa.yml`

Batch Jobs or modules accessing JDBC

Another common case is access to a relational database from a job or the JDBC Sink module.

As an example, to provide the properties for the batch job `jdbchdfs` the file `XD_MODULE_CONFIG_LOCATION\job\jdbchdfs\jdbchdfs.properties` should contain

```
driverClass=org.hsqldb.jdbc.JDBCDriver
url=jdbc:hsqldb:mem:xd
username=sa
password=
```

A property file with the same keys, but likely different values would be located in `XD_MODULE_CONFIG_LOCATION\sink\jdbc\jdbc.properties`.

4. DSL Guide

4.1 Introduction

Spring XD provides a DSL for defining a stream. Over time the DSL is likely to evolve significantly as it gains the ability to define more and more sophisticated streams as well as the steps of a batch job.

4.2 Pipes and filters

A simple linear stream consists of a sequence of modules. Typically an Input Source, (optional) Processing Steps, and an Output Sink. As a simple example consider the collection of data from an HTTP Source writing to a File Sink. Using the DSL the stream description is:

```
http | file
```

A stream that involves some processing:

```
http | filter | transform | file
```

The modules in a stream definition are connected together using the pipe symbol `|`.

4.3 Module parameters

Each module may take parameters. The parameters supported by a module are defined by the module implementation. As an example the `http` source module exposes `port` setting which allows the data ingestion port to be changed from the default value.

```
http --port=1337
```

It is only necessary to quote parameter values if they contain spaces or the `|` character. Here the `transform` processor module is being passed a SpEL expression that will be applied to any data it encounters:

```
transform --expression='new StringBuilder(payload).reverse()'
```

If the parameter value needs to embed a single quote, use two single quotes:

```
// Query is: Select * from /Customers where name='Smith'  
scan --query='Select * from /Customers where name=''Smith'''
```

4.4 Named channels

Instead of a source or sink it is possible to use a named channel. Normally the modules in a stream are connected by anonymous internal channels (represented by the pipes), but by using explicitly named channels it becomes possible to construct more sophisticated flows. In keeping with the unix theme, sourcing/sinking data from/to a particular channel uses the `>` character. A named channel is specified by using a channel type, followed by a `:` followed by a name. The channel types available are:

```
queue - this type of channel has point-to-point (p2p) semantics
```

```
topic - this type of channel has pub/sub semantics
```

Here is an example that shows how you can use a named channel to share a data pipeline driven by different input sources.

```
queue:foo > file
```

```
http > queue:foo
```

```
time > queue:foo
```

Now if you post data to the http source, you will see that data intermingled with the time value in the file.

The opposite case, the fanout of a message to multiple streams, is planned for a future release. However, [taps](#) are a specialization of named channels that do allow publishing data to multiple sinks. For example:

```
tap:stream:mystream > file
```

```
tap:stream:mystream > log
```

Once data is received on `mystream`, it will be written to both file and log.

Support for routing messages to different streams based on message content is also planned for a future release.

4.5 Labels

Labels provide a means to alias or group modules. Labels are simply a name followed by a `:`. When used as an alias a label can provide a more descriptive name for a particular configuration of a module and possibly something easier to refer to in other streams.

```
mystream = http | obfuscator: transform --expression=payload.replaceAll('password','*') | file
```

Labels are especially useful (and required) for disambiguating when multiple modules of the same name are used:

```
mystream = http | uppercaser: transform --expression=payload.toUpperCase() | exclaimer: transform --expression=payload+'!' | file
```

Refer to [this section](#) of the Taps chapter to see how labels facilitate the creation of taps in these cases where a stream contains ambiguous modules.

4.6 Single quotes, Double quotes, Escaping

Spring XD is a complex runtime that involves a lot of systems when you look at the complete picture. There is a **Spring Shell based client** that talks to the admin that is responsible for **parsing**. In turn, modules may themselves rely on embedded languages (like the **Spring Expression Language**) to accomplish their behavior.

Those three components (shell, XD parser and SpEL) have rules about how they handle quotes and how syntax escaping works, and when stacked with each other, confusion may arise. This section explains the rules that apply and provides examples to the most common situations.

It's not always that complicated

This section focuses on the most complicated cases, when all 3 layers are involved. Of course, if you don't use the XD shell (for example if you're using the REST API directly) or if module option values are not SpEL expressions, then escaping rules can be much simpler

Spring Shell

Arguably, the most complex component when it comes to quotes is the shell. The rules can be laid out quite simply, though:

- a shell command is made of keys (`--foo`) and corresponding values. There is a special, key-less mapping though, see below
- a value can not normally contain spaces, as space is the default delimiter for commands
- spaces can be added though, by surrounding the value with quotes (either single `'` or double `"` quotes)
- if surrounded with quotes, a value can embed a literal quote of the same kind by prefixing it with a backslash (`\`)
- Other escapes are available, such as `\t`, `\n`, `\r`, `\f` and unicode escapes of the form `\uxxxx`
- Lastly, the key-less mapping is handled in a special way in the sense that it does not need quoting to contain spaces

For example, the XD shell supports the `!` command to execute native shell commands. The `!` accepts a single, key-less argument. This is why the following works:

```
xd:>! rm foo
```

The argument here is the whole `rm foo` string, which is passed as is to the underlying shell.

As another example, the following commands are strictly equivalent, and the argument value is `foo` (without the quotes):

```
xd:>stream destroy foo
xd:>stream destroy --name foo
xd:>stream destroy "foo"
xd:>stream destroy --name "foo"
```

XD Syntax

At the XD parser level (that is, inside the body of a stream or job definition) the rules are the following:

- option values are normally parsed until the first space character
- they can be made of literal strings though, surrounded by single or double quotes
- To embed such a quote, use two consecutive quotes of the desired kind

As such, the values of the `--expression` option to the filter module are semantically equivalent in the following examples:

```
filter --expression=payload>5
filter --expression="payload>5"
filter --expression='payload>5'
filter --expression='payload > 5'
```

Arguably, the last one is more readable. It is made possible thanks to the surrounding quotes. The actual expression is `payload > 5` (without quotes).

Now, let's imagine we want to test against string messages. If we'd like to compare the payload to the SpEL literal string, `"foo"`, this is how we could do:

```
filter --expression=payload=='foo'           ❶
filter --expression='payload == 'foo''       ❷
filter --expression='payload == "foo"'       ❸
```

- ❶ This works because there are no spaces. Not very legible though
- ❷ This uses single quotes to protect the whole argument, hence actual single quotes need to be doubled
- ❸ But SpEL recognizes String literals with either single or double quotes, so this last method is arguably the best

Please note that the examples above are to be considered outside of the Spring XD shell. When entered inside the shell, chances are that the whole stream definition will itself be inside double quotes, which would need escaping. The whole example then becomes:

```
xd:>stream create foo --definition "http | filter --expression=payload='foo' | log"
xd:>stream create foo --definition "http | filter --expression='payload == 'foo'' | log"
xd:>stream create foo --definition "http | filter --expression='payload == \"foo\"' | log"
```

SpEL syntax and SpEL literals

The last piece of the puzzle is about SpEL expressions. Many modules accept options that are to be interpreted as SpEL expressions, and as seen above, String literals are handled in a special way there too. Basically,

- literals can be enclosed in either single or double quotes
- quotes need to be doubled to embed a literal quote. Single quotes inside double quotes need no special treatment, and *vice versa*

As a last example, assume you want to use the [transform](#) module. That module accepts an `expression` option which is a SpEL expression. It is to be evaluated against the incoming message, with a default of `payload` (which forwards the message payload untouched).

It is important to understand that the following are equivalent:

```
transform --expression=payload
transform --expression='payload'
```

but very different from the following:

```
transform --expression="'payload'"
transform --expression='\"payload\"'
```

and other variations.

The first series will simply evaluate to the message payload, while the latter examples will evaluate to the actual literal string `payload` (again, without quotes).

Putting it all together

As a last, complete example, let's review how one could force the transformation of all messages to the string literal `hello world`, by creating a stream in the context of the XD shell:

```
stream create foo --definition "http | transform --expression='\"hello world\"' | log" ❶
stream create foo --definition "http | transform --expression='\"hello world\"' | log" ❷
stream create foo --definition "http | transform --expression='\"hello world\"' | log" ❸
```

- ❶ This uses single quotes around the string (at the XD parser level), but they need to be doubled because we're inside a string literal (very first single quote after the equals sign)
- ❷❸ use single and double quotes respectively to encompass the whole string at the XD parser level. Hence, the other kind of quote can be used inside the string. The whole thing is inside the `--definition` argument to the shell though, which uses double quotes. So double quotes are escaped (at the shell level) `== Interactive Shell`

4.7 Introduction

Spring XD includes an interactive shell that you can use create, deploy, destroy and query streams and jobs. There are also commands to help with common tasks such as interacting with HDFS, the UNIX shell, and sending HTTP requests. In this section we will introduce the main commands and features of the shell.

Using the Shell

When you start the shell you can type `help` to show all the commands that are available. Note, that since the XD shell is based on [Spring Shell](#) you can contribute you own commands into the shell. The general groups of commands are related to the management of

- Modules
- Streams
- Jobs
- Analytics (Counters, Aggregate Counters, Gauges, etc.)
- HDFS

For example to see what modules are available issue the command

```
xd:>module list
```

Tip

The list of all Spring XD specific commands can be found in the [Shell Reference](#)

The shell also provides extensive command completion capabilities. For example, if you type `mod` and hit TAB, you will be presented with all the matching commands.

```
xd:>module
module compose    module delete    module display    module info
module list
```

Note

Tab completion works for module options as well as for the DSL used within the `--definition` option for stream and module commands.

The command `module list` shows all the modules available

```

xd:>module list
-----
Source           Processor        Sink             Job
-----
gemfire-cq       aggregator      counter          hdfsjdbc
post             http-client     log              jdbchdfs
twitterstream    splitter        field-value-counter  hdfsmongodb
http             filter          rich-gauge       filejdbc
reactor-syslog   json-to-tuple  mqtt             ftphdfs
reactor-ip       transform       file             filepollhdfs
jms              bridge          splunk
tcp-client       object-to-json  mail
mqtt             script          tcp
file             hdfs
twittersearch    gauge
gemfire          jdbc
mail             gemfire-server
trigger          throughput-sampler
tcp              gemfire-json-server
tail             router
syslog-tcp       aggregate-counter
syslog-udp       rabbit
rabbit           hdfs-dataset
time

```

Suppose we want to create a stream that uses the `http` source and `file` sink. How do we know what options are available to use? There are two ways to find out. The first is to use the command `module info`. Pressing `TAB` after typing `module info` will complete the command with the `--name` option and then present all the modules prefixed by their type.

```

xd:>module info --name
job:filepollhdfs      job:ftphdfs
job:hdfsjdbc          job:jdbchdfs
processor:aggregator  processor:bridge      processor:filter
processor:http-client  processor:json-to-tuple  processor:object-to-json
processor:script       processor:splitter      processor:transform
sink:aggregate-counter  sink:counter          sink:field-value-counter
sink:file              sink:gauge             sink:gemfire-json-server
sink:gemfire-server    sink:hdfs              sink:hdfs-dataset
sink:jdbc              sink:log               sink:mail
sink:mqtt              sink:rabbit            sink:rich-gauge
sink:router            sink:splunk            sink:tcp
sink:throughput-sampler  source:file            source:gemfire
source:gemfire-cq       source:http            source:jms
source:mail            source:mqtt            source:post
source:rabbit           source:reactor-ip      source:reactor-syslog
source:syslog-tcp       source:syslog-udp      source:tail
source:tcp              source:tcp-client      source:time
source:trigger          source:twittersearch    source:twitterstream
xd:>module info --name

```

The module `info` command for the `http` source shows the option names, a brief description, and default values.

```

xd:>module info --name source:http
Information about source module 'http':

Option Name  Description                                     Default  Type
-----
port         the port to listen to                           9000     int
outputType   how this module should emit messages it produces <none>   MimeType

```

For the `file` sink the options are

```

xd:>module info --name sink:file
Information about sink module 'file':

  Option Name  Description                                     Default
  Type
  -----
  binary       if false, will append a newline character at the end of each line  false
boolean
  charset      the charset to use when writing a String payload                       UTF-8
String
  dir          the directory in which files will be created                          /tmp/xd/output/
String
  mode         what to do if the file already exists                                  APPEND
Mode
  name         filename pattern to use                                               ${xd.stream.name}
String
  suffix       filename extension to use                                             <none>
String
  inputType    how this module should interpret messages it consumes                 <none>
MimeType

```

Note that the default value `${xd.stream.name}` will be resolved to the name of the stream that contains the module.

Tab completion for Job and Stream DSL definitions

When creating a stream definition tab completion after `--definition` will enable you to see all the options that are available for a given module as well as a list of candidate modules for the subsequent module in the stream. For example, hitting `TAB` after `http` as shown below

```

xd:>stream create --name test --definition "http
http --outputType=      http --port=          http | aggregate-counter    http | aggregator
http | bridge           http | counter          http | field-value-counter  http | file
http | filter           http | gauge            http | gemfire-json-server  http | gemfire-
server
http | hdfs             http | hdfs-dataset     http | http-client          http | jdbc
http | json-to-tuple    http | log              http | mail                 http | mqtt
http | object-to-json   http | rabbit           http | rich-gauge           http | router
http | script           http | splitter         http | splunk               http | tcp
http | throughput-sampler http | transform

```

shows the options `outputType` and `port` in addition to any processors and sinks. Hitting `TAB` after entering `--` after the `http` module will provide a list of only the `http` options

```

xd:>stream create --name test --definition "http --
http --outputType=  http --port=

```

Entering the port number and also the pipe `|` symbol and hitting `tab` will show completions for candidate processor and sink modules. The same process of tab completion for module options applies to each module in the chain.

Executing a script

You can execute a script by either passing in the `--cmdfile` argument when starting the shell or by executing the `script` command inside the shell. When using scripts it is common to add comments using either `//` or `;` characters at the start of the line for one line comments or use `/*` and `*/` for multiline comments

Single quotes, Double quotes, Escaping

There are often three layers of parsing when passing entering commands to the shell. The shell parses the command to recognize -- options, inside the body of a stream/job definition the values are parsed until the first space character, and inside some command options SpEL is used (e.g. router). Understanding the interaction between these layers can cause some confusion. The DSL Guide section [on quotes and escaping](#) will help you if you run into any issues.

5. Admin UI

5.1 Introduction

Spring XD provides a browser-based GUI which currently has 2 sections allowing you to

- perform Batch Job related tasks
- deploy/undeploy Stream Definitions

Upon starting Spring XD, the Admin UI is available at:

"http://<adminHost>:<adminPort>/admin-ui"

For example: <http://localhost:9393/admin-ui>

If you have enabled https, then it will be located at <https://localhost:9393/admin-ui>

If you have enabled security, a login form is available at <http://localhost:9393/admin-ui/login>

Note: Default admin server port is 9393

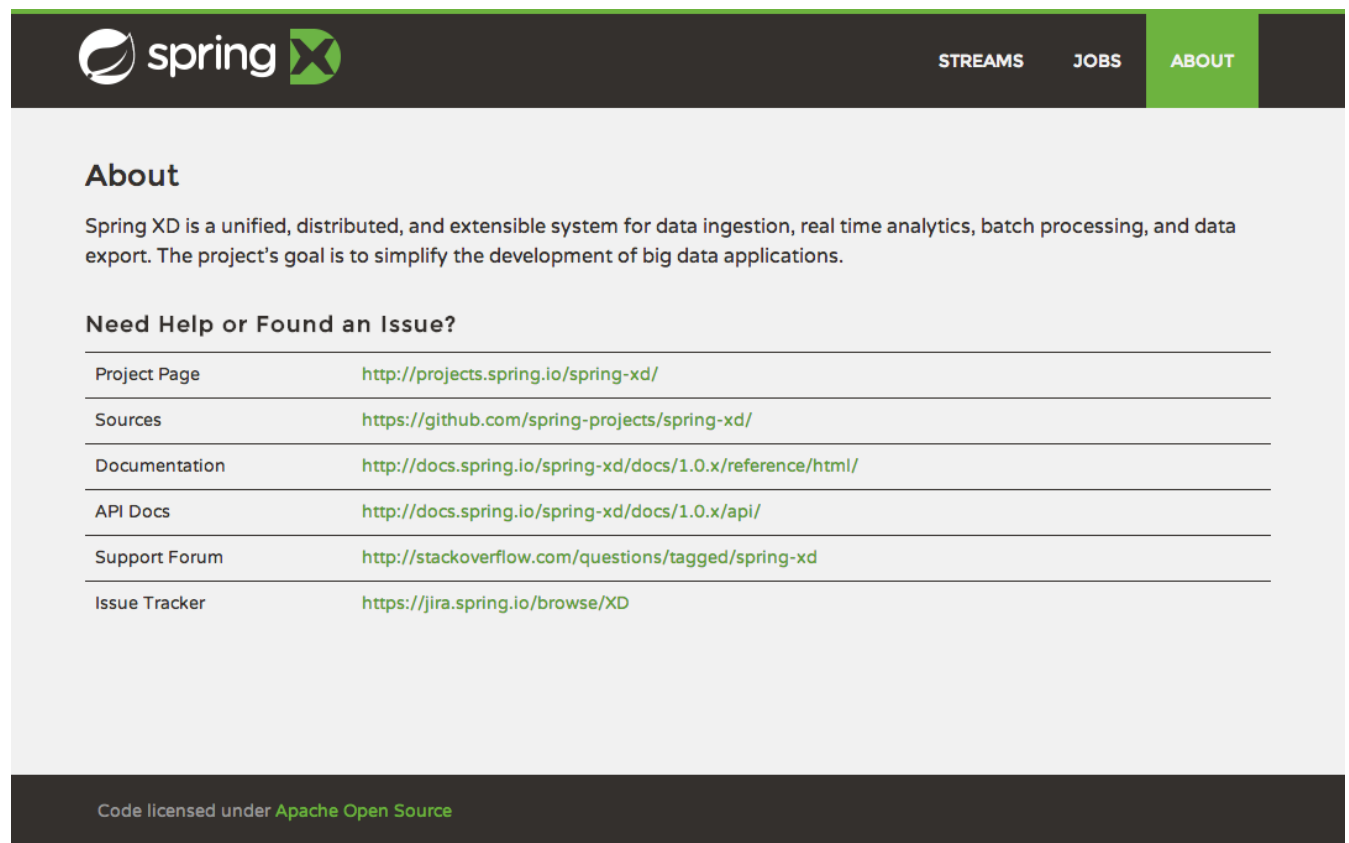

Figure 5.1. The Spring XD Admin UI

5.2 Containers

The *Containers* section of the admin UI shows the containers that are in the XD cluster. For each container the group properties and deployed modules are shown. More information on the container (hostname, pid, ip address) and for the module (module options and deployment properties) is available

by clicking on the respective links. You can also shutdown a container (in distributed mode) by clicking on the shutdown button. You will be asked for confirmation if you select to shutdown.

Cluster view

This section shows the XD cluster view with the list of all running containers. To enable actions on the containers, make sure to **enable** the management port.

Containers

Quick filter

Container Id	Groups	Deployed Modules	Action
ab8c6c47-1873-42c4-9de5-f70e8313b7c5	N/A	ticktock log.1 ticktock time.1	Shutdown

Figure 5.2. List of Containers

5.3 Streams

The *Streams* section of the admin UI provides the *Definitions* tab that provides a listing of Stream definitions. There you have the option to **deploy** or **undeploy** those streams. Additionally you can remove the definition by clicking on **destroy**.

Streams

This section lists all the stream definitions and provides the ability to **deploy/undeploy** or **destroy** streams.

Definitions

Quick filter

Name	Definition	Actions
ticktock	time log	Undeploy Deploy Destroy
wordCountFiles	file --ref=true > queue:job:wordCountJob	Undeploy Deploy Destroy

Code licensed under [Apache Open Source](#)

Figure 5.3. List of Stream Definitions

5.4 Jobs

The *Jobs* section of the admin UI currently has four tabs specific for **Batch Jobs**

- Modules
- Definitions
- Deployments
- Executions

Modules

Modules encapsulate a unit of work into a reusable component. Within the XD runtime environment Modules allow users to create definitions for *Streams* as well as *Batch Jobs*. Consequently, the *Modules* tab within the *Jobs* section allows users to create *Batch Job* definitions. In order to learn more about *Modules*, please see the chapter on [Modules](#).

List available batch job modules

This page lists the available batch job modules.

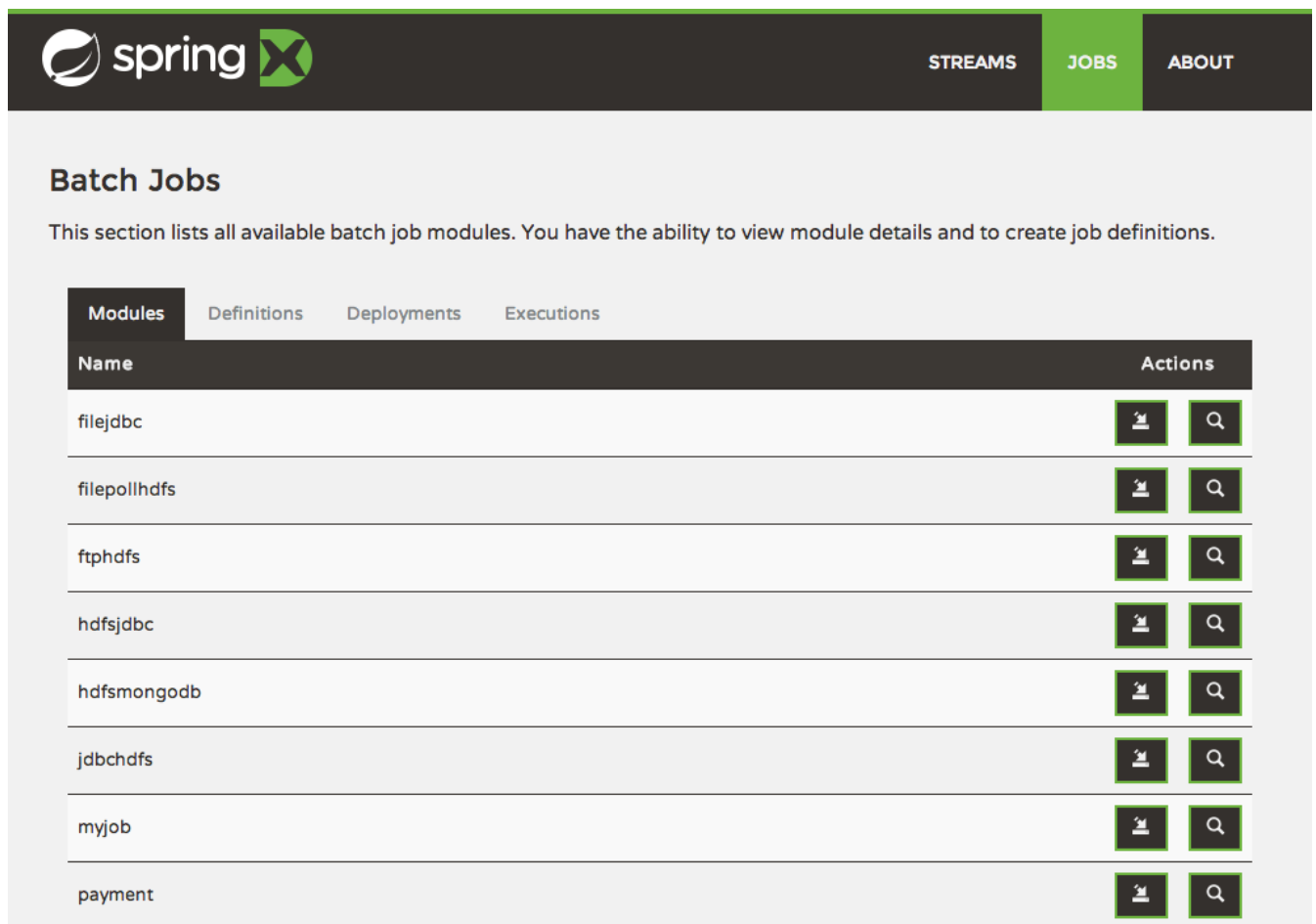



















Name	Actions
filejdbc	 
filepollhdfs	 
ftphdfs	 
hdfsjdbc	 
hdfsmongodb	 
jdbchdfs	 
myjob	 
payment	 

Figure 5.4. List Job Modules

On this screen you can perform the following actions:

	View details such as the job module options.
	Create a Job Definition from the respective Module.

Create a Job Definition from a selected Job Module

On this screen you can create a new Job Definition. As a minimum you must provide a name for the new definition. Optionally you can select whether the new definition shall be automatically deployed. Depending on the selected module, you will also have the option to specify various parameters that are used during the deployment of the definition.

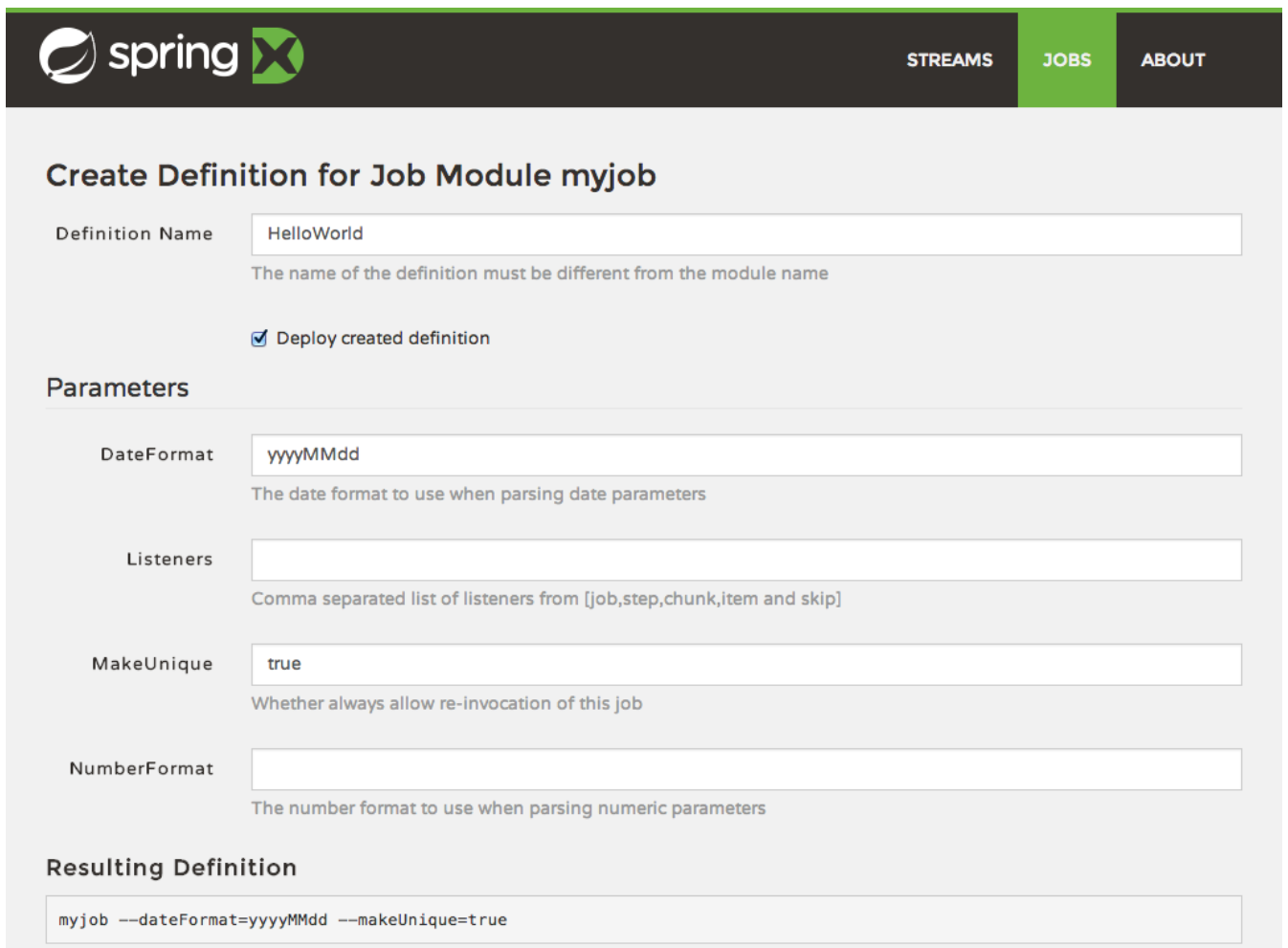

spring X STREAMS **JOBS** ABOUT

Create Definition for Job Module myjob

Definition Name
The name of the definition must be different from the module name

Deploy created definition

Parameters

DateFormat
The date format to use when parsing date parameters

Listeners
Comma separated list of listeners from [job,step,chunk,item and skip]

MakeUnique
Whether always allow re-invocation of this job

NumberFormat
The number format to use when parsing numeric parameters

Resulting Definition

```
myjob --dateFormat=yyyyMMdd --makeUnique=true
```

Figure 5.5. Create a Job Definition

View Job Module Details

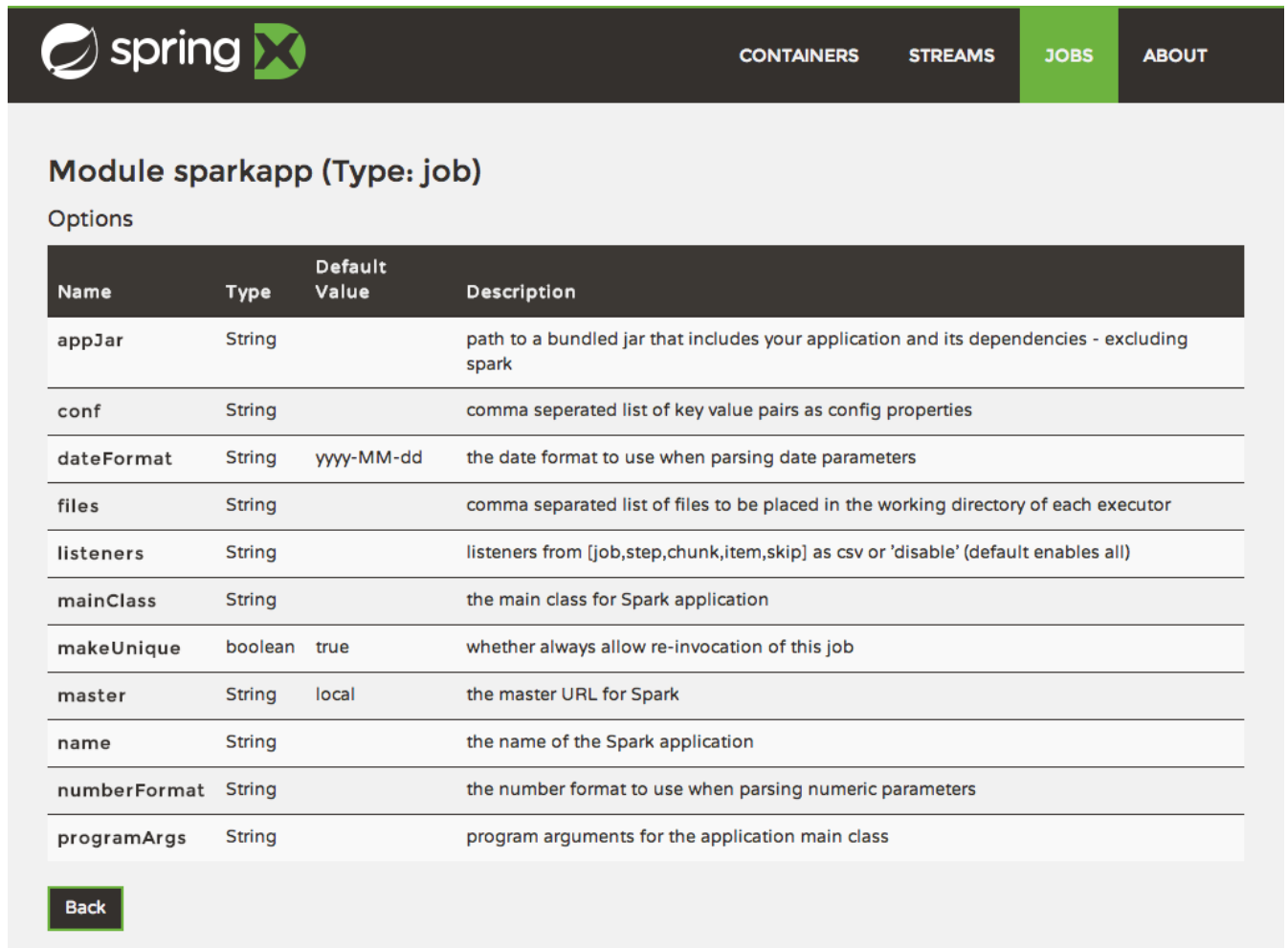

The screenshot shows the 'View Job Module Details' page for a Spark application. The page has a dark header with the Spring XD logo and navigation tabs for 'CONTAINERS', 'STREAMS', 'JOBS', and 'ABOUT'. The 'JOBS' tab is active. Below the header, the page title is 'Module sparkapp (Type: job)'. Underneath, there is a section titled 'Options' which contains a table listing various configuration properties for the Spark application.

Name	Type	Default Value	Description
appJar	String		path to a bundled jar that includes your application and its dependencies - excluding spark
conf	String		comma seperated list of key value pairs as config properties
dateFormat	String	yyyy-MM-dd	the date format to use when parsing date parameters
files	String		comma separated list of files to be placed in the working directory of each executor
listeners	String		listeners from [job,step,chunk,item,skip] as csv or 'disable' (default enables all)
mainClass	String		the main class for Spark application
makeUnique	boolean	true	whether always allow re-invocation of this job
master	String	local	the master URL for Spark
name	String		the name of the Spark application
numberFormat	String		the number format to use when parsing numeric parameters
programArgs	String		program arguments for the application main class

At the bottom of the options section, there is a 'Back' button.

Figure 5.6. View Job Module Details

On this page you can view the details of a selected job module. The page lists the available options (properties) of the modules.

List job definitions

This page lists the XD batch job definitions and provides actions to **deploy**, **un-deploy** or **destroy** those jobs.

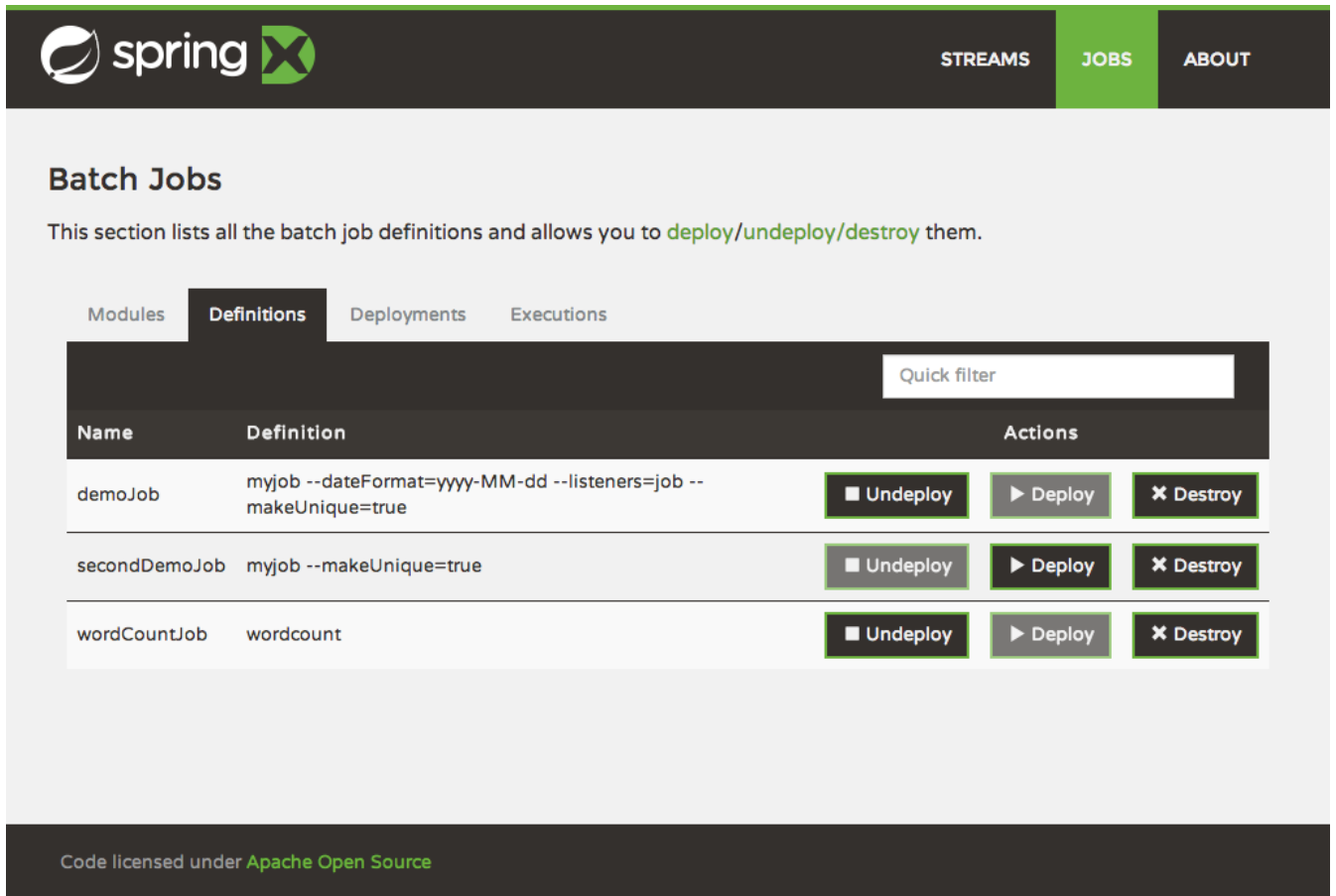

The screenshot shows the Spring XD web interface. At the top, there is a navigation bar with the Spring logo and 'spring X' text on the left, and 'STREAMS', 'JOBS', and 'ABOUT' links on the right. The 'JOBS' link is highlighted in green. Below the navigation bar, the page title is 'Batch Jobs'. A sub-header states: 'This section lists all the batch job definitions and allows you to [deploy/undeploy/destroy](#) them.' Below this, there are four tabs: 'Modules', 'Definitions', 'Deployments', and 'Executions'. The 'Definitions' tab is selected. A 'Quick filter' input field is located at the top right of the table area. The table has three columns: 'Name', 'Definition', and 'Actions'. It lists three job definitions: 'demoJob', 'secondDemoJob', and 'wordCountJob'. Each row has three action buttons: 'Undeploy', 'Deploy', and 'Destroy'.

Name	Definition	Actions
demoJob	myjob --dateFormat=yyyy-MM-dd --listeners=job --makeUnique=true	Undeploy Deploy Destroy
secondDemoJob	myjob --makeUnique=true	Undeploy Deploy Destroy
wordCountJob	wordcount	Undeploy Deploy Destroy

Code licensed under [Apache Open Source](#)

Figure 5.7. List Job Definitions

List job deployments

This page lists all the deployed jobs and provides option to **launch** or **schedule** the deployed job.

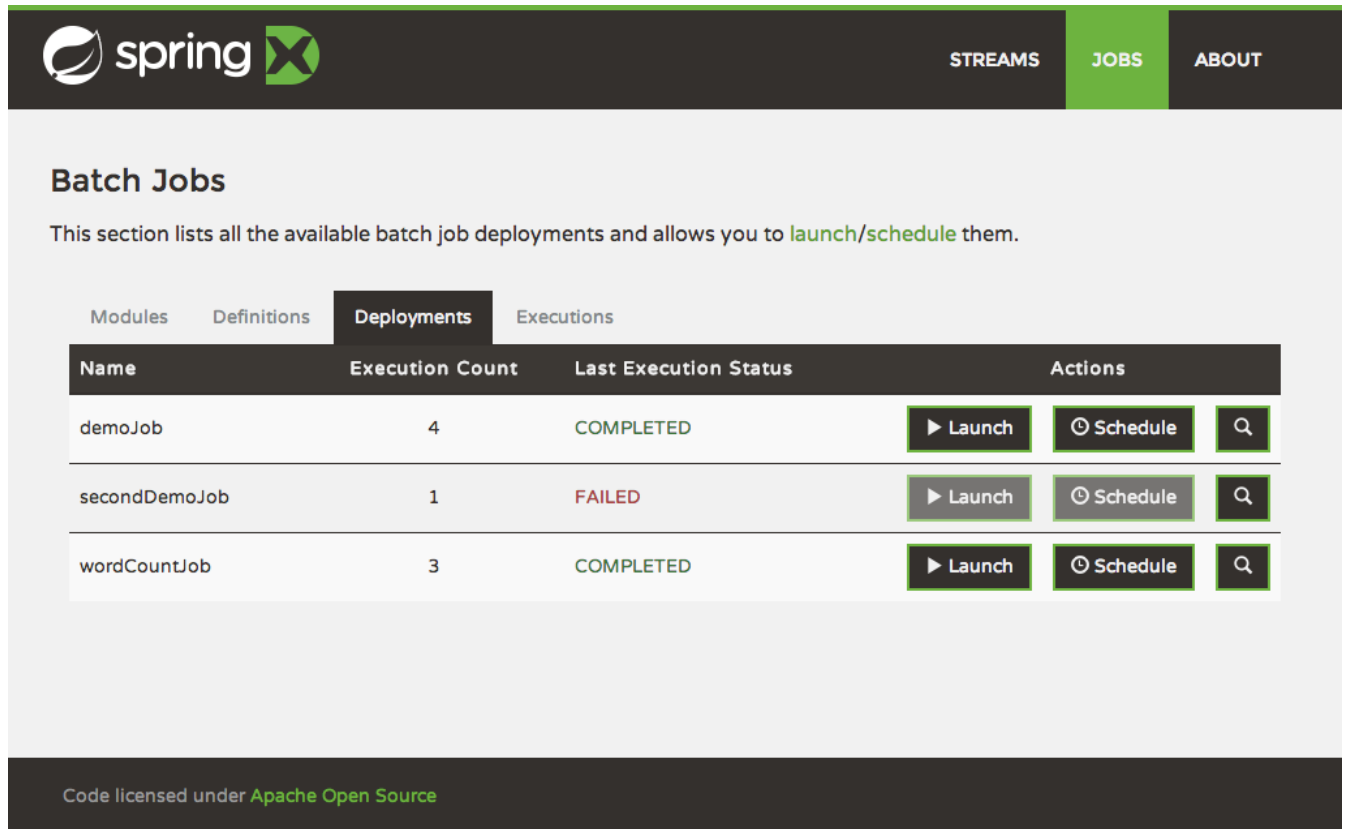

Batch Jobs

This section lists all the available batch job deployments and allows you to [launch/schedule](#) them.

Modules Definitions **Deployments** Executions

Name	Execution Count	Last Execution Status	Actions
demoJob	4	COMPLETED	▶ Launch ⌚ Schedule 🔍
secondDemoJob	1	FAILED	▶ Launch ⌚ Schedule 🔍
wordCountJob	3	COMPLETED	▶ Launch ⌚ Schedule 🔍

Code licensed under [Apache Open Source](#)

Figure 5.8. List Job Deployments

Launching a batch Job

Once the job is deployed, they can be launched through the Admin UI as well. Navigate to the **Deployments** tab. Select the job you want to launch and press `Launch`. The following modal dialog should appear:

Batch Jobs

This section lists all the available batch job deployments and allows you to [launch/schedule](#) them.

Modules Definitions **Deployments** Executions

Name	Launch	Schedule	Execution Count	Last Execution Status
HelloWorldJob	▶ Launch	⌚ Schedule	2	FAILED
wordCountJob	▶ Launch	⌚ Schedule	3	COMPLETED

Launch - Job Parameters for wordCountJob

✕
 Identifying

[+ Param](#)Close [Launch Job ▶](#)

Code licensed under [Apache Open Source](#)

Figure 5.9. Launch a Batch Job with parameters

Using this screen, you can define one or more job parameters. Job parameters can be typed and the following data types are available:

- String (The default)
- Date (The default date format is: `yyyy/MM/dd`)
- Long
- Double

Schedule Batch Job Execution

Batch Jobs

This section lists all the available batch job deployments and allows you to [launch/schedule](#) them.

Modules Definitions **Deployments** Executions

Name	Launch	Schedule	Execution Count	Last Execution Status
HelloWorldJob	▶ Launch	⌚ Schedule	2	FAILED
wordCountJob	▶ Launch	⌚ Schedule	3	COMPLETED

Scheduling job wordCountJob

Scheduler (Stream) Name

Fixed delay

Date

Cron

[Close](#) [Schedule Job ▶](#)

Figure 5.10. Schedule a Batch Job

When clicking on **Schedule**, you have the option to run the job:

- using a fixed delay interval (specified in seconds)
- on a specific data/time
- using a valid CRON expression

Job Deployment Details

On this screen, you can view additional deployment details. Besides viewing the stream definition, the available Module Metadata is shown as well, e.g. on which Container the definition has been deployed to.

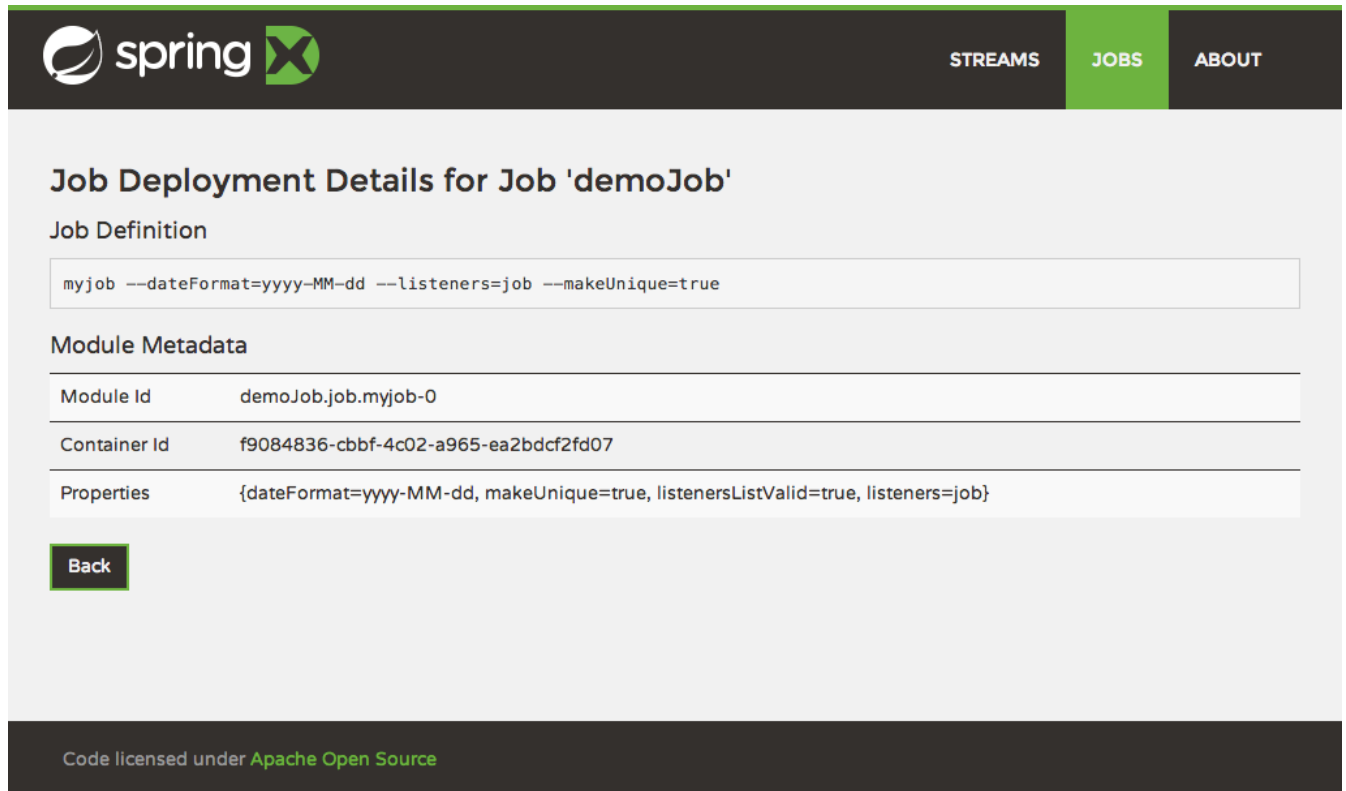

The screenshot shows the 'Job Deployment Details for Job 'demoJob'' page. At the top, there is a navigation bar with the Spring XD logo and three menu items: 'STREAMS', 'JOBS' (which is highlighted in green), and 'ABOUT'. Below the navigation bar, the page title is 'Job Deployment Details for Job 'demoJob''. Underneath, there is a section for 'Job Definition' containing a code block with the command: `myjob --dateFormat=yyyy-MM-dd --listeners=job --makeUnique=true`. This is followed by a 'Module Metadata' section, which is a table with three rows: 'Module Id' with value 'demoJob.job.myjob-0', 'Container Id' with value 'f9084836-cbbf-4c02-a965-ea2bdcf2fd07', and 'Properties' with value '{dateFormat=yyyy-MM-dd, makeUnique=true, listenersListValid=true, listeners=job}'. Below the table is a 'Back' button. At the bottom of the page, there is a footer that says 'Code licensed under [Apache Open Source](#)'.

Module Metadata	
Module Id	demoJob.job.myjob-0
Container Id	f9084836-cbbf-4c02-a965-ea2bdcf2fd07
Properties	{dateFormat=yyyy-MM-dd, makeUnique=true, listenersListValid=true, listeners=job}

Figure 5.11. Job Deployment Details

List job executions

This page lists the batch job executions and provides option to **restart** specific job executions, provided the batch job is restartable and stopped/failed.

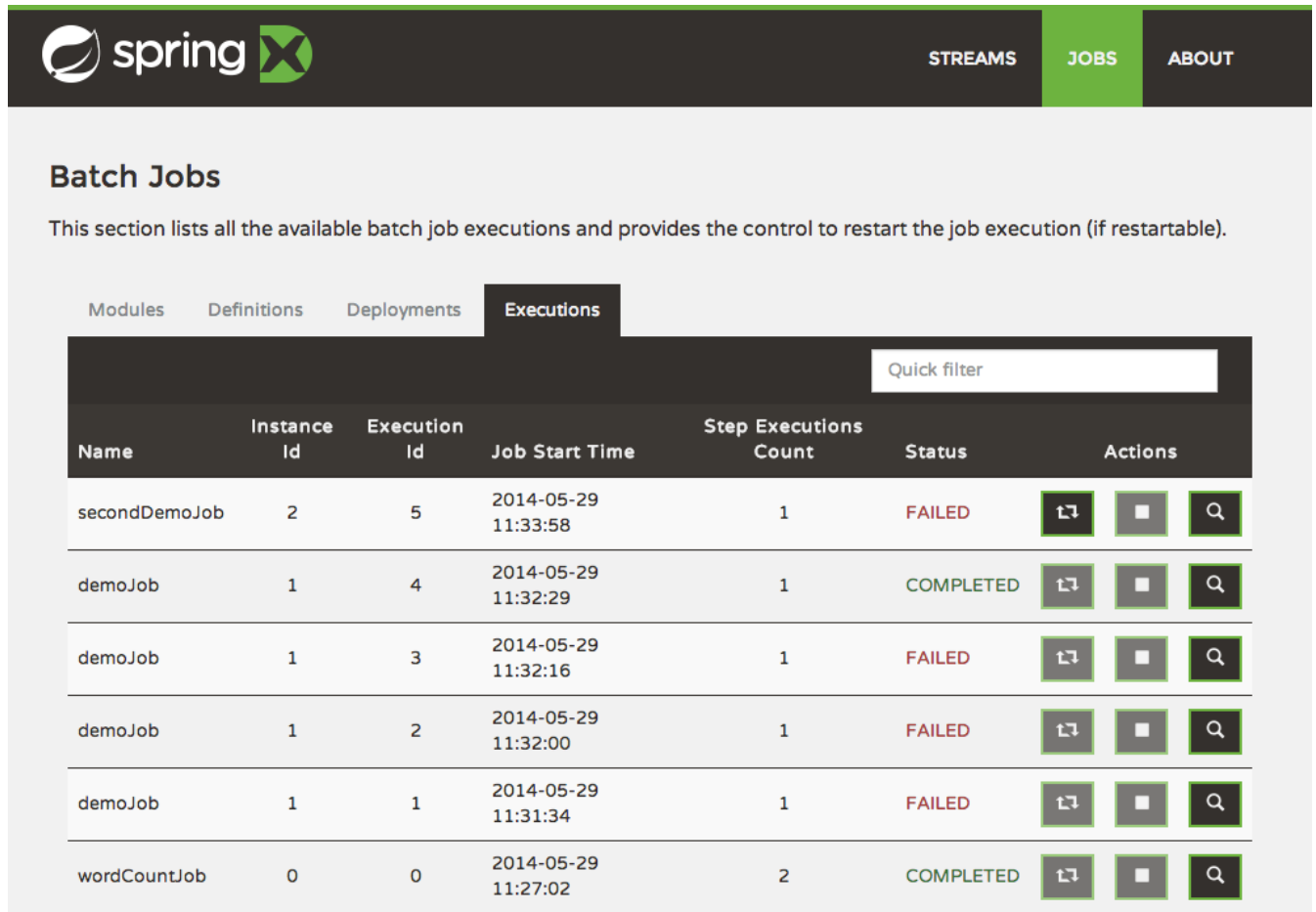

The screenshot shows the Spring XD Jobs page. At the top, there is a navigation bar with the Spring XD logo and three tabs: STREAMS, JOBS (which is active), and ABOUT. Below the navigation bar, the page title is "Batch Jobs". A sub-header states: "This section lists all the available batch job executions and provides the control to restart the job execution (if restartable)."

Below the sub-header, there are four tabs: Modules, Definitions, Deployments, and Executions (which is active). A "Quick filter" input field is located to the right of the Executions tab.

The main content is a table with the following columns: Name, Instance Id, Execution Id, Job Start Time, Step Executions Count, Status, and Actions. The table contains six rows of job execution data.

Name	Instance Id	Execution Id	Job Start Time	Step Executions Count	Status	Actions
secondDemoJob	2	5	2014-05-29 11:33:58	1	FAILED	[Restart] [Stop] [View]
demoJob	1	4	2014-05-29 11:32:29	1	COMPLETED	[Restart] [Stop] [View]
demoJob	1	3	2014-05-29 11:32:16	1	FAILED	[Restart] [Stop] [View]
demoJob	1	2	2014-05-29 11:32:00	1	FAILED	[Restart] [Stop] [View]
demoJob	1	1	2014-05-29 11:31:34	1	FAILED	[Restart] [Stop] [View]
wordCountJob	0	0	2014-05-29 11:27:02	2	COMPLETED	[Restart] [Stop] [View]

Figure 5.12. List Job Executions

Furthermore, you have the option to view the Job execution details.

Job execution details

The screenshot shows the Spring XD interface with the 'JOBS' tab selected. The main heading is 'Job Execution Details - Execution ID: 4'. Below this is a table with the following data:

Property	Value
Id	4
Job Name	HelloWorldJob
Job Instance	3
Job Parameters	random=0.644669600095795,-throwError=true
Start Date	2014-05-15
Start Time	22:15:28 (America/New_York)
Duration	00:00:01
Status	FAILED
Exit Code	FAILED
Exit Message	N/A
Step Execution Count	1

Figure 5.13. Job Execution Details

The same screen also contains a list of the executed steps:

The screenshot shows the 'Steps' section of the job execution details. It contains a table with the following data:

Step Id	Step Name	Reads	Writes	Commits	Rollbacks	Duration	Status	Details
4	import	0	0	1	0	481 ms	COMPLETED	
5	wordcount	836	2988	1	0	24503 ms	COMPLETED	

Below the table is a 'Back' button.

Code licensed under [Apache Open Source](#)

Figure 5.14. Job Execution Details - Steps

From there you can drill deeper into the *Step Execution Details*.

Step execution details

On the top of the page, you will see progress indicator the respective step, with the option to refresh the indicator. Furthermore, a link is provided to view the *step execution history*.

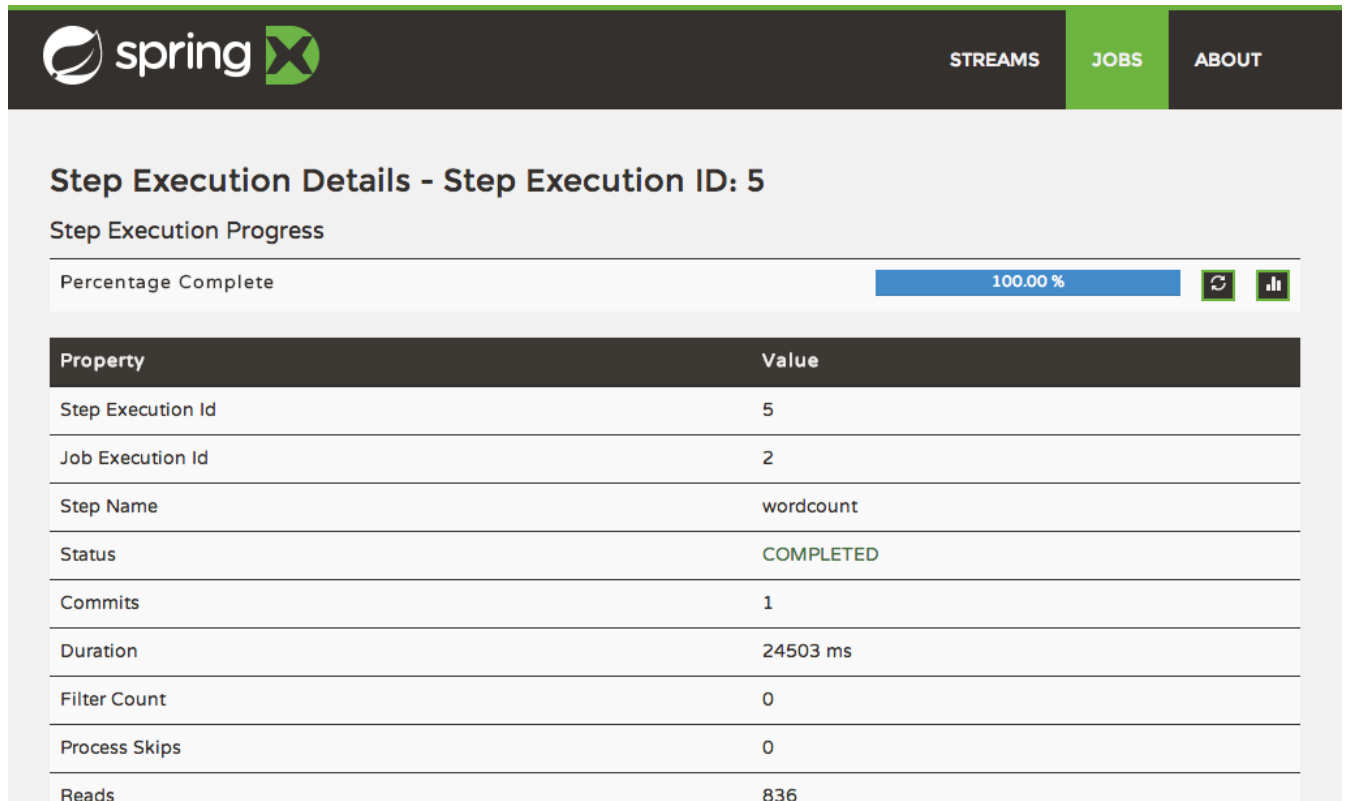



Figure 5.15. Step Execution Details

The Step Execution details screen provides a complete list of all Step Execution Context key/value pairs. For example, the *Spring for Apache Hadoop* steps provides exhaustive detail information.

Job Status::ID	job_1400191378494_0003
Job Status::Name	scopedTarget.wordcountJob
Job Status::State	SUCCEDED
Job Status::Tracking URL	http://INTEGRATION.local:8088/proxy/application_1400191378494_0003/
Map-Reduce Framework::Combine input records	0
Map-Reduce Framework::Combine output records	0
Map-Reduce Framework::CPU time spent (ms)	0
Map-Reduce Framework::Failed Shuffles	0
Map-Reduce Framework::GC time elapsed (ms)	36
Map-Reduce Framework::Input split bytes	119
Map-Reduce Framework::Map input records	836
Map-Reduce Framework::Map output bytes	84813
Map-Reduce Framework::Map output materialized bytes	101605
Map-Reduce Framework::Map output records	8393
Map-Reduce Framework::Merged Map outputs	1
Map-Reduce Framework::Physical memory (bytes) snapshot	0
Map-Reduce Framework::Reduce input groups	2988

Figure 5.16. Step Execution Context

This includes a link back to the *Job History UI* of the Hadoop Cluster.



Logged in as: dr.who

MapReduce Job

job_1400191378494_0002

▸ Application

▾ Job

- [Overview](#)
- [Counters](#)
- [Configuration](#)
- [Map tasks](#)
- [Reduce tasks](#)

▸ Tools

Job Overview

Job Name: scopedTarget.wordcountJob

User Name: hillert

Queue: default

State: SUCCEDED

Uberized: false

Started: Thu May 15 22:09:22 EDT 2014

Finished: Thu May 15 22:09:38 EDT 2014

Elapsed: 15sec

Diagnostics:

Average Map Time: 5sec

Average Reduce Time: 0sec

Average Shuffle Time: 4sec

Average Merge Time: 0sec

ApplicationMaster			
Attempt Number	Start Time	Node	Logs
1	Thu May 15 22:09:18 EDT 2014	10.0.1.4:8042	logs

Task Type	Total	Complete
Map	1	1
Reduce	1	1

Attempt Type	Failed	Killed	Successful
Maps	0	0	1
Reduces	0	0	1

Figure 5.17. Job History UI

Important

In case of exceptions, the *Exit Description* field will contain additional error information. Please be aware, though, that this field can only have a maximum of **2500 characters**. Therefore, in case of long exception stacktraces, trimming of error messages may occur. In that case, please refer to the server log files for further details.

Step execution history

Figure 5.18. Step Execution History

On this screen, you can view various metrics associated with the selected step such as **duration**, **read counts**, **write counts** etc.

6. Architecture

6.1 Introduction

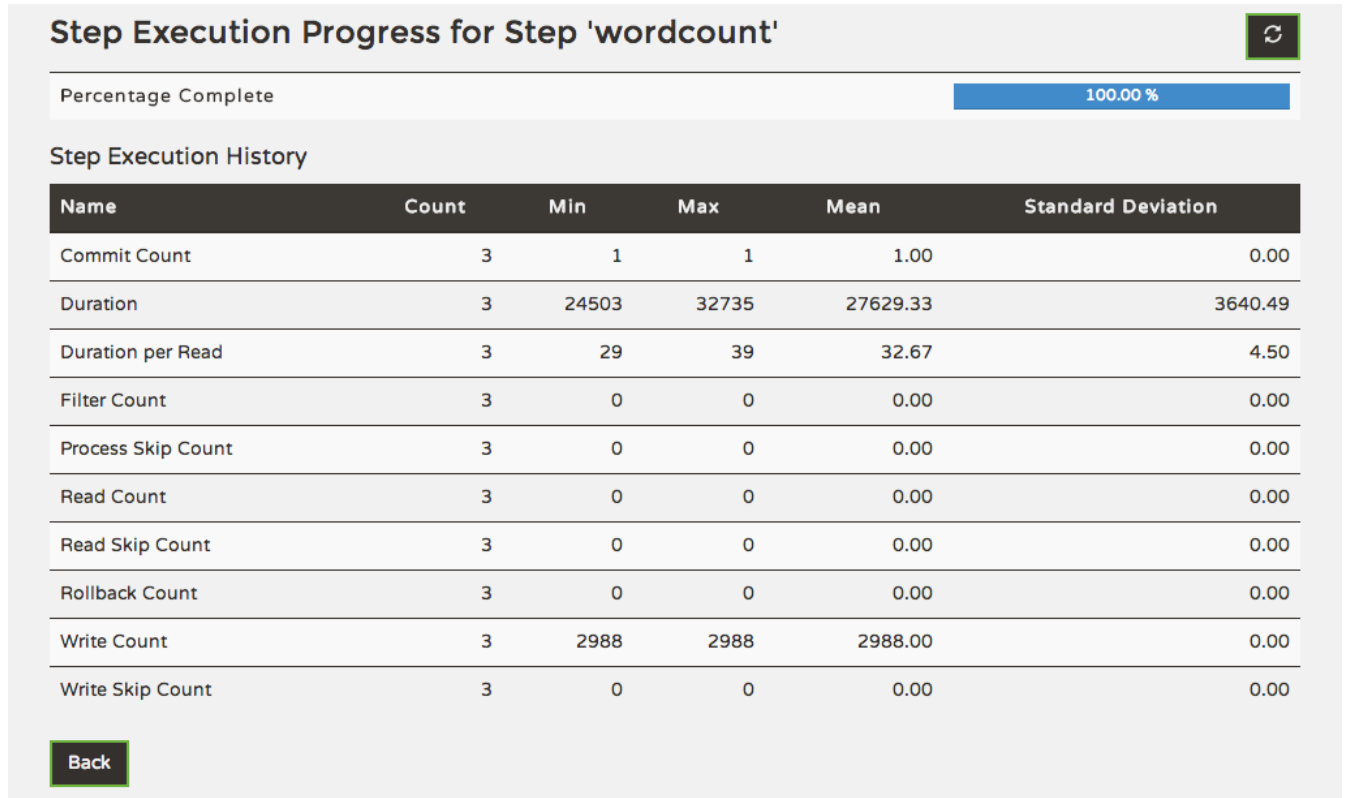
Spring XD is a unified, distributed, and extensible service for data ingestion, real time analytics, batch processing, and data export. The foundations of XD's architecture are based on the over 100+ man years of work that have gone into the Spring Batch, Integration and Data projects. Building upon these projects, Spring XD provides servers and a configuration DSL that you can immediately use to start processing data. You do not need to build an application yourself from a collection of jars to start using Spring XD.

Spring XD has two modes of operation - single and multi-node. The first is a single process that is responsible for all processing and administration. This mode helps you get started easily and simplifies the development and testing of your application. The second is a distributed mode, where processing tasks can be spread across a cluster of machines and an administrative server reacts to user commands and runtime events managed within a shared runtime state to coordinate processing tasks executing on the cluster.

Runtime Architecture

The key components in Spring XD are the XD Admin and XD Container Servers. Using a high-level DSL, you post the description of the required processing tasks to the Admin server over HTTP. The Admin server then maps the processing tasks into processing modules. A module is a unit of execution and is implemented as a Spring ApplicationContext. A distributed runtime is provided that will assign modules to execute across multiple XD Container servers. A single XD Container server can run multiple modules. When using the single node runtime, all modules are run in a single XD Container and the XD Admin server is run in the same process.

DIRT Runtime

A distributed runtime, called Distributed Integration Runtime, aka DIRT, will distribute the processing tasks across multiple XD Container instances. The XD Admin server breaks up a processing task into individual module definitions and assigns each module to a container instance using ZooKeeper (see [XD Distributed Runtime](#)). Each container listens for module definitions to which it has been assigned and deploys the module, creating a Spring ApplicationContext to run it.

Modules share data by passing messages using a configured messaging middleware (Rabbit, Redis, or Local for single node). To reduce the number of hops across messaging middleware between them, multiple modules may be composed into larger deployment units that act as a single module. To learn more about that feature, refer to the [Composing Modules](#) section.

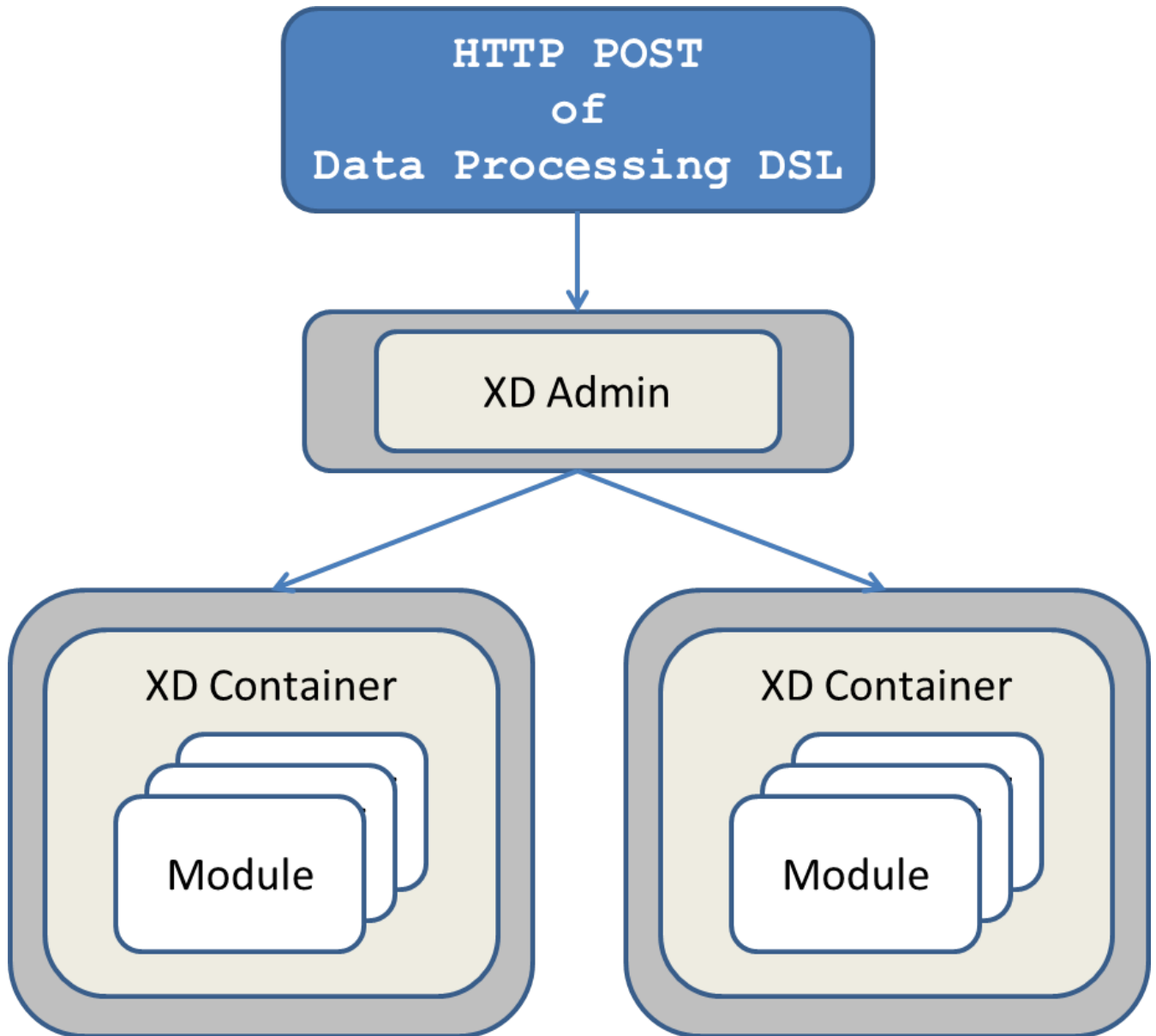

Figure 6.1. The XD Admin Server sending module definitions to each XD Container

How the processing task is broken down into modules is discussed in the section [Container Server Architecture](#).

Support for other distributed runtimes

In the 1.0 release, You can run Spring XD natively, in which case you are responsible for starting up the XD Admin and XD Container instances. Alternately you can run Spring XD on Hadoop's YARN, see [Running XD on YARN](#). Pivotal Cloud Foundry support is planned for a future release. If you are feeling a adventurous, you can also take a look at our scripts for [deploying Spring XD to EC2](#). These are used as part of our [system integration tests](#).

Single Node Runtime

A single node runtime is provided that runs the Admin and Container servers, ZooKeeper, and HSQLDB in the same process. the single node runtime is primarily intended for testing and development purposes but it may also appropriate to use in small production use-cases. The communication to the XD Admin

server is over HTTP and the XD Admin server communicates to an in-process XD Container using an embedded ZooKeeper server.

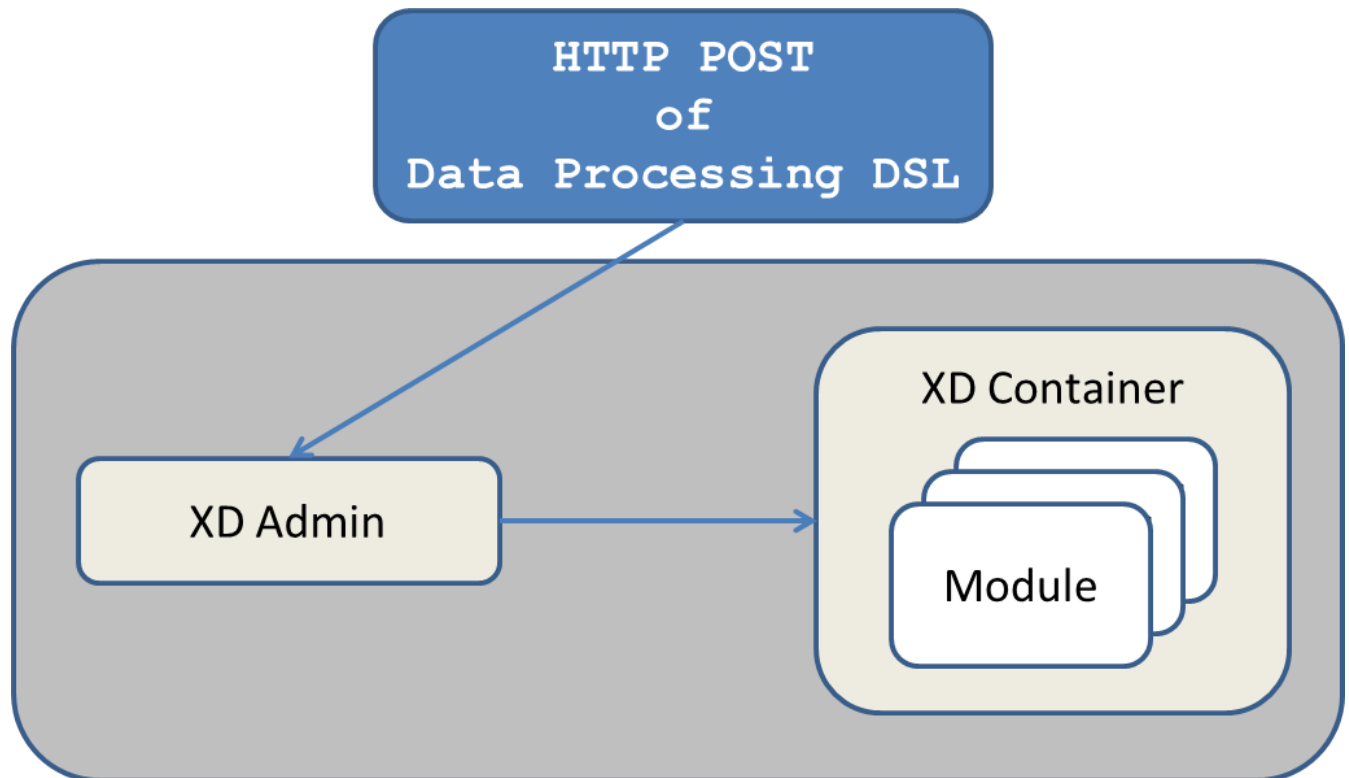

Figure 6.2. Single Node Runtime

Admin Server Architecture

The Admin Server uses an embedded servlet container and exposes REST endpoints for creating, deploying, undeploying, and destroying streams and jobs, querying runtime state, analytics, and the like. The Admin Server is implemented using Spring's MVC framework and the [Spring HATEOAS](#) library to create REST representations that follow the [HATEOAS](#) principle. The Admin Server and Container Servers monitor and update runtime state using ZooKeeper (see [XD Distributed Runtime](#)).

Container Server Architecture

The key components of data processing in Spring XD are

- Streams
- Jobs
- Taps

Streams define how event driven data is collected, processed, and stored or forwarded. For example, a stream might collect syslog data, filter, and store it in HDFS.

Jobs define how coarse grained and time consuming batch processing steps are orchestrated, for example a job could be defined to coordinate performing HDFS operations and the subsequent execution of multiple MapReduce processing tasks.

Taps are used to process data in a non-invasive way as data is being processed by a Stream or a Job. Much like wiretaps used on telephones, a Tap on a Stream lets you consume data at any point along

the Stream's processing pipeline. The behavior of the original stream is unaffected by the presence of the Tap.

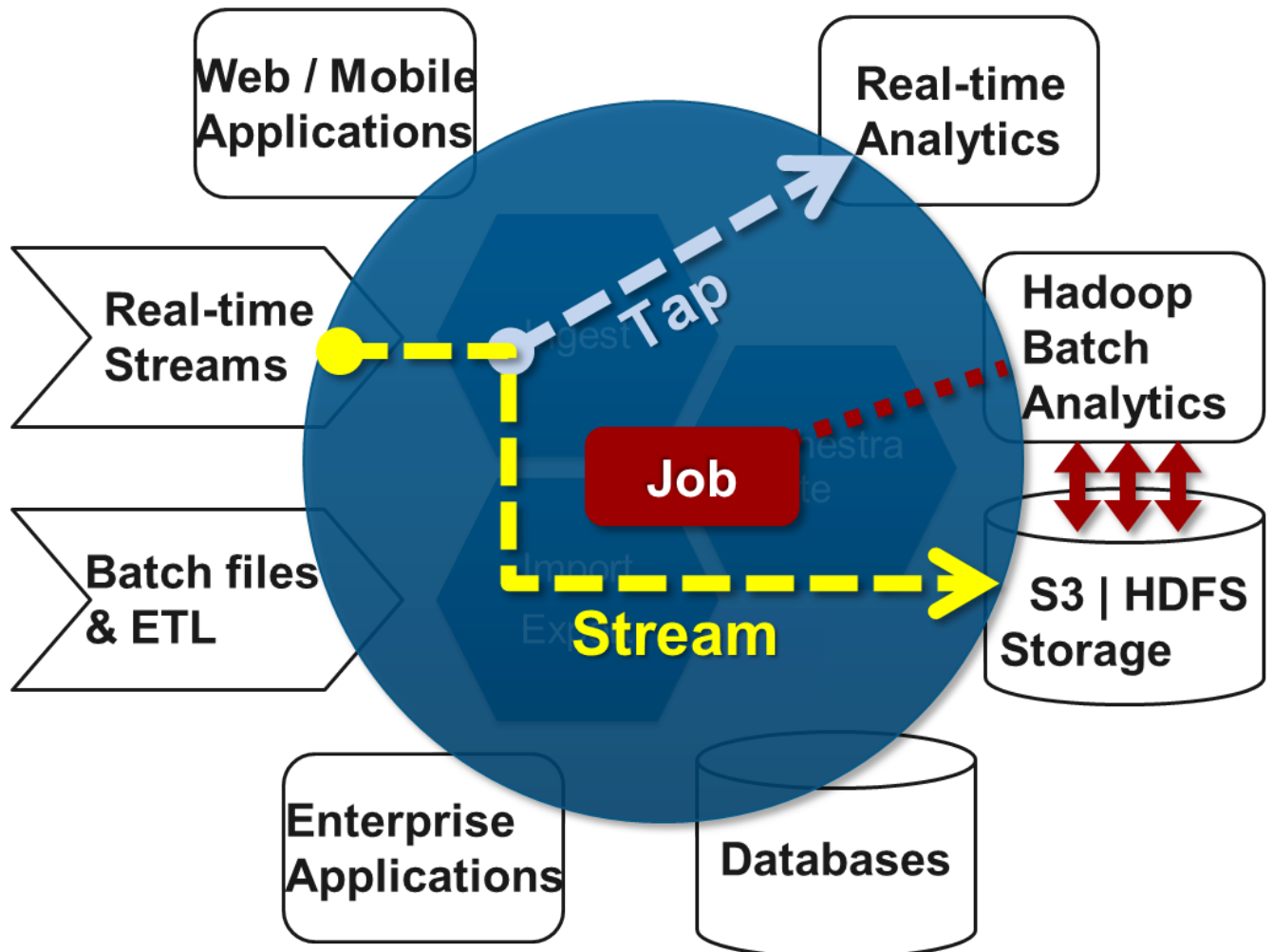

Figure 6.3. Taps, Jobs, and Streams

Streams

The programming model for processing event streams in Spring XD is based on the well known [Enterprise Integration Patterns](#) as implemented by components in the [Spring Integration](#) project. The programming model was designed so that it is easy to test components.

A Stream consist of the following types of modules: * An Input source * Processing steps * An Output sink

An Input source produces messages from an external source. XD supports a variety of sources, e.g. syslog, tcp, http. The output from a module is a Spring Message containing a payload of data and a collection of key-value headers. Messages flow through message channels from the source, through optional processing steps, to the output sink. The output sink delivers the message to an external resource. For example, it is common to write the message to a file system, such as HDFS, but you may also configure the sink to forward the message over tcp, http, or another type of middleware, or route the message to another stream.

A stream that consists of a input source and a output sink is shown below

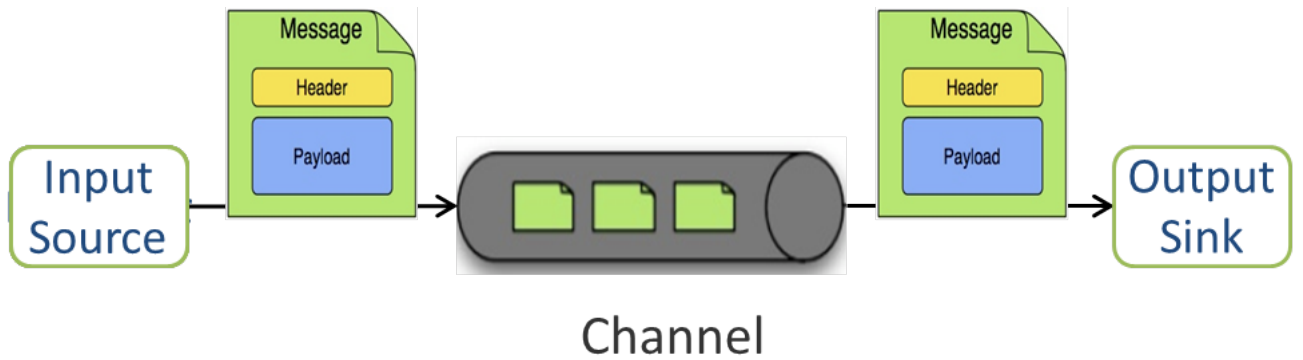

Figure 6.4. Foundational components of the Stream processing model

A stream that incorporates processing steps is shown below

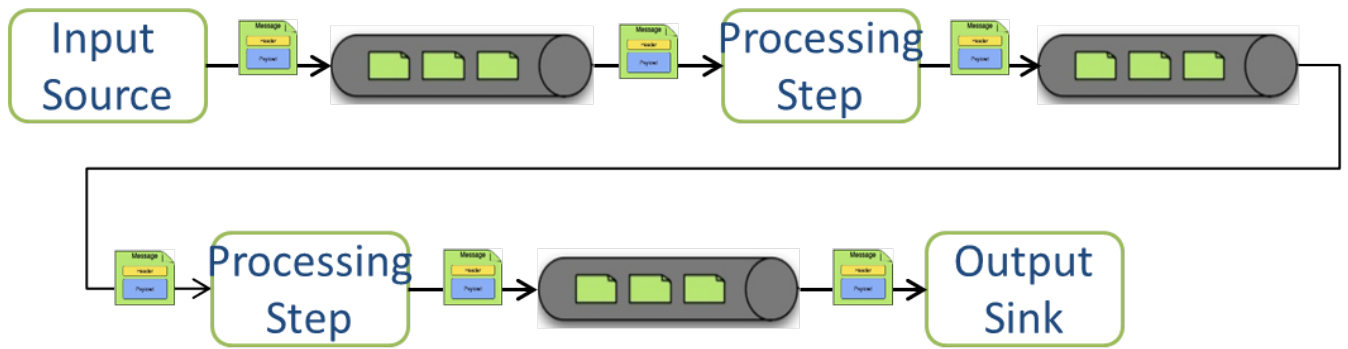

Figure 6.5. Stream processing with multiple steps

For simple linear processing streams, an analogy can be made with the UNIX pipes and filters model. Filters represent any component that produces, processes or consumes events. This corresponds to the modules (source, processing steps, and sink) in a stream. Pipes represent the way data is transported between the Filters. This corresponds to the Message Channel that moves data through a stream.

A simple stream definition using UNIX pipes and filters syntax that takes data sent via a HTTP post and writes it to a file (with no processing done in between) can be expressed as

```
http | file
```

The pipe symbol represents a message channel that passes data from the HTTP source to the File sink. The message channel implementation can either be backed with a local in-memory transport, Redis queues, or RabbitMQ. The message channel abstraction and the XD architecture are designed to support a pluggable data transport. Future releases will support other transports such as JMS.

Note that the UNIX pipes and filter syntax is the basis for the DSL that Spring XD uses to describe simple linear flows. Non-linear processing is partially supported using named channels which can be combined with a router sink to effectively split a single stream into multiple streams (see [Dynamic Router Sink](#)). Additional capabilities for non-linear processing are planned for future releases.

The programming model for processing steps in a stream originates from the Spring Integration project and is included in the core Spring Framework as of version 4. The central concept is one of a Message Handler class, which relies on simple coding conventions to Map incoming messages to processing

methods. For example, using an http source you can process the body of an HTTP POST request using the following class

```
public class SimpleProcessor {  
  
    public String process(String payload) {  
        return payload.toUpperCase();  
    }  
  
}
```

The payload of the incoming Message is passed as a string to the method `process`. The contents of the payload is the body of the http request as we are using a http source. The non-void return value is used as the payload of the Message passed to the next step. These programming conventions make it very easy to test your Processor component in isolation. There are several processing components provided in Spring XD that do not require you to write any code, such as a filter and transformer that use the Spring Expression Language or Groovy. For example, adding a processing step, such as a transformer, in a stream processing definition can be as simple as

```
http | transformer --expression=payload.toUpperCase() | file
```

For more information on processing modules, refer to the [Processors](#) section.

Stream Deployment

The Container Server listens for module deployment events initiated from the Admin Server via ZooKeeper. When the container node handles a module deployment event, it connects the module's input and output channels to the data bus used to transport messages during stream processing. In a single node configuration, the data bus uses in-memory direct channels. In a distributed configuration, the data bus communications are backed by the configured transport middleware. Redis and Rabbit are both provided with the Spring XD distribution, but other transports are envisioned for future releases.

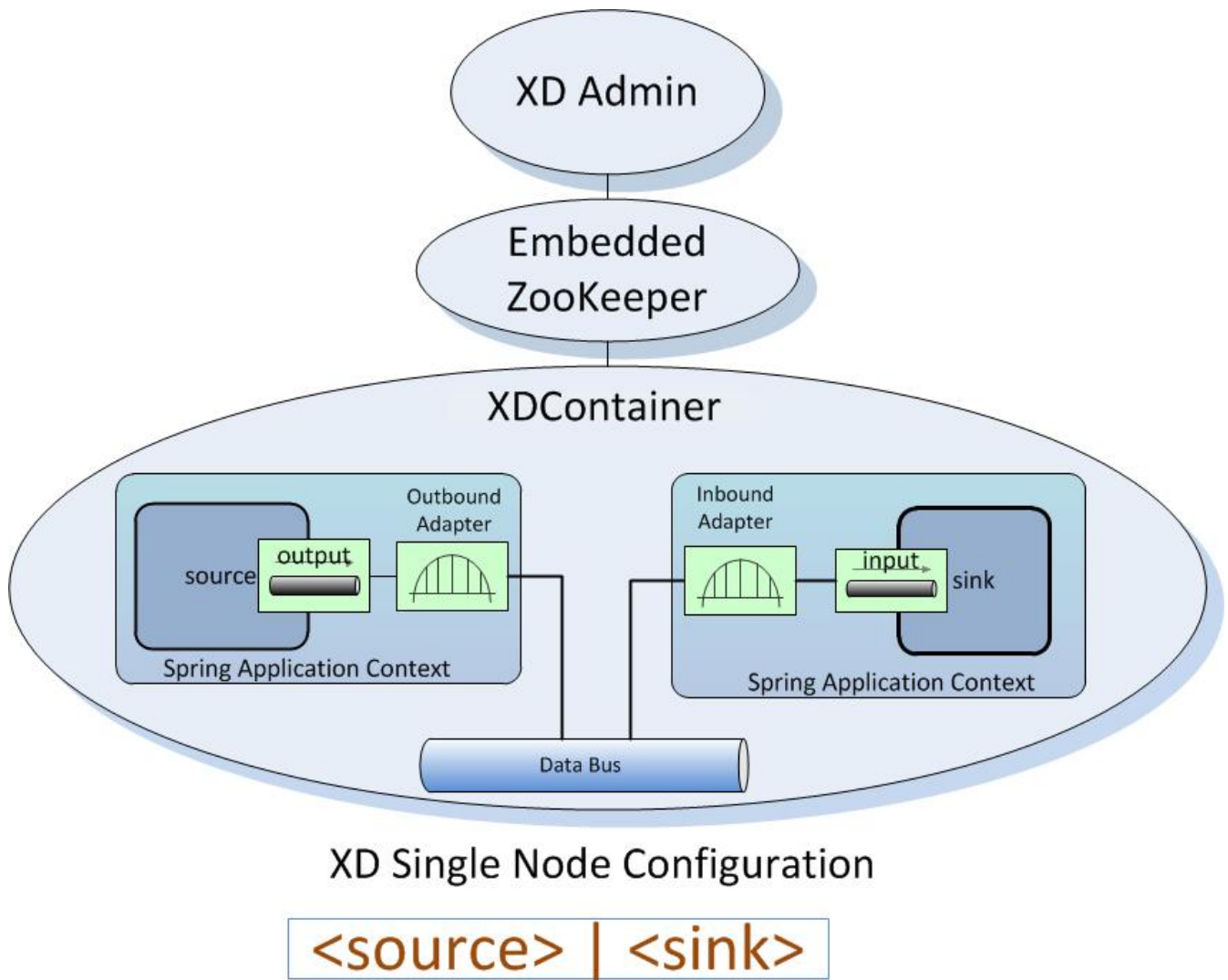

Figure 6.6. A Stream Deployed in a single node server

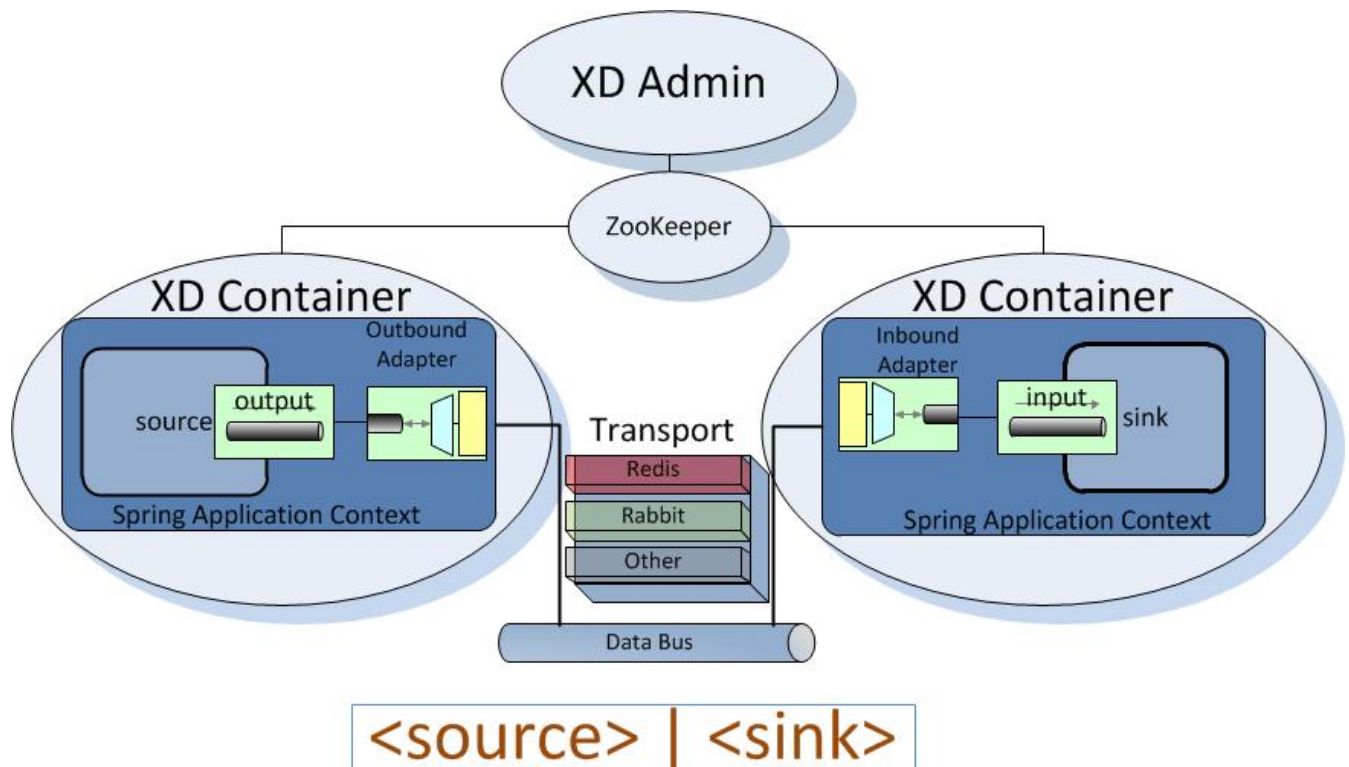

Figure 6.7. A Stream Deployed in a distributed runtime

In the `http | file` example, the Admin assigns each module to a separate Container instance, provided there are at least two Containers available. The `file` module is deployed to one container and the `http` module to another. The definition of a module is stored in a Module Registry. A module definition consists of a Spring XML configuration file, some classes used to validate and handle options defined by the module, and dependent jars. The module definition contains variable placeholders, corresponding to DSL parameters (called *options*) that allow you to customize the behavior of the module. For example, setting the `http` listening port would be done by passing in the option `--port`, e.g. `http --port=8090 | file`, which is in turn used to substitute a placeholder value in the module definition.

The Module Registry is backed by the filesystem and corresponds to the directory `<xd-install-directory>/modules`. When a module deployment is handled by the Container, the module definition is loaded from the registry and a new `Spring ApplicationContext` is created in the Container process to run the module. Dependent classes are loaded via the Module Classloader which first looks at jars in the `modules/lib` directory before delegating to the parent classloader.

Using the DIRT runtime, the `http | file` example would map onto the following runtime architecture

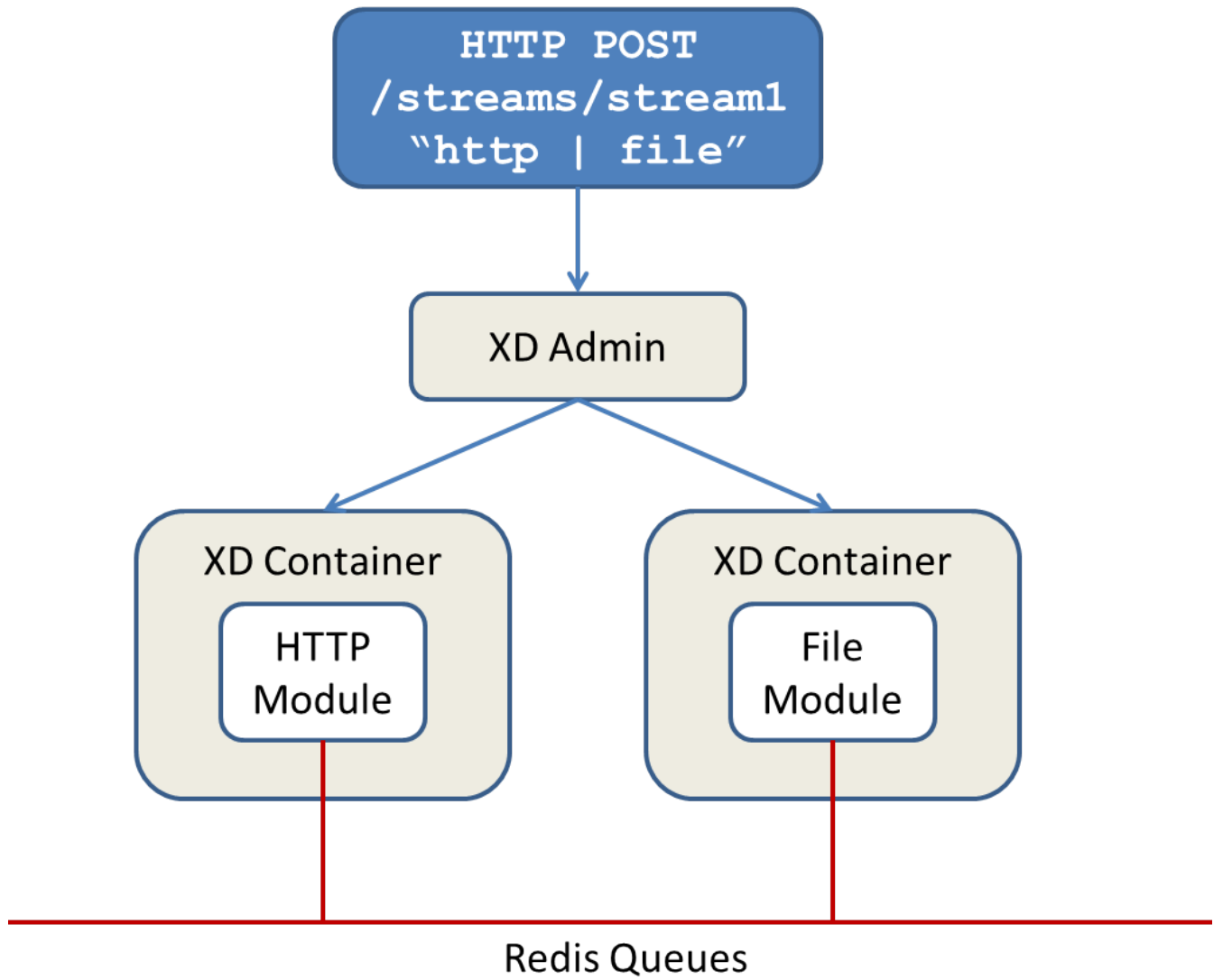

Figure 6.8. Distributed HTTP to File Stream

Data produced by the HTTP module is sent over a Redis Queue and is consumed by the File module. If there was a filter processing module in the stream definition, e.g `http | filter | file` that would map onto the following DIRT runtime architecture.

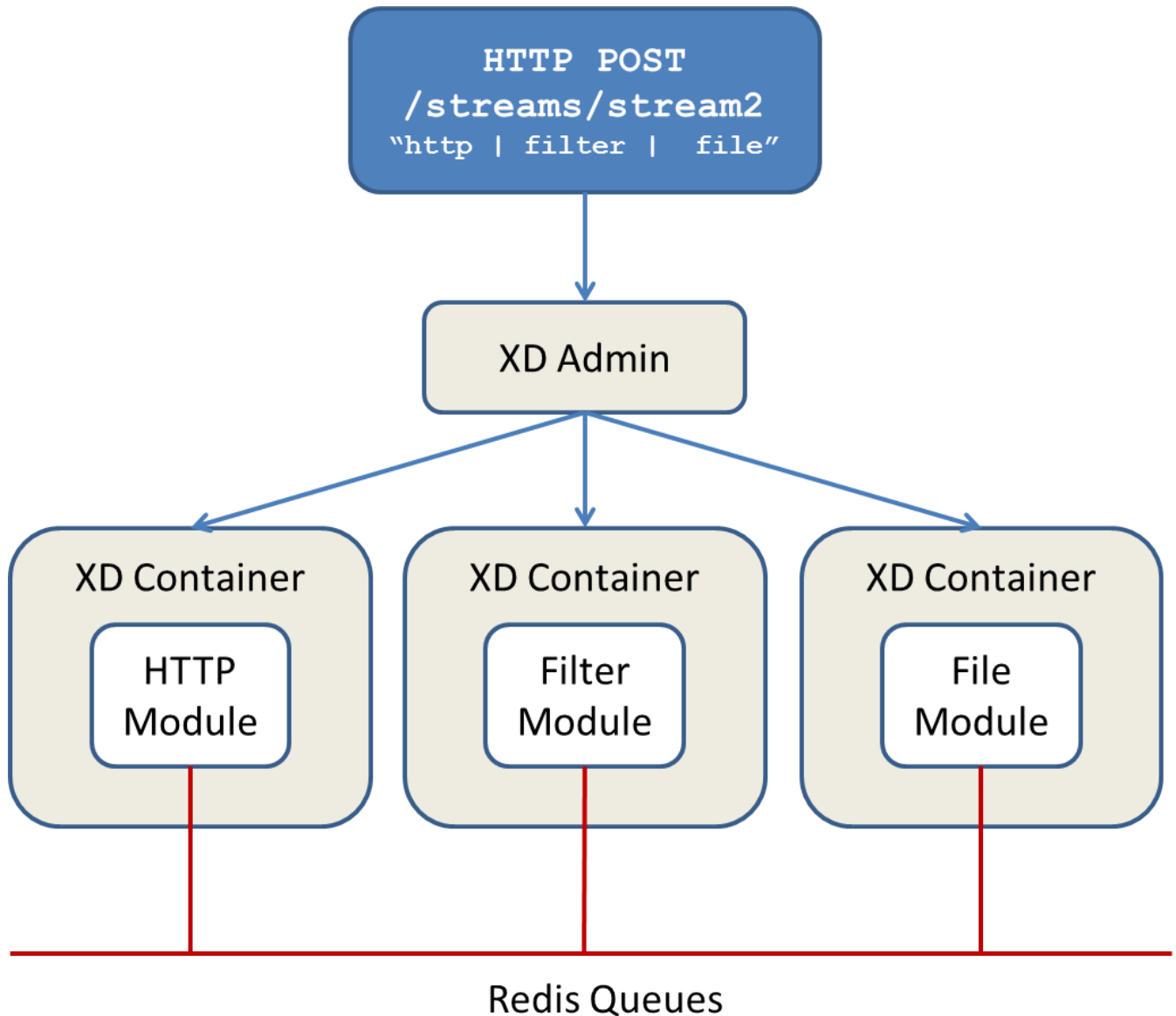

Figure 6.9. Distributed HTTP to Filter to File Stream

6.2 Jobs

The creation and execution of Batch jobs builds upon the functionality available in the Spring Batch and Spring for Apache Hadoop projects. See the [Batch Jobs](#) section for more information.

6.3 Taps

Taps provide a non-invasive way to consume the data that is being processed by either a Stream or a Job, much like a real time telephone wire tap lets you eavesdrop on telephone conversations. Taps are recommended as way to collect metrics and perform analytics on a Stream of data. See the section [Taps](#) for more information.

7. Distributed Runtime

7.1 Introduction

This document describes what's happening "under the hood" of the Spring XD Distributed Runtime (DIRT) and in particular, how the runtime architecture achieves high availability and failover in a clustered production environment. See [Running in Distributed Mode](#) for more information on installing and running Spring XD in distributed mode.

This discussion focuses on Spring XD's core runtime components and the role of [ZooKeeper](#) in managing the state of the Spring XD cluster and enabling automatic recovery from failures.

7.2 Configuring Spring XD for High Availability(HA)

A production Spring XD environment is typically distributed among multiple hosts in a clustered environment. Spring XD scales horizontally when you add container instances. In the simplest case, all containers are replicas, that is each instance is running on an identically configured host and modules are deployed to any available container in a round-robin fashion. However, this simplifying assumption does not address real production scenarios in which more control is required in order to optimize resource utilization. To this end, Spring XD supports a flexible algorithm which allows you to match module deployments to specific container configurations. The container matching algorithm will be covered in more detail later, but for now, let's assume the simple case. Running multiple containers not only enables horizontal scalability, but enables failure recovery. If a container becomes unavailable due to an unrecoverable connection loss, any modules currently deployed to that container will be deployed automatically to the other available instances.

Spring XD requires that a single active Admin server handle interactions with the containers, such as stream deployment requests, as these types of operations must be processed serially in the order received. Without a backup, the Admin server becomes single point of failure. Therefore, two (or more for the risk averse) Admin servers are recommended for a production environment. Note that every Admin server can handle all requests via [REST](#) endpoints but only one instance, the "Leader", will actually perform requests that update the runtime state. If the Leader goes down, another available Admin server will assume the leader role. [Leader Election](#) is an example of a common feature for distributed systems provided by the [Curator Framework](#) which sits on top of ZooKeeper.

An HA Spring XD installation also requires that external servers - ZooKeeper, messaging middleware, and data stores needed for [running Spring XD in distributed mode](#) must be configured for HA as well. Please consult the product documentation for specific recommendations regarding each of these external components. Also see [Message Bus Configuration](#) for tips on configuring the MessageBus for HA, error handling, etc.

7.3 ZooKeeper Overview

In the previous section, we claimed that if a container goes down, Spring XD will redeploy any modules deployed on that instance to another available container. We also claimed that if the Admin Leader goes down, another Admin server will assume that role. [ZooKeeper](#) is what makes this all possible. ZooKeeper is a widely used Apache project designed primarily for distributed system management and coordination. This section will cover some basic concepts necessary to understand its role in Spring XD. See [The ZooKeeper Wiki](#) for a more complete overview.

ZooKeeper is based on a simple hierarchical data structure, formally a tree, and conceptually and semantically similar to a file directory structure. As such, data is stored in *nodes*. A node is referenced via a *path*, for example, `/xd/streams/mystream`. Each node can store additional data, serialized as a byte array. In Spring XD, all data is a `java.util.Map` serialized as JSON. The following figure shows the Spring XD schema:

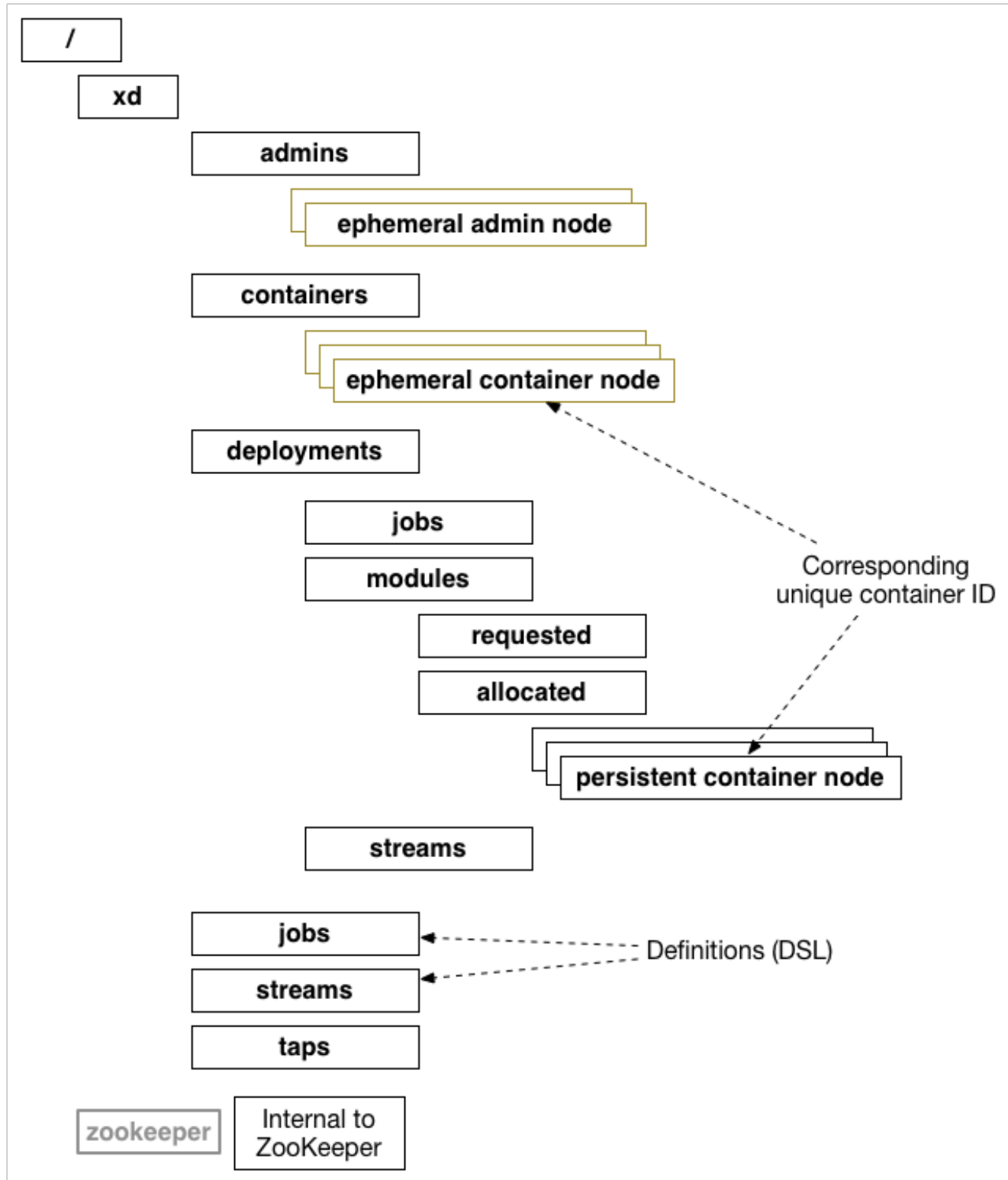

A ZooKeeper node is either *ephemeral* or *persistent*. An ephemeral node exists only as long as the session that created it remains active. A persistent node is, well, persistent. Ephemeral nodes are

appropriate for registering Container instances. When a Spring XD container starts up it creates an ephemeral node, `/xd/containers/<container-id>`, using an internally generated container id. When the container's session is closed due to a connection loss, for example, the container process terminates, its node is removed. The ephemeral container node also holds metadata such as its hostname and IP address, runtime metrics, and user defined container attributes. Persistent nodes maintain state needed for normal operation and recovery. This includes data such as stream definitions, job definitions, deployment manifests, module deployments, and deployment state for streams and jobs.

Obviously ZooKeeper is a critical piece of the Spring XD runtime and must itself be HA. ZooKeeper itself supports a distributed architecture, called an *ensemble*. The details are beyond the scope of this document but for the sake of this discussion it is worth mentioning that there should be at least three ZooKeeper server instances running (an odd number is always recommended) on dedicated hosts. The Container and Admin nodes are clients to the ZooKeeper ensemble and must connect to ZooKeeper at startup. Spring XD components are configured with a `zk.client.connect` property which may designate a single `<host>:<port>` or a comma separated list. The ZooKeeper client will attempt to connect to each server in order until it succeeds. If it is unable to connect, it will keep trying. If a connection is lost, the ZooKeeper client will attempt to reconnect to one of the servers. The ZooKeeper cluster guarantees consistent replication of data across the ensemble. Specifically, ZooKeeper guarantees:

- Sequential Consistency - Updates from a client will be applied in the order that they were sent.
- Atomicity - Updates either succeed or fail. No partial results.
- Single System Image - A client will see the same view of the service regardless of the server that it connects to.
- Reliability - Once an update has been applied, it will persist from that time forward until a client overwrites the update.
- Timeliness - The clients view of the system is guaranteed to be up-to-date within a certain time bound.

ZooKeeper maintains data primarily in memory backed by a disk cache. Updates are logged to disk for recoverability, and writes are serialized to disk before they are applied to the in-memory database.

In addition to performing basic CRUD operations on nodes, A ZooKeeper client can register a callback on a node to respond to any events or state changes to that node or any of its children. Such node operations and callbacks are the mechanism that control the Spring XD runtime.

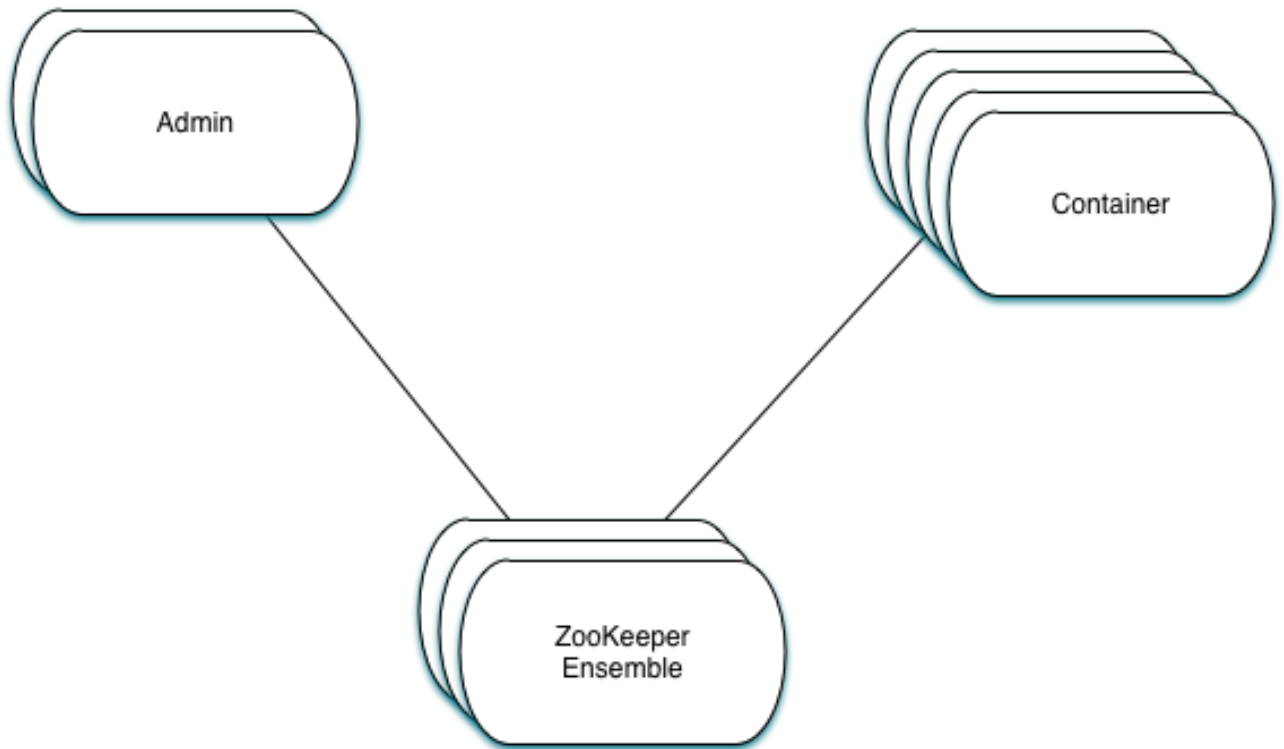

7.4 The Admin Server Internals

Assuming more than one Admin instance is running, Each instance requests leadership at start up. If there is already a designated leader, the instance will watch the `xd/admin` node to be notified if the Leader goes away. The instance designated as the "Leader", using the Leader Selector recipe provided by [Curator](#), a ZooKeeper client library that implements some common patterns. Curator also provides some Listener callback interfaces that the client can register on a node. The AdminServer creates the top level nodes, depicted in the figure above:

- **`/xd/admins`** - children are ephemeral nodes for each available Admin instance and used for Leader Selector
- **`/xd/containers`** - children are ephemeral nodes containing runtime attributes including hostname, process id, ip address, and user defined attributes for each container instance.
- **`/xd/streams`** - children are persistent nodes containing the definition (DSL) for each stream.
- **`/xd/jobs`** - children are persistent nodes containing the definition (DSL) for each job.
- **`/xd/taps`** - children are persistent nodes describing each deployed tap.
- **`/xd/deployments/streams`** - children are nodes containing stream deployment status (leaf nodes are ephemeral).
- **`/xd/deployments/jobs`** - children are nodes containing job deployment status (leaf nodes are ephemeral).
- **`/xd/deployments/modules/requested`** - stores module deployment requests including deployment criteria.

- **/xd/deployments/modules/allocated** - stores information describing currently deployed modules.

The admin leader creates a DeploymentSupervisor which registers listeners on `/xd/deployments/modules/requested` to handle module deployment requests related to stream and job deployments, and `/xd/containers/` to be notified when containers are added and removed from the cluster. Note that any Admin instance can handle user requests. For example, if you enter the following commands via XD shell,

```
xd>stream create ticktock --definition "time | log"
```

This command will invoke a REST service on its connected Admin instance to create a new node `/xd/streams/ticktock`

```
xd>stream deploy ticktock
```

Assuming the deployment is successful, This will result in the creation of several nodes used to manage deployed resources, for example, `/xd/deployments/streams/ticktock`. The details are discussed in the [example below](#).

If the Admin instance connected to the shell is not the Leader, it will perform no further action. The Leader's DeploymentSupervisor will attempt to deploy each module in the stream definition, in accordance with the deployment manifest, to an available container, and update the runtime state.

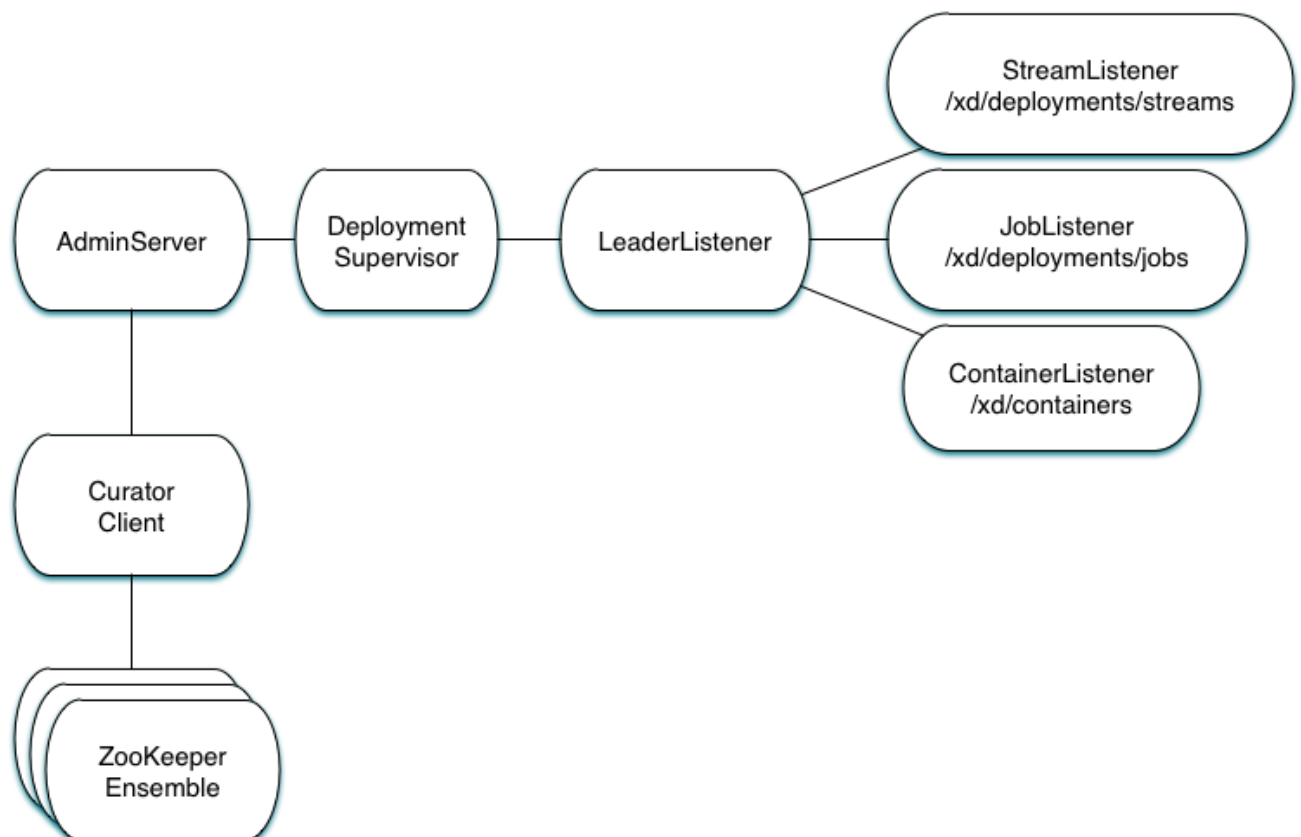

Example

Let's walk through the simple example above. If you don't have a Spring XD cluster set up, this example can be easily executed running Spring XD in a single node configuration. The single node

application includes an embedded ZooKeeper server by default and allocates a random unused port. The embedded ZooKeeper connect string is reported in the console log for the single node application:

```
...
13:04:27,016 INFO main util.XdConfigLoggingInitializer - Transport: local
13:04:27,016 INFO main util.XdConfigLoggingInitializer - Hadoop Distro: hadoop22
13:04:27,019 INFO main util.XdConfigLoggingInitializer - Hadoop version detected from classpath: 2.2.0
13:04:27,019 INFO main util.XdConfigLoggingInitializer - Zookeeper at: localhost:31316
...
```

For our purposes, we will use the ZooKeeper CLI tool to inspect the contents of ZooKeeper nodes reflecting the current state of Spring XD. First, we need to know the port to connect the CLI tool to the embedded server. For convenience, we will assign the ZooKeeper port (5555 in this example) when starting the single node application. From the XD install directory:

```
$export JAVA_OPTS="-Dzk.embedded.server.port=5555"
$xd/bin/xd-singlenode
```

In another terminal session, start the ZooKeeper CLI included with ZooKeeper to connect to the embedded server and inspect the contents of the nodes (NOTE: tab completion works) :

```
$zkCli.sh -server localhost:5555
```

After some console output, you should see a prompt:

```
WatchedEvent state:SyncConnected type:None path:null
[zk: localhost:5555(CONNECTED) 0]
```

navigate using the `ls` command. This will reflect the schema shown in the figure above, the unique container ID will be different for you.

```
[[zk: localhost:5555(CONNECTED) 0] ls /xd
[deployments, containers, admins, taps, streams, jobs]
[zk: localhost:5555(CONNECTED) 1] ls /xd/streams
[]
[zk: localhost:5555(CONNECTED) 2] ls /xd/deployments
[jobs, streams, modules]
[zk: localhost:5555(CONNECTED) 3] ls /xd/deployments/streams
[]
[zk: localhost:5555(CONNECTED) 4] ls /xd/deployments/modules
[requested, allocated]
[zk: localhost:5555(CONNECTED) 5] ls /xd/deployments/modules/allocated
[2ebbbc9b-63ac-4da4-aa32-e39d69eb546b]
[zk: localhost:5555(CONNECTED) 6] ls /xd/deployments/modules/2ebbbc9b-63ac-4da4-aa32-e39d69eb546b
[]
[zk: localhost:5555(CONNECTED) 7] ls /xd/containers
[2ebbbc9b-63ac-4da4-aa32-e39d69eb546b]
[zk: localhost:5555(CONNECTED) 8]
```

The above reflects the initial state of Spring XD with a running admin and container instance. Nothing is deployed yet and there are no existing stream or job definitions. Note that `xd/deployments/modules/allocated` has a persistent child corresponding to the id of the container at `xd/containers`. If you are running in a distributed configuration and connected to one of the ZooKeeper servers in the same ensemble that Spring XD is connected to, you might see multiple nodes under `/xd/containers`, and `xd/admins`. Because the external ensemble persists the state of the Spring XD cluster, you will also see any deployments that existed when the Spring XD cluster was shut down.

Start the XD Shell in a new terminal session and create a stream:

Spring XD decomposes stream deployment requests to individual module deployment requests. Hence, we see that each module in the stream is associated with a container instance. The container instance in this case is the same since there is only one instance in the single node configuration. In a distributed configuration with more than one instance, the stream source and sink will each be deployed to a separate container. The node name itself is of the form `<module_type>.<module_name>.<module_sequence_number>.<container_id>`, where the sequence number identifies a deployed instance of a module if multiple instances of that module are requested.

```
[zk: localhost:2181(CONNECTED) 14] ls /xd/deployments/modules/allocated/2ebbbc9b-63ac-4da4-aa32-
e39d69eb546b/ticktock.source.time.1
[metadata, status]
```

The *metadata* and *status* nodes are ephemeral nodes which store details about the deployed module. This information is provided to XD shell queries. For example:

```
xd:>runtime modules
Module                Container Id          Options
Deployment Properties
-----
ticktock.sink.log.1   2ebbbc9b-63ac-4da4-aa32-e39d69eb546b {name=ticktock, expression=payload,
level=INFO} {count=1, sequence=1}
ticktock.source.time.1 2ebbbc9b-63ac-4da4-aa32-e39d69eb546b {fixedDelay=1, format=yyyy-MM-dd
HH:mm:ss} {count=1, sequence=1}
```

7.5 Module Deployment

This section describes how the Spring XD runtime manages deployment internally. For more details on how to deploy streams and jobs see Chapter 29, *Deployment*.

To process a stream deployment request, the *StreamDeploymentListener* invokes its *ContainerMatcher* to select a container instance for each module and records the module's deployment properties under `/xd/deployments/modules/requested/`. If a match is found, the *StreamDeploymentListener* creates a node for the module under `/xd/deployments/modules/allocated/<container_id>`. The Container includes a *DeploymentListener* that monitors the container node for new modules to deploy. If the deployment is successful, the Container writes the ephemeral nodes *status* and *metadata* under the new module node.

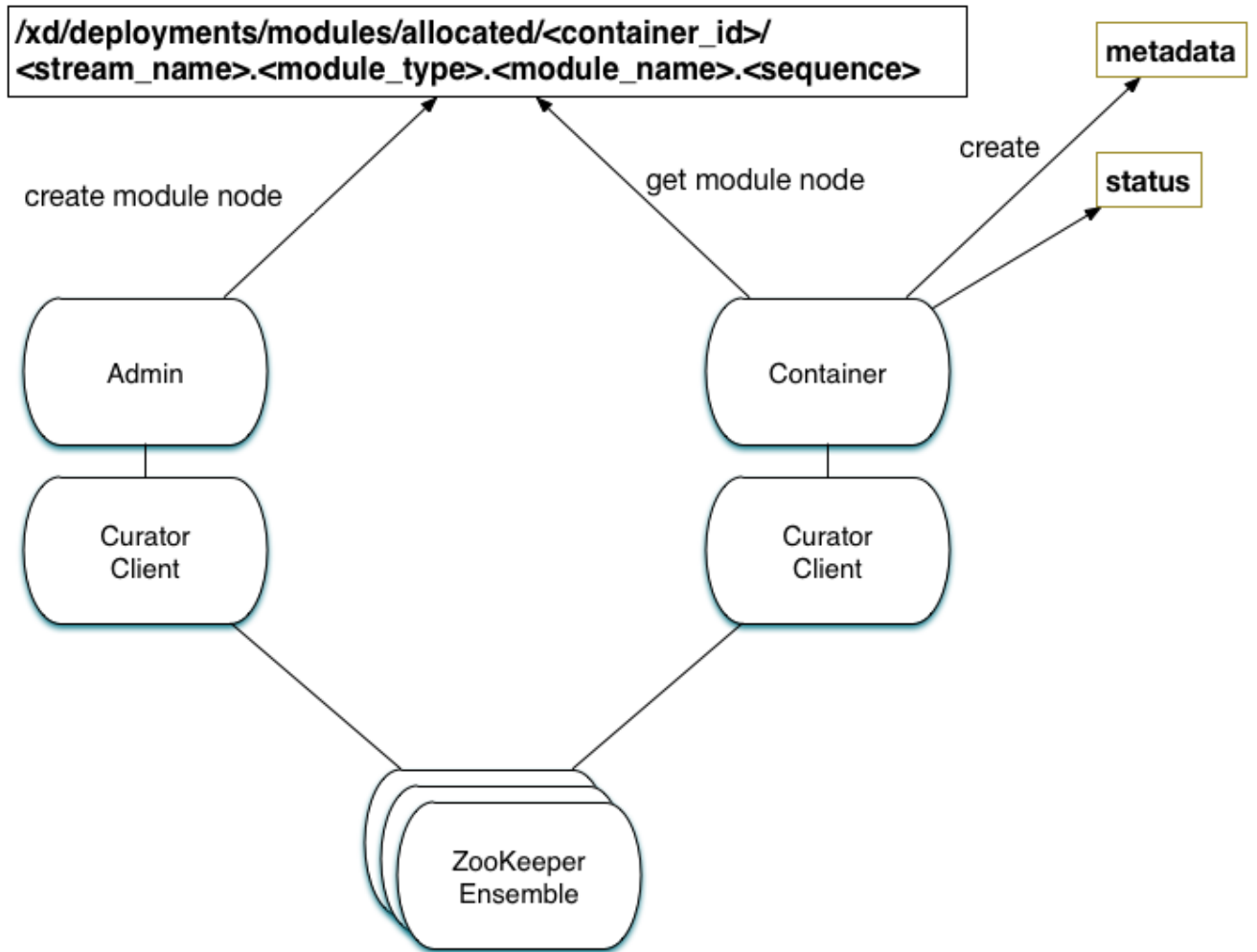

When a container departs, the ephemeral nodes are deleted so its modules are now undeployed. The *ContainerListener* responds to the deleted nodes and attempts to redeploy any affected modules to another instance.

Example: Automatic Redeployment

For this example we start two container instances and deploy and simple stream:

```

xd:>runtime containers
Container Id          Host          IP Address  PID    Groups  Custom Attributes
-----
0ddf80b9-1e80-44b8-8c12-ecc5c8c32e11  ultrafox.local  192.168.1.6  19222
6cac85f8-4c52-4861-a225-cdad3675f6c9  ultrafox.local  192.168.1.6  19244

xd:>stream create ticktock --definition "time | log"
Created new stream 'ticktock'
xd:>stream deploy ticktock
Deployed stream 'ticktock'
xd:>runtime modules
Module              Container Id          Options
Deployment Properties
-----
ticktock.sink.log.1  0ddf80b9-1e80-44b8-8c12-ecc5c8c32e11  {name=ticktock, expression=payload,
level=INFO} {count=1, sequence=1}
ticktock.source.time.1  6cac85f8-4c52-4861-a225-cdad3675f6c9  {fixedDelay=1, format=yyyy-MM-dd
HH:mm:ss} {count=1, sequence=1}
  
```

Now we will kill one of the container processes and observe that the affect module has been redeployed to the remaining container:

```
xd:>runtime containers
Container Id          Host          IP Address  PID    Groups  Custom Attributes
-----
6cac85f8-4c52-4861-a225-cdad3675f6c9  ultrafox.local  192.168.1.6  19244

xd:>runtime modules
Module                Container Id          Options
Deployment Properties
-----
ticktock.sink.log.1   6cac85f8-4c52-4861-a225-cdad3675f6c9  {name=ticktock, expression=payload,
level=INFO} {count=1, sequence=1}
ticktock.source.time.1 6cac85f8-4c52-4861-a225-cdad3675f6c9  {fixedDelay=1, format=yyyy-MM-dd
HH:mm:ss}   {count=1, sequence=1}
```

Now if we kill the remaining container, we see warnings in the xd-admin log:

```
14:36:07,593 WARN DeploymentSupervisorCacheListener-0 server.DepartingContainerModuleRedeployer - No
containers available for redeployment of log for stream ticktock
14:36:07,599 WARN DeploymentSupervisorCacheListener-0 server.DepartingContainerModuleRedeployer - No
containers available for redeployment of time for stream ticktock
```

8. Batch Jobs

8.1 Introduction

One of the features that XD offers is the ability to launch and monitor batch jobs based on [Spring Batch](#). The Spring Batch project was started in 2007 as a collaboration between SpringSource and Accenture to provide a comprehensive framework to support the development of robust batch applications. Batch jobs have their own set of best practices and domain concepts which have been incorporated into Spring Batch building upon Accenture's consulting business. Since then Spring Batch has been used in thousands of enterprise applications and is the basis for the recent JSR standardization of batch processing, [JSR-352](#).

Spring XD builds upon Spring Batch to simplify creating batch workflow solutions that span traditional use-cases such as moving data between flat files and relational databases as well as Hadoop use-cases where analysis logic is broken up into several steps that run on a Hadoop cluster. Steps specific to Hadoop in a workflow can be MapReduce jobs, executing Hive/Pig scripts or HDFS operations.

8.2 Workflow

The concept of a workflow translates to a Job, not to be confused with a MapReduce job. A Job is a directed graph, each node of the graph is a processing Step. Steps can be executed sequentially or in parallel, depending on the configuration. Jobs can be started, stopped, and restarted. Restarting jobs is possible since the progress of executed steps in a Job is persisted in a database via a JobRepository. The following figures shows the basic components of a workflow.

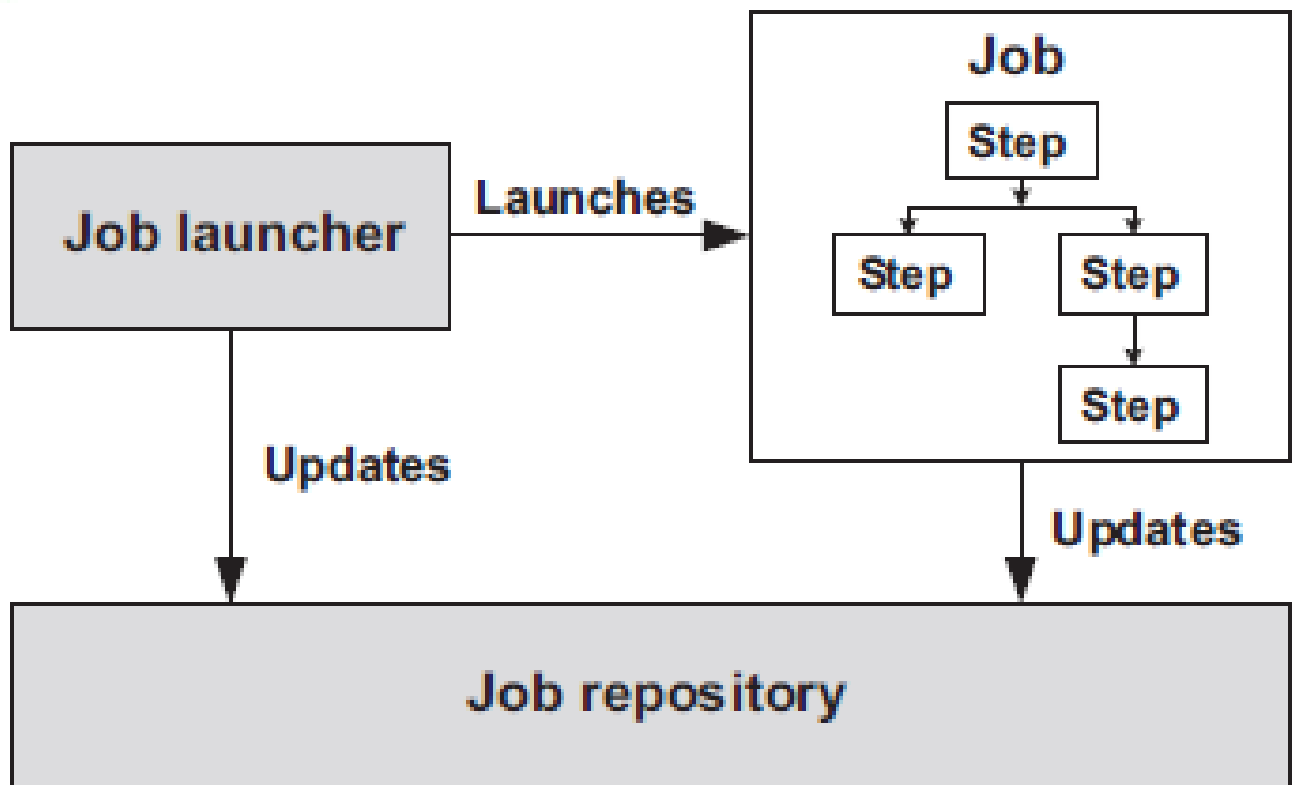

A Job that has steps specific to Hadoop is shown below.

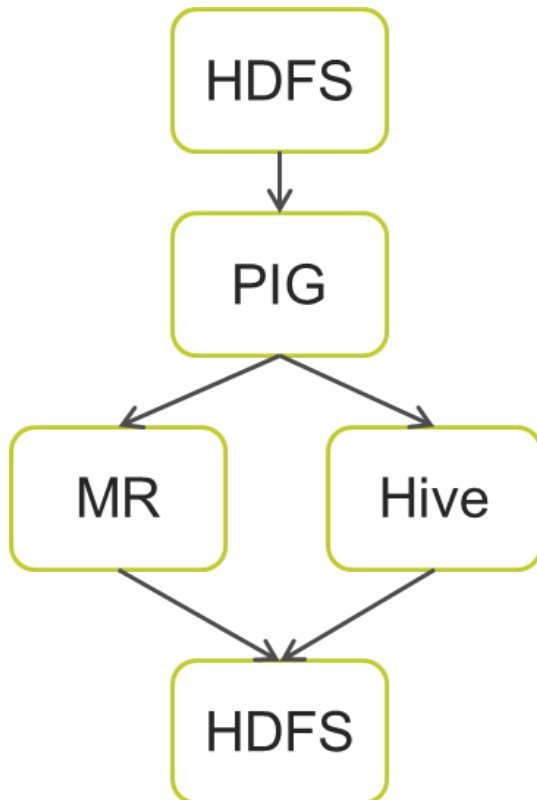

A JobLauncher is responsible for starting a job and is often triggered via a scheduler. Other options to launch a job are through Spring XD's RESTful administration API, the XD web application, or in response to an external event from an XD stream definition, *e.g.* file polling using the file source.

8.3 Features

Spring XD allows you to create and launch jobs. The launching of a job can be triggered using a cron expression or in reaction to data on a stream. When jobs are executing, they are also a source of event data that can be subscribed to by a stream. There are several types of events sent during a job's execution, the most common being the status of the job and the steps taken within the job. This bi-direction communication between stream processing and batch processing allows for more complex chains of processing to be developed.

As a starting point, jobs for the following cases are provided to use out of the box

- Poll a Directory and import CSV files to HDFS
- Import CSV files to JDBC
- HDFS to JDBC Export
- JDBC to HDFS Import
- HDFS to MongoDB Export

These are described in the section below.

The purpose of this section is to show you how to create, schedule and monitor a job.

8.4 The Lifecycle of a Job in Spring XD

Before we dive deeper into the details of creating batch jobs with Spring XD, we need to understand the typical lifecycle for batch jobs in the context of *Spring XD*:

1. Register a Job Module
2. Create a Job Definition
3. Deploy a Job
4. Launch a Job
5. Job Execution
6. Un-deploy a Job
7. Destroy a Job Definition

Register a Job Module

Register a **Job Module** with the *Module Registry* by putting XML and/or jar files into the `$XD_HOME/modules/jobs` directory.

Create a Job Definition

Create a **Job Definition** from a *Job Module* by providing a definition name as well as properties that apply to all *Job Instances*. At this point the job is not deployed, yet.

Deploy the Job

Deploy the **Job Definition** to one or more *Spring XD* containers. This will initialize the *Job Definitions* on those containers. The jobs are now "live" and a job can be created by sending a message to a job queue that contains optional runtime [Job Parameters](#).

Launch a Job

Launch a job by sending a message to the job queue with [Job Parameters](#). A [Job Instance](#) is created, representing a specific run of the job. A **Job Instance** is the **Job Definition** plus the runtime **Job Parameters**. You can query for the **Job Instances** associated with a given job name.

Job Execution

The job is executed creating a [Job Execution](#) object that captures the success or failure of the job. You can query for **Job Executions** associated with a given job name.

Un-deploy a Job

This removes the job from the *Spring XD* container(s) preventing the launching of any new *Job Instances*. For reporting purposes, you will still be able to view historic *Job Executions* associated with the the job.

Destroy a Job Definition

Destroying a **Job Definition** will not only un-deploy any still deployed *Job Definitions* but will also remove the *Job Definition* itself.

Creating Jobs - Additional Options

When creating jobs, the following options are available to all job definitions:

`dateFormat`

The optional date format for job parameters (**default: `YYYY-MM-dd`**)

`numberFormat`

Defines the number format when parsing numeric parameters (**default: `NumberFormat.getInstance(Locale.US)`**)

`makeUnique`

Shall job parameters be made unique? (**default: `true`**)

Also, similar to the `stream create` command, the `job create` command has an optional `--deploy` option to create the job definition and deploy it. `--deploy` option is false by default.

Below is an example of some of these options combined:

```
job create myjob --definition "fooJob --makeUnique=false"
```

Remember that you can always find out about available options for a job by using the [module info](#) command.

8.5 Deployment manifest support for job

When deploying batch job you can provide a [deployment manifest](#). Deployment manifest properties for jobs are the same as for streams, you can declare

- The number of job modules to deploy
- The criteria expression to use for matching the job to available containers

For example,

```
job create myjob --definition "fooJob --makeUnique=false"

job deploy myjob --properties "module.fooJob.count=3,module.fooJob.criteria=groups.contains('hdfs-
containers-group')"
```

The above deployment manifest would deploy 3 number of `fooJob` modules into containers whose group name matches "hdfs-containers-group".

When a batch job is launched/scheduled, the job module that picks up the job launching request message executes the batch job. To support partitioning of the job across multiple containers, the job definition needs to define how the job will be partitioned. The type of partitioning depends on the type of the job, for example a job reading from JDBC would partition the data in a table by dividing up the number of rows and a job reading files from a directory would partition on the number of files available.

The FTP to HDFS and FILE to JDBC jobs support for partitioning. To add partitioning support for your own jobs you should import [singlestep-partition-support.xml](#) in your job definition. This provides the infrastructure so that the job module that processes the launch request can communicate as the master with the other job modules that have been deployed. You will also need to provide an implementation of the [Partitioner](#) interface.

For more information on the deployment manifest, please refer [here](#)

8.6 Launching a job

XD uses triggers as well as regular event flow to launch the batch jobs. So in this section we will cover how to:

- Launch the Batch Job Ad-hoc
- Launch the Batch Job using a named Cron-Trigger
- Launch the Batch Job as sink.

Ad-hoc

To launch a job one time, use the launch option of the job command. So going back to our example above, we've created a job module instance named helloSpringXD. Launching that Job Module Instance would look like:

```
xd:> job launch helloSpringXD
```

In the logging output of the XDContainer you should see the following

```
16:45:40,127 INFO http-bio-9393-exec-1 job.JobPlugin:98 - Configuring module with the following
properties: {numberFormat=, dateFormat=, makeUnique=true, xd.job.name=myjob}
16:45:40,185 INFO http-bio-9393-exec-1 module.SimpleModule:140 - initialized module: SimpleModule
[name=job, type=job, group=myjob, index=0 @3a9ecb9d]
16:45:40,198 INFO http-bio-9393-exec-1 module.SimpleModule:161 - started module: SimpleModule
[name=job, type=job, group=myjob, index=0 @3a9ecb9d]
16:45:40,199 INFO http-bio-9393-exec-1 module.ModuleDeployer:161 - deployed SimpleModule [name=job,
type=job, group=myjob, index=0 @3a9ecb9d]
Hello Spring XD!
```

To re-launch the job just execute the launch command. For example:

```
xd:> job launch helloSpringXD
```

Launch the Batch using Cron-Trigger

To launch a batch job based on a cron scheduler is done by creating a stream using the trigger source.

```
xd:> stream create --name cronStream --definition "trigger --cron='0/5 * * * * *' >
queue:job:myCronJob" --deploy
```

A batch job can receive parameters from a source (in this case a trigger) or process. A trigger uses the --payload expression to declare its payload.

```
xd:> stream create --name cronStream --definition "trigger --cron='0/5 * * * * *' --
payload={\"param1\": \"Kenny\"} > queue:job:myCronJob" --deploy
```

Note

The payload content must be in a JSON-based map representation.

To pause/stop future scheduled jobs from running for this stream, the stream must be undeployed for example:

```
xd:> stream undeploy --name cronStream
```

Launch the Batch using a Fixed-Delay-Trigger

A fixed-delay-trigger is used to launch a Job on a regular interval. Using the `--fixedDelay` parameter you can set up the number of seconds between executions. In the example below we are running `myXDJob` every 10 seconds and passing it a payload containing a single attribute.

```
xd:> stream create --name fdStream --definition "trigger --payload={\"param1\": \"fixedDelayKenny\"} --fixedDelay=5 > queue:job:myXDJob" --deploy
```

To pause/stop future scheduled jobs from running for this stream, you must undeploy the stream for example:

```
xd:> stream undeploy --name fdStream
```

Launch job as a part of event flow

A batch job is always used as a sink, with that being said it can receive messages from sources (other than triggers) and processors. In the case below we see that the user has created an http source (http source receives http posts and passes the payload of the http message to the next module in the stream) that will pass the http payload to the "myHttpJob".

```
stream create --name jobStream --definition "http > queue:job:myHttpJob" --deploy
```

To test the stream you can execute a http post, like the following:

```
xd:> http post --target http://localhost:9000 --data "{\"param1\": \"fixedDelayKenny\"}"
```

8.7 Retrieve job notifications

Spring XD offers the facilities to capture the notifications that are sent from the job as it is executing. When a batch job is deployed, by default it registers the following listeners along with pub/sub channels that these listeners send messages to.

- Job Execution Listener
- Chunk Listener
- Item Listener
- Step Execution Listener
- Skip Listener

Along with the pub/sub channels for each of these listeners, there will also be a pub/sub channel that the aggregated events from all these listeners are published to.

In the following example, we setup a Batch Job called *myHttpJob*. Afterwards we create a stream that will tap into the pub/sub channels that were implicitly generated when the *myHttpJob* job was deployed.

To receive aggregated events

The stream receives aggregated event messages from all the default batch job listeners and sends those messages to the log.

```
xd>job create --name myHttpJob --definition "httpJob" --deploy
xd>stream create --name aggregatedEvents --definition "tap:job:myHttpJob >log" --deploy
xd>job launch myHttpJob
```

Note: The syntax for the tap that receives the aggregated events is: `tap:job:<job-name>`

In the logging output of the container you should see something like the following when the job completes (with the aggregated events)

```
09:55:53,532 WARN SimpleAsyncTaskExecutor-1 logger.aggregatedEvents:150 - JobExecution: id=2,
version=1, startTime=Sat Apr 12 09:55:53 PDT 2014, endTime=null, lastUpdated=Sat Apr 12 09:55:53 PDT
2014, status=STARTED, exitStatus=exitCode=UNKNOWN;exitDescription=, job=[JobInstance: id=2, version=0,
Job=[myHttpJob]], jobParameters=[{random=0.07002785662707867}]
09:55:53,554 WARN SimpleAsyncTaskExecutor-1 logger.aggregatedEvents:150 - StepExecution: id=2,
version=1, name=step1, status=STARTED, exitStatus=EXECUTING, readCount=0, filterCount=0, writeCount=0
readSkipCount=0, writeSkipCount=0, processSkipCount=0, commitCount=0, rollbackCount=0, exitDescription=
09:55:53,561 WARN SimpleAsyncTaskExecutor-1 logger.aggregatedEvents:150 - XdChunkContextInfo
[complete=false, stepExecution=StepExecution: id=2, version=1, name=step1, status=STARTED,
exitStatus=EXECUTING, readCount=0, filterCount=0, writeCount=0 readSkipCount=0, writeSkipCount=0,
processSkipCount=0, commitCount=0, rollbackCount=0, exitDescription=, attributes={}]
09:55:53,567 WARN SimpleAsyncTaskExecutor-1 logger.aggregatedEvents:150 - XdChunkContextInfo
[complete=false, stepExecution=StepExecution: id=2, version=2, name=step1, status=STARTED,
exitStatus=EXECUTING, readCount=0, filterCount=0, writeCount=0 readSkipCount=0, writeSkipCount=0,
processSkipCount=0, commitCount=1, rollbackCount=0, exitDescription=, attributes={}]
09:55:53,573 WARN SimpleAsyncTaskExecutor-1 logger.aggregatedEvents:150 - StepExecution: id=2,
version=2, name=step1, status=COMPLETED, exitStatus=COMPLETED, readCount=0, filterCount=0, writeCount=0
readSkipCount=0, writeSkipCount=0, processSkipCount=0, commitCount=1, rollbackCount=0, exitDescription=
09:55:53,580 WARN SimpleAsyncTaskExecutor-1 logger.aggregatedEvents:150 - JobExecution:
id=2, version=1, startTime=Sat Apr 12 09:55:53 PDT 2014, endTime=Sat Apr 12
09:55:53 PDT 2014, lastUpdated=Sat Apr 12 09:55:53 PDT 2014, status=COMPLETED,
exitStatus=exitCode=COMPLETED;exitDescription=, job=[JobInstance: id=2, version=0, Job=[myHttpJob]],
jobParameters=[{random=0.07002785662707867}]
```

To receive job execution events

```
xd>job create --name myHttpJob --definition "httpJob" --deploy
xd>stream create --name jobExecutionEvents --definition "tap:job:myHttpJob.job >log" --deploy
xd>job launch myHttpJob
```

Note: The syntax for the tap that receives the job execution events is: `tap:job:<job-name>.job`

In the logging output of the container you should see something like the following when the job completes

```
10:06:41,579 WARN SimpleAsyncTaskExecutor-1 logger.jobExecutionEvents:150 - JobExecution: id=3,
version=1, startTime=Sat Apr 12 10:06:41 PDT 2014, endTime=null, lastUpdated=Sat Apr 12 10:06:41 PDT
2014, status=STARTED, exitStatus=exitCode=UNKNOWN;exitDescription=, job=[JobInstance: id=3, version=0,
Job=[myHttpJob]], jobParameters=[{random=0.3774227747555795}]
10:06:41,626 INFO SimpleAsyncTaskExecutor-1 support.SimpleJobLauncher:136 - Job: [FlowJob:
[name=myHttpJob]] completed with the following parameters: [{random=0.3774227747555795}] and the
following status: [COMPLETED]
10:06:41,626 WARN SimpleAsyncTaskExecutor-1 logger.jobExecutionEvents:150 -
JobExecution: id=3, version=1, startTime=Sat Apr 12 10:06:41 PDT 2014, endTime=Sat
Apr 12 10:06:41 PDT 2014, lastUpdated=Sat Apr 12 10:06:41 PDT 2014, status=COMPLETED,
exitStatus=exitCode=COMPLETED;exitDescription=, job=[JobInstance: id=3, version=0, Job=[myHttpJob]],
jobParameters=[{random=0.3774227747555795}]
```

To receive step execution events

```
xd>job create --name myHttpJob --definition "httpJob" --deploy
xd>stream create --name stepExecutionEvents --definition "tap:job:myHttpJob.step >log" --deploy
xd>job launch myHttpJob
```

Note: The syntax for the tap that receives the step execution events is: `tap:job:<job-name>.step`

In the logging output of the container you should see something like the following when the job completes

```
10:13:16,072 WARN SimpleAsyncTaskExecutor-1 logger.stepExecutionEvents:150 - StepExecution: id=6,
version=1, name=step1, status=STARTED, exitStatus=EXECUTING, readCount=0, filterCount=0, writeCount=0
readSkipCount=0, writeSkipCount=0, processSkipCount=0, commitCount=0, rollbackCount=0, exitDescription=
10:13:16,092 WARN SimpleAsyncTaskExecutor-1 logger.stepExecutionEvents:150 - StepExecution: id=6,
version=2, name=step1, status=COMPLETED, exitStatus=COMPLETED, readCount=0, filterCount=0, writeCount=0
readSkipCount=0, writeSkipCount=0, processSkipCount=0, commitCount=1, rollbackCount=0, exitDescription=
```

To receive item, skip and chunk events

```
xd>job create --name myHttpJob --definition "httpJob" --deploy

xd>stream create --name itemEvents --definition "tap:job:myHttpJob.item >log" --deploy
xd>stream create --name skipEvents --definition "tap:job:myHttpJob.skip >log" --deploy
xd>stream create --name chunkEvents --definition "tap:job:myHttpJob.chunk >log" --deploy

xd>job launch myHttpJob
```

Note: The syntax for the tap that receives the item events: `tap:job:<job-name>.item`, for skip events: `tap:job:<job-name>.skip` and for chunk events: `tap:job:<job-name>.chunk`

To disable the default listeners

```
xd>job create --name myHttpJob --definition "httpJob --listeners=disable" --deploy
```

To select specific listeners

To select specific listeners, specify comma separated list in `--listeners` option. Following example illustrates the selection of job and step execution listeners only:

```
xd>job create --name myHttpJob --definition "httpJob --listeners=job,step" --deploy
```

Note: List of options are: job, step, item, chunk and skip The aggregated channel is registered if at least one of these default listeners are enabled.

For a complete example, please see the [Batch Notifications Sample](#) which is part of the [Spring XD Samples](#) repository.

8.8 Removing Batch Jobs

Batch Jobs can be deleted by executing:

```
xd:> job destroy helloSpringXD
```

Alternatively, one can just undeploy the job, keeping its definition for a future redeployment:

```
xd:> job undeploy helloSpringXD
```

8.9 Pre-Packaged Batch Jobs

Spring XD comes with several batch import and export modules. You can run them out of the box or use them as a basis for building your own custom modules.

Note regarding HDFS Configuration

To use the hdfs based jobs below, XD needs to have append enabled for hdfs. Update the `hdfs-site.xml` with the following settings:

```
<property>
  <name>dfs.support.append</name>
  <value>true</value>
</property>
```

Poll a Directory and Import CSV Files to HDFS (`filepollhdfs`)

This module is designed to be driven by a stream polling a directory. It imports data from CSV files and requires that you supply a list of named columns for the data using the `names` parameter. For example:

```
xd:> job create myjob --definition "filepollhdfs --names=forename,surname,address" --deploy
```

You would then use a stream with a file source to scan a directory for files and drive the job. A separate job will be started for each file found:

```
xd:> stream create csvStream --definition "file --ref=true --dir=/mycsvdir --pattern=*.csv >
queue:job:myjob" --deploy
```

The `filepollhdfs` job has the following options:

`commitInterval`

the commit interval to be used for the step (**int, default: 1000**)

`deleteFiles`

whether to delete files after successful import (**boolean, default: false**)

`directory`

the directory to write the file(s) to in HDFS (**String, default: /xd/<job name>**)

`fileExtension`

the file extension to use (**String, default: csv**)

`fileName`

the filename to use in HDFS (**String, default: <job name>**)

`fsUri`

the URI to use to access the Hadoop FileSystem (**String, default: \${spring.hadoop.fsUri}**)

`names`

the field names in the CSV file (**String, no default**)

`restartable`

whether the job should be restartable or not in case of failure (**boolean, default: false**)

`rollover`

the number of bytes to write before creating a new file in HDFS (**int, default: 1000000**)

Import CSV Files to JDBC (`filejdbc`)

A module which loads CSV files into a JDBC table using a single batch job. By default it uses the internal HSQL DB which is used by Spring Batch. Refer to [how module options are resolved](#) for further details on how to change defaults (one can of course always use `--foo=bar` notation in the job definition to achieve the same effect).

The `filejdbc` job has the following options:

abandonWhenPercentageFull

connections that have timed out wont get closed and reported up unless the number of connections in use are above the percentage (**int, default: 0**)

alternateUsernameAllowed

uses an alternate user name if connection fails (**boolean, default: false**)

commitInterval

the commit interval to be used for the step (**int, default: 1000**)

connectionProperties

connection properties that will be sent to our JDBC driver when establishing new connections (**String, no default**)

deleteFiles

whether to delete files after successful import (**boolean, default: false**)

delimiter

the delimiter for the delimited file (**String, default: ,**)

driverClassName

the JDBC driver to use (**String, no default**)

fairQueue

set to true if you wish that calls to getConnection should be treated fairly in a true FIFO fashion (**boolean, default: true**)

fsUri

the URI to use to access the Hadoop FileSystem (**String, default: \${spring.hadoop.fsUri}**)

initSQL

custom query to be run when a connection is first created (**String, no default**)

initialSize

initial number of connections that are created when the pool is started (**int, default: 0**)

initializeDatabase

whether the database initialization script should be run (**boolean, default: false**)

initializerScript

the name of the SQL script (in /config) to run if 'initializeDatabase' is set (**String, default: init_batch_import.sql**)

jdbcInterceptors

semicolon separated list of classnames extending org.apache.tomcat.jdbc.pool.JdbcInterceptor (**String, no default**)

jmxEnabled

register the pool with JMX or not (**boolean, default: true**)

logAbandoned

flag to log stack traces for application code which abandoned a Connection (**boolean, default: false**)

- maxActive**
maximum number of active connections that can be allocated from this pool at the same time (**int, default: 100**)
- maxAge**
time in milliseconds to keep this connection (**int, default: 0**)
- maxIdle**
maximum number of connections that should be kept in the pool at all times (**int, default: 100**)
- maxWait**
maximum number of milliseconds that the pool will wait for a connection (**int, default: 30000**)
- minEvictableIdleTimeMillis**
minimum amount of time an object may sit idle in the pool before it is eligible for eviction (**int, default: 60000**)
- minIdle**
minimum number of established connections that should be kept in the pool at all times (**int, default: 10**)
- names**
the field names in the CSV file (**String, no default**)
- partitionResultsTimeout**
time (ms) that the partition handler will wait for results (**long, default: 3600000**)
- password**
the JDBC password (**Password, no default**)
- removeAbandoned**
flag to remove abandoned connections if they exceed the `removeAbandonedTimeout` (**boolean, default: false**)
- removeAbandonedTimeout**
timeout in seconds before an abandoned connection can be removed (**int, default: 60**)
- resources**
the list of paths to import (Spring resources) (**String, no default**)
- restartable**
whether the job should be restartable or not in case of failure (**boolean, default: false**)
- suspectTimeout**
this simply logs the warning after timeout, connection remains (**int, default: 0**)
- tableName**
the database table to which the data will be written (**String, default: <job name>**)
- testOnBorrow**
indication of whether objects will be validated before being borrowed from the pool (**boolean, default: false**)
- testOnReturn**
indication of whether objects will be validated before being returned to the pool (**boolean, default: false**)

`testWhileIdle`

indication of whether objects will be validated by the idle object evictor (**boolean, default: false**)

`timeBetweenEvictionRunsMillis`

number of milliseconds to sleep between runs of the idle connection validation/cleaner thread (**int, default: 5000**)

`url`

the JDBC URL for the database (**String, no default**)

`useEquals`

true if you wish the ProxyConnection class to use String.equals (**boolean, default: true**)

`username`

the JDBC username (**String, no default**)

`validationInterval`

avoid excess validation, only run validation at most at this frequency - time in milliseconds (**long, default: 30000**)

`validationQuery`

sql query that will be used to validate connections from this pool (**String, no default**)

`validatorClassName`

name of a class which implements the org.apache.tomcat.jdbc.pool.Validator (**String, no default**)

The job should be defined with the `resources` parameter defining the files which should be loaded. It also requires a `names` parameter (for the CSV field names) and these should match the database column names into which the data should be stored. You can either pre-create the database table or the module will create it for you if you use `--initializeDatabase=true` when the job is created. The table initialization is configured in a similar way to the JDBC sink and uses the same parameters. The default table name is the job name and can be customized by setting the `tableName` parameter. As an example, if you run the command

```
xd:> job create myjob --definition "filejdbc --resources=file:///mycsvdir/*.csv --
names=forename,surname,address --tableName=people --initializeDatabase=true" --deploy
```

it will create the table "people" in the database with three varchar columns called "forename", "surname" and "address". When you launch the job it will load the files matching the resources pattern and write the data to this table. As with the `filepollhdfs` job, this module also supports the `deleteFiles` parameter which will remove the files defined by the `resources` parameter on successful completion of the job.

Launch the job using:

```
xd:> job launch myjob
```

Tip

The connection pool settings for xd are located in `servers.yml` (i.e. `spring.datasource.*`)

HDFS to JDBC Export (`hdfsjdbc`)

This module functions very similarly to the `filejdbc` one except that the resources you specify should actually be in HDFS, rather than the OS filesystem.

```
xd:> job create myjob --definition "hdfsjdbc --resources=/xd/data/*.csv --names=forename,surname,address
--tableName=people --initializeDatabase=true" --deploy
```

Launch the job using:

```
xd:> job launch myjob
```

The **hdfsjdbc** job has the following options:

abandonWhenPercentageFull

connections that have timed out wont get closed and reported up unless the number of connections in use are above the percentage (**int, default: 0**)

alternateUsernameAllowed

uses an alternate user name if connection fails (**boolean, default: false**)

commitInterval

the commit interval to be used for the step (**int, default: 1000**)

connectionProperties

connection properties that will be sent to our JDBC driver when establishing new connections (**String, no default**)

delimiter

the delimiter for the delimited file (**String, default: ,**)

driverClassName

the JDBC driver to use (**String, no default**)

fairQueue

set to true if you wish that calls to getConnection should be treated fairly in a true FIFO fashion (**boolean, default: true**)

fsUri

the URI to use to access the Hadoop FileSystem (**String, default: \${spring.hadoop.fsUri}**)

initSQL

custom query to be run when a connection is first created (**String, no default**)

initialSize

initial number of connections that are created when the pool is started (**int, default: 0**)

initializeDatabase

whether the database initialization script should be run (**boolean, default: false**)

initializerScript

the name of the SQL script (in /config) to run if 'initializeDatabase' is set (**String, default: init_batch_import.sql**)

jdbcInterceptors

semicolon separated list of classnames extending org.apache.tomcat.jdbc.pool.JdbcInterceptor (**String, no default**)

jmxEnabled

register the pool with JMX or not (**boolean, default: true**)

logAbandoned

flag to log stack traces for application code which abandoned a Connection (**boolean, default: false**)

maxActive

maximum number of active connections that can be allocated from this pool at the same time (**int, default: 100**)

maxAge

time in milliseconds to keep this connection (**int, default: 0**)

maxIdle

maximum number of connections that should be kept in the pool at all times (**int, default: 100**)

maxWait

maximum number of milliseconds that the pool will wait for a connection (**int, default: 30000**)

minEvictableIdleTimeMillis

minimum amount of time an object may sit idle in the pool before it is eligible for eviction (**int, default: 60000**)

minIdle

minimum number of established connections that should be kept in the pool at all times (**int, default: 10**)

names

the field names in the CSV file (**String, no default**)

password

the JDBC password (**Password, no default**)

removeAbandoned

flag to remove abandoned connections if they exceed the removeAbandonedTimeout (**boolean, default: false**)

removeAbandonedTimeout

timeout in seconds before an abandoned connection can be removed (**int, default: 60**)

resources

the list of paths to import (Spring resources) (**String, no default**)

restartable

whether the job should be restartable or not in case of failure (**boolean, default: false**)

suspectTimeout

this simply logs the warning after timeout, connection remains (**int, default: 0**)

tableName

the database table to which the data will be written (**String, default: <job name>**)

testOnBorrow

indication of whether objects will be validated before being borrowed from the pool (**boolean, default: false**)

testOnReturn

indication of whether objects will be validated before being returned to the pool (**boolean, default: false**)

testWhileIdle

indication of whether objects will be validated by the idle object evictor (**boolean, default: false**)

timeBetweenEvictionRunsMillis

number of milliseconds to sleep between runs of the idle connection validation/cleaner thread (**int, default: 5000**)

url

the JDBC URL for the database (**String, no default**)

useEquals

true if you wish the ProxyConnection class to use String.equals (**boolean, default: true**)

username

the JDBC username (**String, no default**)

validationInterval

avoid excess validation, only run validation at most at this frequency - time in milliseconds (**long, default: 30000**)

validationQuery

sql query that will be used to validate connections from this pool (**String, no default**)

validatorClassName

name of a class which implements the org.apache.tomcat.jdbc.pool.Validator (**String, no default**)

Tip

The connection pool settings for xd are located in servers.yml (i.e. `spring.datasource.*`)

JDBC to HDFS Import (`jdbchdfs`)

Performs the reverse of the previous module. The database configuration is the same as for `filejdbc` but without the initialization options since you need to already have the data to import into HDFS. When creating the job, you must either supply the select statement by setting the `sql` parameter, or you can supply both `tableName` and `columns` options (which will be used to build the SQL statement).

To import data from the database table `some_table`, you could use

```
xd> job create myjob --definition "jdbchdfs --sql='select col1,col2,col3 from some_table'" --deploy
```

You can customize how the data is written to HDFS by supplying the options `directory` (defaults to `/xd/(job name)`), `fileName` (defaults to job name), `rollover` (in bytes, default 1000000) and `fileExtension` (defaults to `csv`).

Launch the job using:

```
xd> job launch myjob
```

If you want to partition your job across multiple XD containers you can provide the `partitionColumn` and `partitions` option. When the job is launched the partitioner will query the database for the range

of values and evenly divide the load between the partitions. This assumes that there is an even distribution of column values in the table. When using the partitioning support you must also use the `tableName` and `columns` options instead of the `sql` option. This is so the partitioner can construct the queries with the appropriate where clauses for the different partitions.

An example of a partitioned job could look like this:

```
xd:> job create partitionedJob --definition "jdbcdfs --columns='id,col1,col2' --tableName=some_table --partitionColumn=id --partitions=4" --deploy
```

Note

When using the partitioning support you can not use the `sql` option. Use `tableName` and `columns` instead.

The **jdbcdfs** job has the following options:

abandonWhenPercentageFull

connections that have timed out wont get closed and reported up unless the number of connections in use are above the percentage (**int, default: 0**)

alternateUsernameAllowed

uses an alternate user name if connection fails (**boolean, default: false**)

columns

the column names to read from the supplied table (**String, default: ``**)

commitInterval

the commit interval to be used for the step (**int, default: 1000**)

connectionProperties

connection properties that will be sent to our JDBC driver when establishing new connections (**String, no default**)

delimiter

the delimiter for the delimited file (**String, default: ,**)

directory

the directory to write the file(s) to in HDFS (**String, default: /xd/<job name>**)

driverClassName

the JDBC driver to use (**String, no default**)

fairQueue

set to true if you wish that calls to `getConnection` should be treated fairly in a true FIFO fashion (**boolean, default: true**)

fileExtension

the file extension to use (**String, default: csv**)

fileName

the filename to use in HDFS (**String, default: <job name>**)

fsUri

the URI to use to access the Hadoop FileSystem (**String, default: \${spring.hadoop.fsUri}**)

initSQL

custom query to be run when a connection is first created (**String, no default**)

initialSize

initial number of connections that are created when the pool is started (**int, default: 0**)

jdbcInterceptors

semicolon separated list of classnames extending org.apache.tomcat.jdbc.pool.JdbcInterceptor (**String, no default**)

jmxEnabled

register the pool with JMX or not (**boolean, default: true**)

logAbandoned

flag to log stack traces for application code which abandoned a Connection (**boolean, default: false**)

maxActive

maximum number of active connections that can be allocated from this pool at the same time (**int, default: 100**)

maxAge

time in milliseconds to keep this connection (**int, default: 0**)

maxIdle

maximum number of connections that should be kept in the pool at all times (**int, default: 100**)

maxWait

maximum number of milliseconds that the pool will wait for a connection (**int, default: 30000**)

minEvictableIdleTimeMillis

minimum amount of time an object may sit idle in the pool before it is eligible for eviction (**int, default: 60000**)

minIdle

minimum number of established connections that should be kept in the pool at all times (**int, default: 10**)

partitionColumn

the column to use for partitioning, should be numeric and uniformly distributed (**String, default: ``**)

partitionResultsTimeout

time (ms) that the partition handler will wait for results (**long, default: 3600000**)

partitions

the number of partitions (**int, default: 1**)

password

the JDBC password (**Password, no default**)

removeAbandoned

flag to remove abandoned connections if they exceed the removeAbandonedTimeout (**boolean, default: false**)

removeAbandonedTimeout

timeout in seconds before an abandoned connection can be removed (**int, default: 60**)

restartable

whether the job should be restartable or not in case of failure (**boolean, default: false**)

rollover

the number of bytes to write before creating a new file in HDFS (**int, default: 1000000**)

sql

the SQL to use to extract data (**String, default: ``**)

suspectTimeout

this simply logs the warning after timeout, connection remains (**int, default: 0**)

tableName

the table to read data from (**String, default: ``**)

testOnBorrow

indication of whether objects will be validated before being borrowed from the pool (**boolean, default: false**)

testOnReturn

indication of whether objects will be validated before being returned to the pool (**boolean, default: false**)

testWhileIdle

indication of whether objects will be validated by the idle object evictor (**boolean, default: false**)

timeBetweenEvictionRunsMillis

number of milliseconds to sleep between runs of the idle connection validation/cleaner thread (**int, default: 5000**)

url

the JDBC URL for the database (**String, no default**)

useEquals

true if you wish the ProxyConnection class to use String.equals (**boolean, default: true**)

username

the JDBC username (**String, no default**)

validationInterval

avoid excess validation, only run validation at most at this frequency - time in milliseconds (**long, default: 30000**)

validationQuery

sql query that will be used to validate connections from this pool (**String, no default**)

validatorClassName

name of a class which implements the org.apache.tomcat.jdbc.pool.Validator (**String, no default**)

Tip

The connection pool settings for xd are located in servers.yml (i.e. `spring.datasource.*`)

HDFS to MongoDB Export (`hdfsmongodb`)

Exports CSV data from HDFS and stores it in a MongoDB collection which defaults to the job name. This can be overridden with the `collectionName` parameter. Once again, the field names should be defined by supplying the `names` parameter. The data is converted internally to a Spring XD `Tuple` and the collection items will have an `id` matching the tuple's UUID. You can override this by setting the `idField` parameter to one of the field names if desired.

An example:

```
xd:> job create myjob --definition "hdfsmongodb --resources=/data/*.log --
names=employeeId,forename,surname,address --idField=employeeId --collectionName=people" --deploy
```

The `hdfsmongodb` job has the following options:

`authenticationDatabaseName`

the MongoDB authentication database used for connecting (**String, default: ``**)

`collectionName`

the MongoDB collection to store (**String, default: <job name>**)

`commitInterval`

the commit interval to be used for the step (**int, default: 1000**)

`databaseName`

the MongoDB database name (**String, default: xd**)

`delimiter`

the delimiter for the delimited file (**String, default: ,**)

`fsUri`

the URI to use to access the Hadoop FileSystem (**String, default: `${spring.hadoop.fsUri}`**)

`host`

the MongoDB host to connect to (**String, default: localhost**)

`idField`

the name of the field to use as the identity in MongoDB (**String, no default**)

`names`

the field names in the CSV file (**String, no default**)

`password`

the MongoDB password used for connecting (**String, default: ``**)

`port`

the MongoDB port to connect to (**int, default: 27017**)

`resources`

the list of paths to import (Spring resources) (**String, no default**)

`restartable`

whether the job should be restartable or not in case of failure (**boolean, default: false**)

`username`

the MongoDB username used for connecting (**String, default: ``**)

writeConcern

the default MongoDB write concern to use (**WriteConcern, default: SAFE, possible values: NONE, NORMAL, SAFE, FSYNC_SAFE, REPLICAS_SAFE, JOURNAL_SAFE, MAJORITY**)

FTP to HDFS Export (ftphdfs)

Copies files from FTP directory into HDFS. Job is partitioned in a way that each separate file copy is executed on its own partitioned step.

An example which copies files:

```
job create --name ftphdfsjob --definition "ftphdfs --host=ftp.example.com --port=21" --deploy
job launch --name ftphdfsjob --params {"remoteDirectory":"/pub/files","hdfsDirectory":"/ftp"}
```

Full path is preserved so that above command would result files in HDFS shown below:

```
/ftp/pub/files
/ftp/pub/files/file1.txt
/ftp/pub/files/file2.txt
```

The **ftphdfs** job has the following options:

fsUri

the URI to use to access the Hadoop FileSystem (**String, default: \${spring.hadoop.fsUri}**)

host

the host name for the FTP server (**String, no default**)

partitionResultsTimeout

time (ms) that the partition handler will wait for results (**long, default: 3600000**)

password

the password for the FTP connection (**Password, no default**)

port

the port for the FTP server (**int, default: 21**)

restartable

whether the job should be restartable or not in case of failure (**boolean, default: false**)

username

the username for the FTP connection (**String, no default**)

Running Spark Application as a batch job (sparkapp)

A Spark Application can be deployed and launched from Spring XD as a batch job. SparkTasklet submits the Spark application into Spark cluster manager using **org.apache.spark.deploy.SparkSubmit**. Through this approach, you can also launch a Spark application with specific criteria via Spring XD stream (for instance: A real time scoring algorithm through MLlib spark job can be triggered based on the streaming data events). To get started, please refer to Spark examples here: <https://spark.apache.org/examples.html>.

Note

The current Spark release that is supported is Spark 1.2.1

Lets run some Spark examples as Spring XD batch jobs:

```
xd:>job create SparkPiExample --definition "sparkapp --appJar=<the location of spark-examples-1.2.1 jar>
--name=MyApp --master=<spark master url or local> --mainClass=org.apache.spark.examples.SparkPi" --
deploy
xd:>job launch SparkPiExample
```

```
xd:>job create JavaWordCountExample --definition "sparkapp --appJar=<the location
of spark-examples-1.2.1 jar> --name=MyApp --master=<spark master url or local> --
mainClass=org.apache.spark.examples.JavaWordCount --programArgs=<location of the file to count the
words>" --deploy
xd>job launch JavaWordCountExample
```

Once the job is launched, go to Spring XD admin-ui to verify the job results. Jobs # Executions # Select the job to verify that execution context holds the log for Spark application results. If you launch the Spark application through Spark Master, then the results and application status can be verified from SparkUI as well.

The **sparkapp** job has the following options:

appJar

path to a bundled jar that includes your application and its dependencies - excluding spark (**String, no default**)

conf

comma separated list of key value pairs as config properties (**String, default: ``**)

files

comma separated list of files to be placed in the working directory of each executor (**String, default: ``**)

mainClass

the main class for Spark application (**String, no default**)

master

the master URL for Spark (**String, default: local**)

name

the name of the Spark application (**String, default: ``**)

programArgs

program arguments for the application main class (**String, default: ``**)

Running Sqoop as a batch job (sqoop)

A Sqoop job can be deployed and launched from Spring XD as a batch job. The Sqoop job uses a `SqoopTasklet` and a `SqoopRunner` that submits a Sqoop job using **org.apache.sqoop.Sqoop.runTool**. The Spring XD Sqoop batch job aims to support most of the Sqoop functionality, but at this point we have tested a limited subset:

- import
- export
- codegen
- merge

- list-tables

Note

The current release supports Sqoop 1.4.5

The intention is to eventually support all features of the Sqoop tool including running Sqoop jobs saved in the Sqoop metastore. See [Sqoop User Guide](#) for full documentation of the Sqoop features.

We can test the Sqoop job by just listing the tables in the database:

```
xd:>job create sqoopListTables --definition "sqoop --command=list-tables" --deploy
xd:>job launch --name sqoopListTables
```

The definition contains the name of the provided job as `sqoop` and the `--command` option names the Sqoop command we want to run, which in this case is "list-tables".

Once the job is launched, go to Spring XD admin-ui to verify the job results. Jobs # Executions # Select the job to verify that step execution context holds the log for Sqoop Tool execution results. You should see some tables listed there. Since we didn't provide any connection arguments Spring XD will by default use the batch repository database for the Sqoop Tool execution. We could provide options specifying a different database using the `--url`, `--username` and `--password` options for the job:

```
xd:>job create sqoopListTables2 --definition "sqoop --command=import --url=jdbc:mysql://localhost:3306/test --username=myuser --password=mypasswd" --deploy
xd:>job launch --name sqoopListTables2
```

Here we connect to a local MySQL database. It's important to note that you need to provide the MySQL JDBC driver jar in the Spring XD lib directory for this to work.

There also is an option to specify connection arguments using the `--args` option. This allows you to use the same arguments that you are used to provide on the command line when running the Sqoop Tool directly. To connect to the same MySQL database as above using `--args` we would use:

```
xd:>job create sqoopListTables3 --definition "sqoop --command=list-tables --connect=jdbc:mysql://localhost:3306/test --username=myuser --password=mypasswd" --deploy
xd:>job launch --name sqoopListTables3
```

When importing data, you simply use "import" as the command to run. Here is an example:

```
xd:>job create sqoopImport1 --definition "sqoop --command=import --args='--table=MYTABLE' --url=jdbc:mysql://localhost:3306/test --username=myuser --password=mypasswd" --deploy
xd:>job launch --name sqoopImport1
```

In this example we provided the connection arguments using the `-args` option. We could also have used `--url`, `--username` and `--password` options like we did above for the "list-tables" example. The "import" command will use the `spring.hadoop.fsUri` that is specified when Spring XD starts up. You can override this by providing the `--fsUri` option when defining the job. The same is true for `spring.hadoop.resourceManagerHost` and `spring.hadoop.resourceManagerPort`. You can override the Spring XD configured values with `--resourceManagerHost` and `--resourceManagerPort` options.

For exports we use the "export" command. Here is an example:

```
xd:>job create sqoopExport1 --definition "sqoop --command=export --args='--table=NEWTABLE --export-dir=/user/xduser/MYTABLE' " --deploy
xd:>job launch --name sqoopExport1
```

Here we rely on the connection options to default to the same database used for the batch repository. Note that Sqoop requires that the table to export data into must already exist.

Note

If your Sqoop args are more complex, as is the case when you provide a query expression or a where clause, then you will need to use escaping for double quotes used within the `--args` option. A quick example of using a where clause:

```
job create sqoopComplexArgs1 --definition "sqoop --command=import --args='--table MYFILES --where \"ID < 390000\"' --target-dir /user/xduser/TEST --split-by ID"
```

(For this example we have omitted the equal sign for the individual Sqoop arguments within the `--args` option. Either style works fine.)

The **sqoop** job has the following options:

args

the arguments for the Sqoop command (**String, default: ``**)

command

the Sqoop command to run (**String, default: ``**)

driverClassName

the JDBC driver to use (**String, no default**)

fsUri

the URI to use to access the Hadoop FileSystem (**String, default: `${spring.hadoop.fsUri}`**)

password

the JDBC password (**Password, no default**)

resourceManagerHost

the Host for Hadoop's ResourceManager (**String, default: `${spring.hadoop.resourceManagerHost}`**)

resourceManagerPort

the Port for Hadoop's ResourceManager (**String, default: `${spring.hadoop.resourceManagerPort}`**)

url

the JDBC URL for the database (**String, no default**)

username

the JDBC username (**String, no default**)

Running gpload as a batch job (gpload)

The gpload utility can be deployed and launched from Spring XD as a batch job. The gpload job uses a `GploadTasklet` that submits a gpload job as an external process. The Spring XD gpload batch job aims to support most of the gpload functionality.

We need to provide the following required options:

- `gploadHome` - this must be the path to where `gpload` utility is installed. This is usually `/usr/local/greenplum-loaders-<version>`.
- `controlFile` - this file defines the `gpload` options in effect for this load job and is documented in the *Greenplum Load Tools Reference* documentation.
- `password` or `passwordFile` - you can either specify the password or provide a password file that must follow the general format for a PostgreSQL password file.

Here is an example of a basic load job definition. Please note that some options like host, port, database and username could have been specified in the control file as well.

The content of the control file:

```
VERSION: 1.0.0.1
GLOAD:
  INPUT:
    - SOURCE:
      FILE: [/home/demo/data/test_file.csv]
    - FORMAT: CSV
    - DELIMITER: ','
    - NULL_AS: '\N'
    - QUOTE: '"'
    - HEADER: FALSE
    - ENCODING: 'UTF8'
    - ERROR_LIMIT: 1000
    - ERROR_TABLE: public.err_table
  OUTPUT:
    - TABLE: demo.test
    - MODE: INSERT
  PRELOAD:
    - TRUNCATE: FALSE
    - REUSE_TABLES: FALSE
```

This is the command used to create and launch the job:

```
xd>job create myload --definition "gpload --gploadHome=/usr/local/greenplum-loaders-4.3.4.1-build-2 --
controlFile=/home/demo/basic.yml --host=pivhdsne --port=5432 --database=pivotal --username=gpadmin --
passwordFile=/home/demo/.pgpass" --deploy
xd>job launch --name myload
```

Once the job is launched, go to Spring XD admin-ui to verify the job results. Jobs # Executions # Select the job to verify that step execution context holds the log for `gpload` execution results.

We can override the file name for the source file by providing it as a job parameter like this:

```
job launch --name myload --params {"input.source.file":"/home/demo/data/inputfile2.csv"}
```

This allows us to define a stream to capture new files created in a specific directory:

```
xd>stream create loadFiles --definition "file --ref=true --dir=/home/demo/input --pattern='*.csv'
| transform --expression='{\"input.source.file\": \"'+#{'payload.getAbsolutePath()'+\"}' >
queue:job:myload" --deploy
```

Now, any new file created in that directory will launch a `gpload` job for that new file.

The **gpload** job has the following options:

`controlFile`

path to the `gpload` control file (**String, no default**)

database

the name of the database to load into **(String, no default)**

gploadHome

the gpload home location **(String, no default)**

host

the host name for the Greenplum master database server **(String, no default)**

options

the gpload options to use **(String, no default)**

password

the password to use when connecting **(String, no default)**

passwordFile

the location of the password file **(String, no default)**

port

the port for the Greenplum master database server **(Integer, no default)**

username

the username to connect as **(String, no default)**

9. Streams

9.1 Introduction

In Spring XD, a basic stream defines the ingestion of event driven data from a *source* to a *sink* that passes through any number of *processors*. Stream processing is performed inside the XD Containers and the deployment of stream definitions to containers is done via the XD Admin Server. The [Getting Started](#) section shows you how to start these servers and how to start and use the Spring XD shell

Sources, sinks and processors are predefined configurations of a *module*. Module definitions are found in the #0# directory.¹ Modules definitions are standard Spring configuration files that use existing Spring classes, such as [Input/Output adapters](#) and [Transformers](#) from Spring Integration that support general [Enterprise Integration Patterns](#).

A high level DSL is used to create stream definitions. The DSL to define a stream that has an http source and a file sink (with no processors) is shown below

```
http | file
```

The DSL mimics a UNIX pipes and filters syntax. Default values for ports and filenames are used in this example but can be overridden using `--` options, such as

```
http --port=8091 | file --dir=/tmp/httpdata/
```

To create these stream definitions you make an HTTP POST request to the XD Admin Server. More details can be found in the sections below.

9.2 Creating a Simple Stream

The XD Admin server⁵ exposes a full RESTful API for managing the lifecycle of stream definitions, but the easiest way to use the XD shell. Start the shell as described in the [Getting Started](#) section

New streams are created by posting stream definitions. The definitions are built from a simple DSL. For example, let's walk through what happens if we execute the following shell command:

```
xd:> stream create --definition "time | log" --name ticktock
```

This defines a stream named `ticktock` based off the DSL expression `time | log`. The DSL uses the "pipe" symbol `|`, to connect a source to a sink.

Then to deploy the stream execute the following shell command (or alternatively add the `--deploy` flag when creating the stream so that this step is not needed):

```
xd:> stream deploy --name ticktock
```

The stream server finds the `time` and `log` definitions in the modules directory and uses them to setup the stream. In this simple example, the `time` source simply sends the current time as a message each second, and the `log` sink outputs it using the logging framework.

¹Using the filesystem is just one possible way of storing module definitions. Other backends will be supported in the future, e.g. Redis.

⁵The server is implemented by the `AdminMain` class in the `spring-xd-dirt` subproject

```
processing module 'Module [name=log, type=sink]' from group 'ticktock' with index: 1
processing module 'Module [name=time, type=source]' from group 'ticktock' with index: 0
17:26:18,774 WARN ThreadPoolTaskScheduler-1 logger.ticktock:141 - Thu May 23 17:26:18 EDT 2013
```

If you would like to have multiple instances of a module in the stream, you can include a property with the `deploy` command:

```
xd:> stream deploy --name ticktock --properties "module.time.count=3"
```

You can also include a [SpEL Expression](#) as a `criteria` property for any module. That will be evaluated against the attributes of each currently available Container. Instances of the module will only be deployed to Containers for which the expression evaluates to true.

```
xd:> stream deploy --name ticktock --properties
"module.time.count=3,module.log.criteria=groups.contains('x')"
```

Important

See Section 9.9, “Module Labels”.

9.3 Deleting a Stream

You can delete a stream by issuing the `stream destroy` command from the shell:

```
xd:> stream destroy --name ticktock
```

9.4 Deploying and Undeploying Streams

Often you will want to stop a stream, but retain the name and definition for future use. In that case you can `undeploy` the stream by name and issue the `deploy` command at a later time to restart it.

```
xd:> stream undeploy --name ticktock
xd:> stream deploy --name ticktock
```

9.5 Other Source and Sink Types

Let’s try something a bit more complicated and swap out the `time` source for something else. Another supported source type is `http`, which accepts data for ingestion over HTTP POSTs. Note that the `http` source accepts data on a different port (default 9000) from the Admin Server (default 8080).

To create a stream using an `http` source, but still using the same `log` sink, we would change the original command above to

```
xd:> stream create --definition "http | log" --name myhttpstream --deploy
```

which will produce the following output from the server

```
processing module 'Module [name=log, type=sink]' from group 'myhttpstream' with index: 1
processing module 'Module [name=http, type=source]' from group 'myhttpstream' with index: 0
```

Note that we don’t see any other output this time until we actually post some data (using shell command)

```
xd:> http post --target http://localhost:9000 --data "hello"
xd:> http post --target http://localhost:9000 --data "goodbye"
```

and the stream will then funnel the data from the `http` source to the output log implemented by the `log` sink

```
15:08:01,676 WARN ThreadPoolTaskScheduler-1 logger.myhttpstream:141 - hello
15:08:12,520 WARN ThreadPoolTaskScheduler-1 logger.myhttpstream:141 - goodbye
```

Of course, we could also change the sink implementation. You could pipe the output to a file (`file`), to hadoop (`hdfs`) or to any of the other sink modules which are provided. You can also define your own [modules](#).

9.6 Simple Stream Processing

As an example of a simple processing step, we can transform the payload of the HTTP posted data to upper case using the stream definitions

```
http | transform --expression=payload.toUpperCase() | log
```

To create this stream enter the following command in the shell

```
xd> stream create --definition "http | transform --expression=payload.toUpperCase() | log" --name
myprocstream --deploy
```

Posting some data (using shell command)

```
xd> http post --target http://localhost:9000 --data "hello"
```

Will result in an uppercased *hello* in the log

```
15:18:21,345 WARN ThreadPoolTaskScheduler-1 logger.myprocstream:141 - HELLO
```

See the [Processors](#) section for more information.

9.7 DSL Syntax

In the examples above, we connected a source to a sink using the pipe symbol `|`. You can also pass parameters to the source and sink configurations. The parameter names will depend on the individual module implementations, but as an example, the `http` source module exposes a `port` setting which allows you to change the data ingestion port from the default value. To create the stream using port 8000, we would use

```
xd> stream create --definition "http --port=8000 | log" --name myhttpstream
```

If you know a bit about Spring configuration files, you can inspect the module definition to see which properties it exposes. Alternatively, you can read more in the [source](#) and [sink](#) documentation.

9.8 Advanced Features

In the examples above, simple module definitions are used to construct each stream. However, modules may be grouped together in order to avoid duplication and/or reduce the amount of chattiness over the messaging middleware. To learn more about that feature, refer to the [Composing Modules](#) section.

If directed graphs are needed instead of the simple linear streams described above, two features are relevant. First, named channels may be used as a way to combine multiple flows upstream and/or downstream from the channel. The behavior of that channel may either be queue-based or topic-based depending on what prefix is used ("queue:myqueue" or "topic:mytopic", respectively). To learn more, refer to the [Named Channels](#) section. Second, you may need to determine the output channel of a stream based on some information that is only known at runtime. To learn about such content-based routing, refer to the [Dynamic Router](#) section.

9.9 Module Labels

When a stream is comprised of multiple modules with the same name, they must be qualified with labels. See Section 4.5, “Labels”.

10. Modules

10.1 Introduction

Spring XD supports data ingestion by allowing users to define [streams](#). Streams are composed of *modules* which encapsulate a unit of work into a reusable component. A job in Spring XD must also be implemented as a module.

Modules are categorized by *type*, typically representing the role or function of the module. Current Spring XD module types include *source*, *sink*, *processor*, and *job*. The type determines how the modules may be composed in a stream, or used to deploy a batch job. More precisely:

- A source polls an external resource, or is triggered by an event and only provides output. The first module in a stream must be a source.
- A processor performs some type of task, using a message as input and produces a new message, so it requires both input and output.
- A sink consumes input messages and outputs data to an external resource to terminate the stream.
- A job module implements a Spring Batch job enabled for Spring XD.

Spring XD ships with a number of pre-built modules useful for assembling streams to perform common stream processing tasks using files, HDFS, Spark, Kafka, http, twitter, syslog, GemFire, and more. Users can easily assemble these modules into streams to build complex big data applications declaratively, without having to write Java code or know the underlying Spring products on which Spring XD is built.

However, if you are interested in extending Spring XD with your own modules, some knowledge of Spring, Spring Integration or Spring Batch is essential. The remainder of this document assumes the reader has some familiarity with these topics.

10.2 Creating a Module

This section provides some general details on implementing and packaging custom modules. For a quick start, take a look at the [si-dsl-module example](#) or dive into the examples of creating [source](#), [processor](#), [sink](#), and [job](#) modules.

Stream Modules

Sources, processors, and sinks are built using [Spring Integration](#) and are typically perform a single task that they may be easily reused in streams. Alternately, a custom module may be required to perform a specific function, such as integration with a legacy service. In Spring Integration terms:

- A *source* is a valid message flow that contains a direct channel named *output* which is fed by an inbound adapter, either configured with a poller, or triggered by an event.
- A *processor* is a valid message flow that contains a direct channel named *input* and a subscribable channel named *output* (direct or publish subscribe). It typically performs some type of transformation on the message, using its input channel's message to create a new message on its output channel.
- A *sink* is a valid message flow that contains a direct channel named *input* and an outbound adapter, or service activator used to provide the message to an external resource, HDFS for example.

For example, take a look at the [file source](#) which simply polls a directory using a file inbound adapter and [file sink](#) which appends an incoming message payload to a file using a file outbound adapter. On the surface, there is nothing special about these components. They are plain old Spring XML bean definition files.

Notice that modules adhere to an important convention: The input and output channels are always named *input* and *output*, in keeping with the KISS principle (let us know if you come up with some simpler names). The Spring XD runtime uses these names to bind these channels to the message transport.

Module Packaging

A module is a packaged component containing artifacts used to create a Spring application context. In general, a module is not aware of its runtime environment. Each module's application context is configured and connected to other modules via Plugins in order to support distributed processing. In this respect, modules may potentially be applied to purposes other than stream processing. The module types described here (source, processor, sink, and job) are specific to Spring XD, but the Module type is designed to act as a core component of any micro-service architecture built with Spring.

Physically, a Module is somewhat analogous to a *war* file in Servlet container. The Spring XD container configures and starts a module when it is deployed. Deploying a module in Spring XD terms means activating an instance for processing, not to be confused with deploying a web application in Servlet container. Consistent with the *war* analogy, a module has it's own class loader to load resources provided by the module, notably the files found in its *config* in its *lib* directories. Another feature in common with a war file is that web applications are installed in a configured location and conform to a standard layout. Artifacts are installed in a known location, either in expanded form or as a single archive file. Spring XD modules work the same way. Spring XD module layout has evolved significantly as new features have been added to support custom module development. This evolution has generally led to increased flexibility with respect to individual artifacts. However, the module's packaging structure is well defined:

```
<module_name>
  ### <local class files and resources, e.g. com/acme/...>
  ### config
  #   ### <any-name>.properties
  #   ### <any-name>.[xml | groovy] (optional)
  ### lib
  #   ### <dependent libraries not already in Spring XD class path (xd/lib)>
  #
```

For historical reasons, all modules included with Spring XD distribution are provided in expanded form and are commonly configured using XML bean definition files (`<module-name>.xml`) and property files (`<module-name>.properties`). This is subject to change as this convention is no longer required. Meanwhile the out-of-the-box modules provide copious examples of module configuration and packaging.

A module's contents typically includes:

- **Application context configuration:** If either `config/<any_name>.xml`, or `config/<any_name>.groovy` are present, this will be loaded by an [XmlBeanDefinitionReader](#) or [GroovyBeanDefinitionReader](#) to configure the application context. If using an `@Configuration` class, neither of these files should be present.
- **Module properties file:** If the module declares options (e.g. property placeholders whose values must be supplied for each instance when creating a stream), the properties file `config/`

`<any_name>.properties` may provide an `options_class` property containing the fully qualified class name of a Module Options Metadata class. Alternately the properties file may provide in-line Module Option descriptors (see [Module Options](#) below).

Note

As of Spring XD 1.1, the names of the module's bean definition resource (xml or groovy) and properties file are arbitrary. This provides additional flexibility over requiring a conventional file name, as has been the case in prior releases. Now the top level `config` directory is the convention. This carries the constraint that no other similar file types may be present in `config`. Multiple xml, groovy, or properties files matching the pattern, for example, `config/*.xml` will result in an exception. If you want to combine bean definitions from multiple resources, you may use `import` declarations and the imported resources must be somewhere else in the module's class path. This may be a subdirectory of `config` or any other arbitrary location.

If no configuration resource (`config/*.xml` or `config/*.groovy`) is present, Spring XD will expect a `base_packages` property containing a comma delimited list of package names to enable Spring component scanning scoped to the module.

- **Custom code:** Any root level `.class` files packaged as in a typical jar file. This could include an `@Configuration` class and dependent classes defined by the module.
- **Dependent jar files:** Any required runtime dependencies that are not already present in the Spring XD class path (`$XD_INSTALL_DIR/xd/lib`) must be provided in the module's `lib` directory.

As mentioned previously, a Spring XD module can be installed as an expanded directory tree or an archive. If the module requires dependent jars, which is the typical case, it may be packaged as an [uberjar](#) compatible with Spring Boot, and conforming to the above structure. The next section describes Spring XD's support for module packaging and development.

Creating a Module Project

Spring XD 1.1.x provides support for creating a module project to test and package the module with Maven or Gradle.

Configuring your Maven build

Start by setting the parent to `spring-xd-module-parent` in your `pom.xml`:

```
<parent>
  <groupId>org.springframework.xd</groupId>
  <artifactId>spring-xd-module-parent</artifactId>
  <version>1.1.0.RELEASE</version>
</parent>
```

Configuring your Gradle build

Start by adding the following to your `build.gradle` script

```
buildscript {
    repositories {
        ...
    }
    // Add the path of the Spring XD Module plugin
    dependencies {
        classpath("org.springframework.xd:spring-xd-module-plugin:1.1.0.RELEASE") //or a later release of
        the plugin
    }
}

//The Spring XD version is required by the plugin to pull in order to configure dependent libraries that
your module project will likely need.
ext {
    springXdVersion = '1.1.0.RELEASE' //or a later release of Spring XD
}

apply plugin: 'spring-xd-module'
```

Note

If your module has no internal dependencies, a plain old jar file conforming to the module packaging structure above will work. In this case, you may still benefit from using these build support tools to inherit common dependencies and automate tasks critical to in-container testing. An example of such a module project that does not use the parent pom is [here](#).

These build support tools provide the necessary Spring XD libraries to compile and test the module along with support for packaging your module as an uber-jar, using the respective Spring Boot plugin: [Spring Boot Maven Plugin](#) or the [Spring Boot Gradle Plugin](#).

As described in the above sections, the module must include any dependencies that are not already provided by the Spring XD container. These are loaded at runtime by the module class loader when the module is deployed. Missing jars in the module's lib directory will result in the dreaded `ClassNotFoundException`. Additionally, the module should typically not export different versions of libraries which are already on the Spring XD class path, as this can result in version conflicts and related class loading issues. Both build support tools configure the boot plugin with the `MODULE` layout and is configured to exclude any artifacts that are provided by Spring XD (which covers quite a lot). So you don't have to worry about it. There are two basic rules:

- The `MODULE` layout for Spring Boot packaging ensures `provided` dependencies will not be included in the uber-jar. The Spring XD module build support declares `spring-xd-dirt` as a provided dependency, as some of its classes are needed for module development.
- Any compile dependencies, transitive or declared for the module will be excluded from the uber-jar if they are also Spring XD runtime dependencies.

Note

In rare cases, it may be necessary to override the default exclusions. For example, if your module requires a different version of library that is on the Spring XD class path, you can override the boot maven plugin configuration in your pom, like so:

```

<parent>
  <groupId>org.springframework.xd</groupId>
  <artifactId>spring-xd-module-parent</artifactId>
  <version>1.1.0.BUILD-SNAPSHOT</version>
</parent>
<build>
  <plugins>
    <plugin>
      <groupId>org.springframework.boot</groupId>
      <artifactId>spring-boot-maven-plugin</artifactId>
      <configuration>
<!-- this is required to force the includes to come after the excludes and override -->
        <excludes>
          <exclude/>
        </excludes>
<!-- specify exactly what is included; again transitive dependencies are not included -->
        <includes>
          <include>
            <groupId>xmlpull</groupId>
            <artifactId>xmlpull</artifactId>
          </include>
        </includes>
      </configuration>
    </plugin>
  </plugins>
</build>

<dependencies>
  <dependency>
    <groupId>xmlpull</groupId>
    <artifactId>xmlpull</artifactId>
    <version>1.1.3.4d_b4_min</version>
  </dependency>
</dependencies>

```

The build support tools declare dependencies on `spring-xd-dirt` and `spring-xd-test` which provide some useful features for module development, including support for:

- Java defined [Module Options Metadata](#)
- In-container module testing - start an embedded single node container, deploy your module and validate the results.

Testing a Module Project

The sections [Creating a Source Module](#), [Creating a Processor Module](#), [Creating a Sink Module](#), and [Creating a Job Module](#) each reference working examples of custom module projects including in-container tests.

Note

As of Spring XD 1.1.x, the Spring XD message transport is loaded dynamically from a location given by `XD_HOME/lib/messagebus/<transport>`, according to the configured transport. This avoids having unnecessary dependencies on Spring XD's class path corresponding to unused transports. Thus, the embedded single node container used for testing modules must load the message bus libraries from the above location (typically local transport). Thus, these tools set `XD_HOME` to the project root directory and copy the local message bus jars to a top level `lib` directory to enable in-container tests using the respective build command. However, if you write such a test in your IDE and it fails with an exception message about not finding a message bus implementation, run

```
$mvn process-resources
```

or

```
./gradlew processTestResources
```

to install the local message bus. Currently testing modules for additional transports from a standalone module project is not supported out of the box.

To build the module:

```
$mvn clean package
```

or

```
./gradlew clean test bootRepackage
```

Note

Spring XD does not parse any embedded version in the jar name, a la Maven. `myModule-v1.jar` resolves to module named `myModule-v1`.

See the [si-dsl-module example](#) for a complete working example.

10.3 Registering a Module

Registering a module requires you to install to the Spring XD Module Registry. A Module must be registered before it may be deployed as part of a stream or job. Once you have packaged your module, following the instructions in the above section, you can register it using the Spring XD Shell `module upload` command:

```
xd:>module upload --file [path-to]/myModule-1.0.0.BUILD-SNAPSHOT.jar --name myModule --type processor
```

The Module Registry

A [module definition](#) requires the following attributes to uniquely define a module:

- name - the name of the component, normally a single word representing the purpose of the module. Examples are *file*, *http*, *syslog*.
- type - the module type, current Spring XD module types include *source*, *sink*, *processor*, and *job*

All modules included with Spring XD out-of-the-box are located in the `xd/modules` directory where Spring XD is installed. The Module Registry organizes modules by type in corresponding sub-directories, so a directory listing will look something like:

```
modules
  ### job
  ### processor
  ### sink
  ### source
```

Spring XD provides a strategy interface [ModuleRegistry](#) used to locate a module of a given name and type. Currently Spring XD implements a `ResourceModuleRegistry` which is configured to locate modules in the following locations in this order:

- The file path given by `xd.module.home` (`${xd.home}/modules` by default)
- `classpath:/modules/` (Spring XD does not provide any module definitions here)
- The file path given by `xd.customModule.home` (`${xd.home}/custom-modules` by default)

Custom Module Registry

Custom modules are located separately from out-of-the-box modules. The location is given by `xd.customModule.home` in `servers.yml`. The location defaults to `${xd.home}/custom-modules` but we strongly recommend setting this to an external location on a network file system if you are using custom modules in production. There are two reasons for doing this. First, custom modules must be accessible to all nodes on the Spring XD cluster, including the XD Admin node. This allows any container instance to deploy the module. Second, if custom modules are registered within the Spring XD installation, they will not survive an upgrade to the Spring XD distribution and will need to be reinstalled.

Note

An alternative way for specifying the location of custom modules via `servers.yml` is using the environment variable `XD_CUSTOMMODULE_HOME` that must point to the custom modules location.

In cases where you want to start e.g. a single-node runtime with a custom module location you can also define the environment variable right before the executable like this:

```
XD_CUSTOMMODULE_HOME=file\:/path/to/custom-modules bin/xd-singlenode
```

10.4 Module Class Loading

Modules use a separate class loader that will first load classes from jars in the module's `/lib` (and any class files located in the module's root path). If not found, the class will be loaded from the parent `ClassLoader` that Spring XD normally uses (which includes everything under `$XD_HOME/lib`). Still, there are a couple of caveats to be aware of:

- Avoid putting into the module's `lib/` directory any jar files that are already in Spring XD's class path or you may end up with `ClassCastException`s or other class loading issues.
- When using local transport, any class that is directly or indirectly referenced from the payload type of your messages (*i.e.* any type in transit from module to module) must be referenced by both the producing and consuming modules and thus should be installed into `xd/lib`.

Dynamic Module ClassLoader

Starting with Spring XD 1.2, a module can selectively add libraries from paths that are derived from module options. The aim is *e.g.* to support several alternative implementations in the same module. This works like the following:

1. In the module `.properties` file, specify a value for the `module.classloader` key. The default is `/lib/*.jar,/lib/*.zip`, which is consistent with what has been exposed earlier.
2. The value for that key is a comma separated list of paths (most certainly with Ant-style patterns) that will be looked for additional libraries to add to the module `ClassLoader` (in addition to the module "Archive" itself, which is always considered).

- a. paths that start with a / (as `/lib/*.jar` in the example above) are considered internal resources to the archives (e.g. nested jars in the über-jar)
 - b. paths that do *not* start with a / (and in particular paths that start with a protocol, such as `file:`) are loaded with a regular Spring resource pattern resolver
3. Those paths can contain placeholders of the form `${foo}`. Those will be resolved against the visible module options (and other inherited properties). Paths containing unresolvable placeholders are silently ignored.

This allows constructions like those (assuming for example that we want to create a `jpa` module that supports several JPA providers):

```
jpa.jar
+- config/
|   jpa.properties
+- lib/
|   +- hibernate/
|       |   hibernate-core-4.2.jar
|       |   other-hibernate-specific.jar
|   +- eclipse-link/
|       |   eclipse-link-2.5.0.jar
|       |   ...
|   +- some-common.jar
|   +- another-common.jar
```

And, in `jpa.properties`:

```
options_class = com.acme.jpa.JpaOptionsMetadata
module.classloader = /lib/*.jar, /lib/${provider}/*.jar, ${xd.home}/lib/jpa/${provider}/*.jpa
```

Where the metadata class includes a `provider` option (of type `String`) that will take e.g. the values `hibernate` or `eclipse-link`. Note the presence of a third `${xd.home}/lib/jpa/${provider}/*.jpa` entry that can be used for unforeseen provider implementations.

10.5 Module Options

Each module instance is configured using property placeholders which are bound to the module's options defined via [Module Options Metadata](#). Options may be required or optional, where optional properties must provide a default value. Module Options Metadata may be provided within the module's properties file or in a Java class provided by the module or one of its dependencies. In addition to binding module options to properties in the module's application context, options may also be used to activate Spring environment profiles.

For example, here is part of the Spring configuration for the `twittersearch` source that runs a query against Twitter:

```

<beans>

<bean class="org.springframework.integration.x.twitter.TwitterSearchChannelAdapter">
  <constructor-arg ref="twitterTemplate"/>
  <property name="readTimeout" value="${readTimeout}"/>
  <property name="connectTimeout" value="${connectTimeout}"/>
  <property name="autoStartup" value="false"/>
  <property name="outputChannel" ref="output"/>
  <property name="query" value="${query}" />
  <property name="language" value="${language}" />
  <property name="geocode" value="${geocode}" />
  <property name="resultType" value="${resultType}"/>
  <property name="includeEntities" value="${includeEntities}"/>
</bean>

<bean id="twitterTemplate" class="org.springframework.social.twitter.api.impl.TwitterTemplate">
  <constructor-arg value="${consumerKey}"/>
  <constructor-arg value="${consumerSecret}"/>
</bean>

<int:channel id="output"/>

</beans>

```

Note the Spring properties such as *query*, *language*, *consumerKey* and *consumerSecret*. Spring XD will bind values for all of these properties as provided as options for each module instance. The options exposed for this module are defined in [TwitterSearchOptionsMetadata.java](#)

For example, we can create two different streams, each using the *twittersearch* source providing different option values.

```
xd:> stream create --name tweettest --definition "twittersearch --query='java' | file"
```

and

```
xd:> stream create --name tweettest2 --definition "twittersearch --query='spring' --language=en --
consumerKey='mykey' --consumerSecret='mysecret' | file"
```

In addition to options, modules may reference Spring beans such that each module instance may inject a different implementation of a bean. The ability to deploy the same module definition with different configurations is only possible because each module is created in its own application context. This results in some very useful features, such as the ability to use standard bean ids such as *input* and *output* and simple property names without having to worry about naming collisions.

Observe the use of property placeholders with sensible defaults where possible in the above example. Sometimes, a sensible default is derived from the stream name, module name, or some other runtime context. For example, the file source requires a directory. An appropriate strategy is to define a common root path for XD input files (At the time of this writing it is `/tmp/xd/input/`. This is subject to change, but illustrates the point). A stream definition using the file source may specify the the directory name by providing a value for the *dir* option. If not provided, it will default to the stream name, which is contained in the `xd.stream.name` property bound to the module by the Spring XD runtime, see [file source metadata](#). The module `info` command illustrates this point:

```

xd:>module info --name source:file
Information about source module 'file':

  Option Name      Description
  Default          Type
  -----
  dir              the absolute path to the directory to monitor for files      /tmp/
xd/input/${xd.stream.name} String
  pattern          a filter expression (Ant style) to accept only files that match the pattern *
                  String
  preventDuplicates whether to prevent the same file from being processed twice   true
                  boolean
  ref              set to true to output the File object itself                  false
                  boolean
  fixedDelay       the fixed delay polling interval specified in seconds          5
                  int
  outputType       how this module should emit messages it produces                <none>
                  MimeType

```

Placeholders available to all modules

By convention, Spring XD defined properties are prefixed with *xd*. Below is the list of all available `${xd.xxx}` keys that module authors may use in their declaration.

Placeholder	Context	Meaning
<code>\${xd.stream.name}</code>	streams	the name of the stream the module lives in
<code>\${xd.job.name}</code>	jobs	the name of the job the module lives in
<code>\${xd.module.name}</code>	streams, jobs	the technical name of the module
<code>\${xd.module.type}</code>	streams, jobs	the type of the module
<code>\${xd.module.index}</code>	streams	the 0-based position of the module inside the stream
<code>\${xd.container.id}</code>	streams, jobs	the generated unique id of the container the module is deployed in
<code>\${xd.container.host}</code>	streams, jobs	the hostname of the container the module is deployed in
<code>\${xd.container.pid}</code>	streams, jobs	the process id of the container the module is deployed in
<code>\${xd.container.ip}</code>	streams, jobs	the IP address of the container the module is deployed in
<code>\${xd.container.<foo>}</code>	streams, jobs	the value of the custom attribute <code><foo></code> for the container

Using placeholders in stream definitions

One can also use the `${xd.xxx}` notation directly inside the DSL definition of a stream or a job. For example:

```
xd:>stream create foo --definition "http | filter --expression=\"'${xd.stream.name}'\" | log"
```

will only let messages that read "foo" pass through.

How module options are resolved

As we've seen so far, a module is a re-usable Spring Integration or Spring Batch application context that can be dynamically configured through the use of **module options**.

A module option is any value that may be configured within a stream or job definition. Preferably, the module provides [metadata](#) to describe the available options. This section explains how default values are computed for each module option.

In a nutshell, actual values are resolved from the following sources, in order of precedence:

1. values provided in the stream definition (e.g. `--foo=bar`)
2. platform-wide defaults (appearing e.g. in `.yml` and `.properties` files, see below)
3. defaults defined in the module's [metadata](#)

Going into more detail, the platform-wide defaults will resolve like so, assuming option `<optionname>` of a module `<modulename>` which is of type `<moduletype>`:

1. a **system property** named `<moduletype>.<modulename>.<optionname>`
2. an **environment variable** named `<moduletype>.<modulename>.<optionname>` (or `<MODULETYPE>_<MODULENAME>_<OPTIONNAME>`)
3. a key named `<optionname>` in the **properties** file `<root>/<moduletype>/<modulename>/<modulename>.properties`
4. a key named `<moduletype>.<modulename>.<optionname>` in the **YAML** file `<root>/<module-config>.yml`

where

`<root>`

is the value of the `xd.module.config.location` system property (driven by the `XD_MODULE_CONFIG_LOCATION` env var when using the canonical Spring XD shell scripts). This property defaults to `${xd.config.home}/modules/`

`<module-config>`

is the value of the `xd.module.config.name` system property (driven by the `XD_MODULE_CONFIG_NAME` env var). Defaults to `xd-module-config`

Note that YAML is particularly well suited for hierarchical configuration, so for example, instead of

```
source.file.dir: foo
source.file.pattern: *.txt

source.http.port: 1234
```

one can write

```
source:
  file:
    dir: foo
    pattern: *.txt
  http:
    port: 1234
```

Note that options in the `.properties` files can reference values that appear in the `modules.yml` file (this makes sharing common configuration easy). Also, the values that are used to configure the server runtimes (in `servers.yml`) are visible to `modules.yml` and `.properties` file (but the inverse is *not* true).

10.6 Composing Modules

As described above, a stream is defined as a sequence of modules, minimally a source module followed by a sink module. Sometimes streams may want share a common processing chain. For example, consider the following two streams:

```
stream1 = http | filter --expression=payload.contains('foo') | file
stream2 = file | filter --expression=payload.contains('foo') | file
```

Aside from the source, the two stream definitions are the same. Composite Modules provide a way to avoid this type of duplication by allowing the filter processor and file sink to be combined into a single composite module. Perhaps more importantly, composite modules may improve performance. Each module within a stream represents a unit of deployment. Therefore, `stream1` and `stream2`, as defined above, are each comprised of three such units (a source, a processor, and a sink). In a singlenode runtime with local transport, creating a composite module won't affect performance since the communication between modules in this case already uses in-memory channels. However, when deploying a stream to a distributed runtime environment, the communication between adjacent modules typically occurs via messaging middleware, as modules are, by default, distributed evenly among the available containers. Often a stream will perform better when adjacent modules are co-located and can avoid middleware "hops", and object marshalling. In such cases, composing modules allows the composite module to behave as a single "black box." In other words, if `"foo / bar"` are composed to create a new module named `"baz"`, the input and/or output to `"baz"` will still go over the middleware, but `foo` and `bar` will be co-located in a single container instance and wired to communicate via local memory.

Working with Composite Modules

To create a composite module, use the `module compose` shell command:

```
xd:> module compose foo --definition "filter --expression=payload.contains('foo') | file"
```

Then, to verify the new module composition was successful, check if it exists:

```
xd:>module list
Source          Processor      Sink           Job
-----
file            aggregator    aggregate-counter  filejdbc
gemfire         http-client   counter         ftpdfs
                (... )
trigger         splunk
twittersearch   tcp
twitterstream   throughput-sampler
time            (c) foo
```

Notice that the composed module shows up in the list of **sink** modules. That is because logically it acts as a sink: It provides an input channel (which is bridged to the filter processor's input channel), but it provides no output channel (since the file sink has no output). Also notice that the module has a small (c) prefixed to it, to indicate that it is a composed module.

If a module were composed of two processors, it would be classified as a processor:

```
xd:> module compose myprocessor --definition "splitter | filter --expression=payload.contains('foo')"
```

If a module were composed of a source and a processor, it would be classified as a source:

```
xd:> module compose mysource --definition "http | filter --expression=payload.contains('foo')"
```

Based on the logical type of the composed module, it may be used in a stream as if it were a simple module instance. For example, to redefine the two streams from the first problem case above, now that the *foo* sink module has been composed, you can issue the following shell commands:

```
xd:> stream create httpfoo --definition "http | foo" --deploy
xd:> stream create filefoo --definition "file --outputType=text/plain | foo" --deploy
```

To test the *httpfoo* stream, try the following:

```
xd:> http post --data hi
xd:> http post --data hifoo
```

The first message should have been ignored due to the filter, but the second one should exist in the file:

```
xd:> ! cat /tmp/xd/output/httpfoo.out
command is:cat /tmp/xd/output/httpfoo.out
hifoo
```

To test the *filefoo* stream, echo "foo" to a file in the */tmp/xd/input/filefoo* directory, then verify:

```
xd:> ! cat /tmp/xd/output/filefoo.out
command is:cat /tmp/xd/output/filefoo.out
foo
```

When you no longer need a composed module, you may delete it with the `module delete` shell command. However, if that composed module is currently being used in one or more stream definitions, Spring XD will not allow you to delete it until those stream definitions are destroyed. In this case, `module delete` will fail as shown below:

```
xd:> module delete --name sink:foo
16:51:37,349 WARN Spring Shell client.RestTemplate:566 - DELETE request for "http://localhost:9393/modules/sink/foo" resulted in 500 (Internal Server Error); invoking error handler
Command failed org.springframework.xd.rest.client.impl.SpringXDException: Cannot delete module sink:foo because it is used by [stream:filefoo, stream:httpfoo]
```

As you can see, the failure message shows which stream(s) depend upon the composed module you are trying to delete.

If you destroy both of those streams and try again, it will work:

```
xd:> stream destroy --name filefoo
Destroyed stream 'filefoo'
xd:> stream destroy --name httpfoo
Destroyed stream 'httpfoo'
xd:> module delete --name sink:foo
Successfully destroyed module 'foo' with type sink
```

When creating a module, if you duplicate the name of an existing module for the same type, you will receive an error. In the example below the user tried to compose a *tcp* module, however one already exists:

```
xd:>module compose tcp --definition "filter --expression=payload.contains('foo') | file"
14:52:27,781 WARN Spring Shell client.RestTemplate:566 - POST request for "http://
ec2-50-16-24-31.compute-1.amazonaws.com:9393/modules" resulted in 409 (Conflict); invoking error handler
Command failed org.springframework.xd.rest.client.impl.SpringXDException: There is already a module
named 'tcp' with type 'sink'
```

However, you can create a module for a given type even though a module of that name exists but as a different type. For example: I can create a sink module named *filter*, even though *filter* already exists as a processor.

Finally, it's worth mentioning that in some cases duplication may be avoided by reusing an actual stream rather than a composed module. This is possible when named channels are used in the source and/or sink position of a stream definition. For example, the same overall functionality as provided by the two streams above could also be achieved as follows:

```
xd> stream create foofilteredfile --definition "queue:foo > filter --expression=payload.contains('foo')
| file"
xd> stream create httpfoo --definition "http > queue:foo"
xd> stream create filefoo --definition "file > queue:foo"
```

This approach is more appropriate for use-cases where individual streams on either side of the named channel may need to be deployed or undeployed independently. Whereas the queue typed channel will load-balance across multiple downstream consumers, the *topic:* prefix may be used if broadcast behavior is needed instead. For more information about named channels, refer to the [Named Channels](#) section.

10.7 Getting Information about Modules

To view the available modules use the `module list` command. Modules appearing with a `(c)` marker are composed modules. For example:

```
xd:>module list
-----
Source           Processor           Sink                Job
-----
file             aggregator         aggregate-counter  filejdbc
gemfire          analytic-pmml     counter            ftphdfs
gemfire-cq       http-client       field-value-counter hdfsjdbc
http             bridge            file                hdfsmongodb
jms              filter            gauge               jdbchdfs
mail             json-to-tuple     gemfire-json-server filepollhdfs
mqtt             object-to-json    gemfire-server
post             script            jdbc
reactor-syslog   splitter          mail
reactor-tcp      transform         mqtt
syslog-tcp       (c) myfilter      rich-gauge
syslog-udp       splunk            splunk
tail             tcp                tcp
tcp              throughput-sampler
tcp-client       avro
trigger          hdfs
twittersearch    log
twitterstream    rabbit
rabbit           router
time
```

To get information about a particular module (such as what options it accepts), use the `module info --<module type>:<module name>` command. For example:

```
xd:>module info --name source:file
Information about source module 'file':

Option Name      Description
Default  Type
-----  -----
dir          the absolute path to the directory to monitor for files      <none>
  String
pattern      a filter expression (Ant style) to accept only files that match the pattern *
  String
outputType   how this module should emit messages it produces              <none>
  MimeType
preventDuplicates  whether to prevent the same file from being processed twice   true
  boolean
ref          set to true to output the File object itself                  false
  boolean
fixedDelay   the fixed delay polling interval specified in seconds          5
  int
```

11. Sources

11.1 Introduction

In this section we will show some variations on input sources. As a prerequisite start the XD Container as instructed in the [Getting Started](#) page.

The Sources covered are

- [HTTP](#)
- [SFTP](#)
- [Tail](#)
- [File](#)
- [Mail](#)
- [Twitter Search](#)
- [Twitter Stream](#)
- [Gemfire Source](#)
- [Gemfire CQ](#)
- [Syslog](#)
- [TCP](#)
- [TCP Client](#)
- [Reactor IP](#)
- [JMS](#)
- [RabbitMQ](#)
- [Time](#)
- [MQTT](#)
- [Stdout Capture](#)
- [Kafka](#)
- [JDBC](#)
- [MongoDB](#)
- [Trigger](#)

Future releases will provide support for other currently available Spring Integration Adapters. For information on how to adapt an existing Spring Integration Adapter for use in Spring XD see the section [Creating a Source Module](#).

The following sections show a mix of Spring XD shell and plain Unix shell commands, so if you are trying them out, you should open two separate terminal prompts, one running the XD shell and one to enter the standard commands for sending HTTP data, creating directories, reading files and so on.

11.2 HTTP

To create a stream definition in the server using the XD shell

```
xd:> stream create --name httpptest --definition "http | file" --deploy
```

Post some data to the http server on the default port of 9000

```
xd:> http post --target http://localhost:9000 --data "hello world"
```

See if the data ended up in the file

```
$ cat /tmp/xd/output/httpptest
```

To send binary data, set the `Content-Type` header to `application/octet-string`

```
$ curl --data-binary @foo.zip -H'Content-Type: application/octet-string' http://localhost:9000
```

HTTP with options

The `http` source has the following options:

`https`

true for https:// (**boolean, default: false**)

`maxContentLength`

the maximum allowed content length (**int, default: 1048576**)

`messageConverterClass`

the name of a custom `MessageConverter` class, to convert `HttpRequest` to `Message`; must have a constructor with a `'MessageBuilderFactory'` parameter (**String, default: `org.springframework.integration.x.http.NettyInboundMessageConverter`**)

`port`

the port to listen to (**int, default: 9000**)

`sslPropertiesLocation`

location (resource) of properties containing the location of the pkcs12 keyStore and pass phrase (**String, default: `classpath:httpSSL.properties`**)

Here is an example

```
xd:> stream create --name httpptest9020 --definition "http --port=9020 | file" --deploy
```

Post some data to the new port

```
xd:> http post --target http://localhost:9020 --data "hello world"
```

```
$ cat /tmp/xd/output/httpptest9020
hello world
```

Note

When using `https`, you need to provide a properties file that references a pkcs12 key store (containing the server certificate(s) and its passphrase). Setting `--https=true` enables `https://` and the module looks for the SSL properties in resource `classpath:httpSSL.properties`. This location can be overridden with the `--sslPropertiesLocation` property. For example:

```
xd:> stream create --name https9021 --definition "http --port=9021 --https=true --
sslPropertiesLocation=file:/secret/ssl.properties | file" --deploy
```

```
$ cat /secret/ssl.properties
keyStore=file:/secret/httpSource.p12
keyStore.passPhrase=secret
```

Since this properties file contains sensitive information, it will typically be secured by the operating system with the XD container process having read access.

11.3 SFTP

This source module supports transfer of files through SFTP protocol. While the transfer of files happens from `remote` directory to `local` directory, this module creates message from local directory file system.

Options

The **sftp** source has the following options:

`autoCreateLocalDir`

if local directory must be auto created if it does not exist (**boolean, default: true**)

`deleteRemoteFiles`

delete remote files after transfer (**boolean, default: false**)

`fixedDelay`

fixed delay in SECONDS to poll the remote directory (**int, default: 1**)

`host`

the remote host to connect to (**String, default: localhost**)

`localDir`

set the local directory the remote files are transferred to (**String, default: /tmp/xd/output**)

`passPhrase`

the passphrase to use (**String, default: ``**)

`password`

the password for the provided user (**String, default: ``**)

`pattern`

simple filename pattern to apply to the filter (**String, no default**)

`port`

the remote port to connect to (**int, default: 22**)

`privateKey`

the private key location (a valid Spring Resource URL) (**String, default: ``**)

regexPattern

filename regex pattern to apply to the filter **(String, no default)**

remoteDir

the remote directory to transfer the files from **(String, no default)**

tmpFileSuffix

extension to use when downloading files **(String, default: .tmp)**

user

the username to use **(String, no default)**

11.4 Tail

Make sure the default input directory exists

```
$ mkdir -p /tmp/xd/input
```

Create an empty file to tail (this is not needed on some platforms such as Linux)

```
$ touch /tmp/xd/input/tailtest
```

To create a stream definition using the XD shell

```
xd:> stream create --name tailtest --definition "tail | file" --deploy
```

Send some text into the file being monitored

```
$ echo blah >> /tmp/xd/input/tailtest
```

See if the data ended up in the file

```
$ cat /tmp/xd/output/tailtest
```

Tail with options

The **tail** source has the following options:

delay

how often (ms) to poll for new lines (forces use of the Apache Tailer, requires nativeOptions=) **(long, no default)**

fileDelay

on platforms that don't wait for a missing file to appear, how often (ms) to look for the file **(long, default: 5000)**

fromEnd

whether to tail from the end (true) or from the start (false) of the file (forces use of the Apache Tailer, requires nativeOptions=) **(boolean, no default)**

lines

the number of lines prior to the end of an existing file to tail; does not apply if 'nativeOptions' is provided **(int, default: 0)**

name

the absolute path of the file to tail **(String, default: /tmp/xd/input/<stream name>)**

nativeOptions

options for a native tail command; do not set and use 'end', 'delay', and/or 'reOpen' to use the Apache Tailer (**String, no default**)

reOpen

whether to reopen the file each time it is polled (forces use of the Apache Tailer, requires nativeOptions=") (**boolean, no default**)

Here is an example

```
xd:> stream create --name tailtest --definition "tail --name=/tmp/foo | file --name=bar" --deploy
```

```
$ echo blah >> /tmp/foo
```

```
$ cat /tmp/xd/output/bar
```

Tail Status Events

Some platforms, such as linux, send status messages to `stderr`. The tail module sends these events to a logging adapter, at WARN level; for example...

```
[message=tail: cannot open `/tmp/xd/input/tailtest' for reading: No such file or directory, file=/tmp/xd/input/tailtest]
[message=tail: `/tmp/xd/input/tailtest' has become accessible, file=/tmp/xd/input/tailtest]
```

11.5 File

The file source provides the contents of a File as a byte array by default but may be configured to provide the file reference itself.

To log the contents of a file create a stream definition using the XD shell

```
xd:> stream create --name filetest --definition "file | log" --deploy
```

The file source by default will look into a directory named after the stream, in this case `/tmp/xd/input/filetest`

Note the above will log the raw bytes. For text files, it is normally desirable to output the contents as plain text. To do this, set the `outputType` parameter:

```
xd:> stream create --name filetest --definition "file --outputType=text/plain | log" --deploy
```

For more details on the use of the `outputType` parameter see [Type Conversion](#)

Copy a file into the directory `/tmp/xd/input/filetest` and observe its contents being logged in the XD Container.

File with options

The **file** source has the following options:

dir

the absolute path to the directory to monitor for files (**String, default: /tmp/xd/input/<stream name>**)

fixedDelay

the fixed delay polling interval specified in seconds (**int, default: 5**)

pattern

a filter expression (Ant style) to accept only files that match the pattern (**String, default: ***)

preventDuplicates

whether to prevent the same file from being processed twice (**boolean, default: true**)

ref

set to true to output the File object itself (**boolean, default: false**)

The `ref` option is useful in some cases in which the file contents are large and it would be more efficient to send the file path.

11.6 Mail

Spring XD provides a source module for receiving emails, named `mail`. Depending on the protocol used, it can work by polling or receive mails as they become available.

Let's see an example:

```
xd:> stream create --name mailstream --definition "mail --host=imap.gmail.com --
username=your.user@gmail.com --password=secret | file" --deploy
```

Then send an email to yourself and you should see it appear inside a file at `/tmp/xd/output/mailstream`

The full list of options for the `mail` source is below:

The **mail** source has the following options:

charset

the charset used to transform the body of the incoming emails to Strings (**String, default: UTF-8**)

delete

whether to delete the emails once they've been fetched (**boolean, default: true**)

expression

a SpEL expression which filters which mail messages will be processed (non polling imap only) (**String, default: true**)

fixedDelay

the polling interval used for looking up messages (s) (**int, default: 60**)

folder

the folder to take emails from (**String, default: INBOX**)

host

the hostname of the mail server (**String, default: localhost**)

markAsRead

whether to mark emails as read once they've been fetched (**boolean, default: false**)

password

the password to use to connect to the mail server (**String, no default**)

port

the port of the mail server (**int, default: 25**)

protocol

the protocol to use to retrieve messages (**MailProtocol**, **default: imap**, **possible values: imap, imaps, pop3, pop3s**)

usePolling

whether to use polling or not (no polling works with imap(s) only) (**boolean**, **default: false**)

username

the username to use to connect to the mail server (**String**, **no default**)

Warning

Of special attention are the `markAsRead` and `delete` options, which by default will **delete** the emails once they are consumed. It is hard to come up with a sensible default option for this (please refer to the Spring Integration documentation section on mail handling for a discussion about this), so just be aware that the default for XD is to delete incoming messages.

11.7 Twitter Search

The `twittersearch` source runs a continuous query against Twitter.

The **`twittersearch`** source has the following options:

`connectTimeout`

the connection timeout for making a connection to Twitter (ms) (**int**, **default: 5000**)

`consumerKey`

a consumer key issued by twitter (**String**, **no default**)

`consumerSecret`

consumer secret corresponding to the consumer key (**String**, **no default**)

`geocode`

geo-location given as latitude,longitude,radius. e.g., '37.781157,-122.398720,1mi' (**String**, **default: ``**)

`includeEntities`

whether to include entities such as urls, media and hashtags (**boolean**, **default: true**)

`language`

language code e.g. 'en' (**String**, **default: ``**)

`query`

the query string (**String**, **default: ``**)

`readTimeout`

the read timeout for the underlying URLConnection to the twitter stream (ms) (**int**, **default: 9000**)

`resultType`

result type: recent, popular, or mixed (**ResultType**, **default: mixed**, **possible values: mixed, recent, popular**)

For information on how to construct a query, see the [Search API v1.1](#).

To get a `consumerKey` and `consumerSecret` you need to register a twitter application. If you don't already have one set up, you can create an app at the [Twitter Developers](#) site to get these credentials.

Tip

For both `twittersearch` and `twitterstream` you can put these keys in a module properties file instead of supplying them in the stream definition. If both sources share the same credentials, it is easiest to configure the required credentials in `config/modules/modules.yml`. Alternately, each module has its own properties file. For `twittersearch`, the file would be `config/modules/source/twittersearch/twittersearch.properties`.

To create and deploy a stream definition in the server using the XD shell:

```
xd:> stream create --name springone2gx --definition "twittersearch --query='#springone2gx' | file" --deploy
```

Let the `twittersearch` run for a little while and then check to see if some data ended up in the file

```
$ cat /tmp/xd/output/springone2gx
```

Note

Both `twittersearch` and `twitterstream` emit JSON in the [native Twitter format](#).

11.8 Twitter Stream

This source ingests data from Twitter's [streaming API v1.1](#). It uses the [sample and filter](#) stream endpoints rather than the full "firehose" which needs special access. The endpoint used will depend on the parameters you supply in the stream definition (some are specific to the filter endpoint).

You need to supply all keys and secrets (both consumer and `accessToken`) to authenticate for this source, so it is easiest if you just add these to `XD_HOME/config/modules/modules.yml` or `XD_HOME/config/modules/source/twitterstream/twitterstream.properties` file.

Stream creation is then straightforward:

```
xd:> stream create --name tweets --definition "twitterstream | file" --deploy
```

The `twitterstream` source has the following options:

`accessToken`

a valid OAuth access token (**String, no default**)

`accessTokenSecret`

an OAuth secret corresponding to the access token (**String, no default**)

`connectTimeout`

the connection timeout for making a connection to Twitter (ms) (**int, default: 5000**)

`consumerKey`

a consumer key issued by twitter (**String, no default**)

`consumerSecret`

consumer secret corresponding to the consumer key (**String, no default**)

`delimited`

set to true to get length delimiters in the stream data (**boolean, default: false**)

discardDeletes

set to discard 'delete' events (**boolean, default: true**)

filterLevel

controls which tweets make it through to the stream: none,low,or medium (**FilterLevel, default: none, possible values: none,low,medium**)

follow

comma delimited set of user ids whose tweets should be included in the stream (**String, default: ``**)

language

language code e.g. 'en' (**String, default: ``**)

locations

comma delimited set of latitude/longitude pairs to include in the stream (**String, default: ``**)

readTimeout

the read timeout for the underlying URLConnection to the twitter stream (ms) (**int, default: 9000**)

stallWarnings

set to true to enable stall warnings (**boolean, default: false**)

track

comma delimited set of terms to include in the stream (**String, default: ``**)

Note: The options available are pretty much the same as those listed in the [Twitter API docs](#) and unless otherwise stated, the accepted formats are the same.

Note

Both `twittersearch` and `twitterstream` emit JSON in the [native Twitter format](#).

11.9 GemFire Source

This source configures a client cache and client region, along with the necessary subscriptions enabled, in the XD container process along with a Spring Integration GemFire inbound channel adapter, backed by a CacheListener that outputs messages triggered by an external entry event on the region. By default the payload contains the updated entry value, but may be controlled by passing in a SpEL expression that uses the [EntryEvent](#) as the evaluation context.

Options

The **gemfire** source has the following options:

cacheEventExpression

an optional SpEL expression referencing the event (**String, default: newValue**)

host

host name of the cache server or locator (if useLocator=true). May be a comma delimited list (**String, no default**)

port

port of the cache server or locator (if useLocator=true). May be a comma delimited list (**String, no default**)

regionName

the name of the region for which events are to be monitored (**String, default: <stream name>**)

useLocator

indicates whether a locator is used to access the cache server (**boolean, default: false**)

Example

Use of the gemfire source requires an external process (or a separate stream) that creates or updates entries in a GemFire region configured for a cache server. Such events may feed a Spring XD stream. To support such a stream, the Spring XD container must join a GemFire distributed client-server grid as a client, creating a client region corresponding to an existing region on a cache server. The client region registers a cache listener via the Spring Integration GemFire inbound channel adapter. The client region and pool are configured for a subscription on all keys in the region.

The following example creates two streams: One to write http messages to a Gemfire region named *Stocks*, and another to listen for cache events and record the updates to a file. This works with the Cache Server and sample configuration included with the Spring XD distribution:

```
xd:> stream create --name gftest --definition "gemfire --regionName=Stocks | file" --deploy
xd:> stream create --name stocks --definition "http --port=9090 | gemfire-json-server --
regionName=Stocks --keyExpression=payload.getField('symbol')" --deploy
```

Now send some messages to the stocks stream.

```
xd:> http post --target http://localhost:9090 --data {"symbol":"FAKE","price":73}
xd:> http post --target http://localhost:9090 --data {"symbol":"FAKE","price":78}
xd:> http post --target http://localhost:9090 --data {"symbol":"FAKE","price":80}
```

Note

Avoid spaces in the JSON when using the shell to post data

As updates are posted to the cache you should see them captured in the output file:

```
$ cat /tmp/xd/output/gftest.out
{"symbol":"FAKE","price":73}
{"symbol":"FAKE","price":78}
{"symbol":"FAKE","price":80}
```

Note

The `useLocator` option is intended for integration with an existing GemFire installation in which the cache servers are configured to use locators in accordance with best practice. GemFire supports configuration of multiple locators (or direct server connections) and this is specified by supplying comma-delimited values for the `host` and `port` options. You may specify a single value for either of these options otherwise each value must contain the same size list. The following are examples are valid for multiple connection addresses:

```
gemfire --host=myhost --port=10334,10335
gemfire --host=myhost1,myhost2 --port=10334
gemfire --host=myhost1,myhost2,myhost3 --port=10334,10335,10336
```

The last example creates connections to myhost1:10334, myhost2:10335, myhost3:10336

Note

You may also configure default Gemfire connection settings for all gemfire modules in `config\modules.yml`:

```
gemfire:
  useLocator: true
  host: myhost1,myhost2
  port: 10334
```

Tip

If you are deploying on Java 7 or earlier and need to deploy more than 4 Gemfire modules be sure to increase the permsize of the singlenode or container. i.e. `JAVA_OPTS="-XX:PermSize=256m"`

Launching the XD GemFire Server

This source requires a cache server to be running in a separate process and its host and port, or a locator host and port must be configured. The XD distribution includes a GemFire server executable suitable for development and test purposes. This is a Java main class that runs with a Spring configured cache server. The configuration is passed as a command line argument to the server's main method. The configuration includes a cache server port and one or more configured region. XD includes a sample cache configuration called [cq-demo](#). This starts a server on port 40404 and creates a region named *Stocks*. A Logging cache listener is configured for the region to log region events.

Run Gemfire cache server by changing to the gemfire/bin directory and execute

```
$ ./gemfire-server ../config/cq-demo.xml
```

11.10 GemFire Continuous Query

Continuous query allows client applications to create a GemFire query using Object Query Language(OQL) and register a CQ listener which subscribes to the query and is notified every time the query's result set changes. The `gemfire_cq` source registers a CQ which will post CQEvent messages to the stream.

Options

The **gemfire-cq** source has the following options:

host

host name of the cache server or locator (if useLocator=true). May be a comma delimited list (**String, no default**)

port

port of the cache server or locator (if useLocator=true). May be a comma delimited list (**String, no default**)

query

the query string in Object Query Language (OQL) (**String, no default**)

useLocator

indicates whether a locator is used to access the cache server (**boolean, default: false**)

The example is similar to that presented for the [gemfire source](#) above, and requires an external cache server as described in the above section. In this case the query provides a finer filter on data events. In the example below, the `cqtest` stream will only receive events matching a single ticker symbol, whereas the `gftest` stream example above will receive updates to every entry in the region.

```
xd:> stream create --name stocks --definition "http --port=9090 | gemfire-json-server --
regionName=Stocks --keyExpression=payload.getField('symbol')" --deploy
xd:> stream create --name cqtest --definition "gemfire-cq --query='Select * from /Stocks where
symbol='FAKE'' | file" --deploy
```

Now send some messages to the stocks stream.

```
xd:> http post --target http://localhost:9090 --data {"symbol":"FAKE","price":73}
xd:> http post --target http://localhost:9090 --data {"symbol":"FAKE","price":78}
xd:> http post --target http://localhost:9090 --data {"symbol":"FAKE","price":80}
```

The `cqtest` stream is now listening for any stock quote updates for the ticker symbol `FAKE`. As updates are posted to the cache you should see them captured in the output file:

```
$ cat /tmp/xd/output/cqtest.out
{"symbol":"FAKE","price":73}
{"symbol":"FAKE","price":78}
{"symbol":"FAKE","price":80}
```

11.11 Syslog

Three syslog sources are provided: `reactor-syslog`, `syslog-udp`, and `syslog-tcp`. The `reactor-syslog` adapter uses `tcp` and builds upon the functionality available in the [Reactor](#) project and provides improved throughput over the `syslog-tcp` adapter.

The **reactor-syslog** source has the following options:

`port`

the port on which the system will listen for syslog messages (**int, default: 5140**)

The **syslog-udp** source has the following options:

`port`

the port on which to listen (**int, default: 5140**)

`rfc`

the format of the syslog (**String, default: 3164**)

The **syslog-tcp** source has the following options:

`nio`

use nio (recommend false for a small number of senders, true for many) (**boolean, default: false**)

`port`

the port on which to listen (**int, default: 5140**)

`rfc`

the format of the syslog (**String, default: 3164**)

To create a stream definition (using shell command)

```
xd:> stream create --name syslogtest --definition "reactor-syslog --port=5140 | file" --deploy
```

or

```
xd> stream create --name syslogtest --definition "syslog-udp --port=5140 | file" --deploy
```

or

```
xd> stream create --name syslogtest --definition "syslog-tcp --port=5140 | file" --deploy
```

(`--port` is not required when using the default 5140)

Send a test message to the syslog

```
logger -p local3.info -t TESTING "Test Syslog Message"
```

See if the data ended up in the file

```
$ cat /tmp/xd/output/syslogtest
```

Refer to your syslog documentation to configure the syslog daemon to forward syslog messages to the stream; some examples are:

UDP - Mac OSX (syslog.conf) and Ubuntu (rsyslog.conf)

```
*.* @localhost:5140
```

TCP - Ubuntu (rsyslog.conf)

```
$ModLoad omfwd
*.* @@localhost:5140
```

Restart the syslog daemon after reconfiguring.

11.12 TCP

The `tcp` source acts as a server and allows a remote party to connect to XD and submit data over a raw tcp socket.

To create a stream definition in the server, use the following XD shell command

```
xd> stream create --name tcptest --definition "tcp | file" --deploy
```

This will create the default TCP source and send data read from it to the `tcptest` file.

TCP is a streaming protocol and some mechanism is needed to frame messages on the wire. A number of decoders are available, the default being *CRLF* which is compatible with Telnet.

```
$ telnet localhost 1234
Trying ::1...
Connected to localhost.
Escape character is '^]'.
foo
^]

telnet> quit
Connection closed.
```

See if the data ended up in the file

```
$ cat /tmp/xd/output/tcptest
```

By default, the TCP module will emit a `byte[]`; to convert to a `String`, add `--outputType=text/plain` to the module definition.

TCP with options

The `tcp` source has the following options:

`bufferSize`

the size of the buffer (bytes) to use when encoding/decoding (**int, default: 2048**)

`charset`

the charset used when converting from bytes to `String` (**String, default: UTF-8**)

`decoder`

the decoder to use when receiving messages (**Encoding, default: CRLF, possible values: CRLF, LF, NULL, STXETX, RAW, L1, L2, L4**)

`nio`

whether or not to use NIO (**boolean, default: false**)

`port`

the port on which to listen (**int, default: 1234**)

`reverseLookup`

perform a reverse DNS lookup on the remote IP Address (**boolean, default: false**)

`socketTimeout`

the timeout (ms) before closing the socket when no data is received (**int, default: 120000**)

`useDirectBuffers`

whether or not to use direct buffers (**boolean, default: false**)

Available Decoders

Text Data

CRLF (default)

text terminated by carriage return (0x0d) followed by line feed (0x0a)

LF

text terminated by line feed (0x0a)

NULL

text terminated by a null byte (0x00)

STXETX

text preceded by an STX (0x02) and terminated by an ETX (0x03)

Text and Binary Data

RAW

no structure - the client indicates a complete message by closing the socket

L1

data preceded by a one byte (unsigned) length field (supports up to 255 bytes)

L2

data preceded by a two byte (unsigned) length field (up to $2^{16}-1$ bytes)

L4

data preceded by a four byte (signed) length field (up to $2^{31}-1$ bytes)

Examples

The following examples all use `echo` to send data to `netcat` which sends the data to the source.

The echo options `-en` allows echo to interpret escape sequences and not send a newline.

CRLF Decoder.

```
xd:> stream create --name tcptest --definition "tcp | file" --deploy
```

This uses the default (CRLF) decoder and port 1234; send some data

```
$ echo -en 'foobar\r\n' | netcat localhost 1234
```

See if the data ended up in the file

```
$ cat /tmp/xd/output/tcptest
```

LF Decoder.

```
xd:> stream create --name tcptest2 --definition "tcp --decoder=LF --port=1235 | file" --deploy
```

```
$ echo -en 'foobar\n' | netcat localhost 1235
```

```
$ cat /tmp/xd/output/tcptest2
```

NULL Decoder.

```
xd:> stream create --name tcptest3 --definition "tcp --decoder=NULL --port=1236 | file" --deploy
```

```
$ echo -en 'foobar\x00' | netcat localhost 1236
```

```
$ cat /tmp/xd/output/tcptest3
```

STXETX Decoder.

```
xd:> stream create --name tcptest4 --definition "tcp --decoder=STXETX --port=1237 | file" --deploy
```

```
$ echo -en '\x02foobar\x03' | netcat localhost 1237
```

```
$ cat /tmp/xd/output/tcptest4
```

RAW Decoder.

```
xd:> stream create --name tcptest5 --definition "tcp --decoder=RAW --port=1238 | file" --deploy
```

```
$ echo -n 'foobar' | netcat localhost 1238
```

```
$ cat /tmp/xd/output/tcptest5
```

L1 Decoder.

```
xd:> stream create --name tcptest6 --definition "tcp --decoder=L1 --port=1239 | file" --deploy
```

```
$ echo -en '\x06foobar' | netcat localhost 1239
```

```
$ cat /tmp/xd/output/tcptest6
```

L2 Decoder.

```
xd:> stream create --name tcptest7 --definition "tcp --decoder=L2 --port=1240 | file" --deploy
```

```
$ echo -en '\x00\x06foobar' | netcat localhost 1240
```

```
$ cat /tmp/xd/output/tcptest7
```

L4 Decoder.

```
xd:> stream create --name tcptest8 --definition "tcp --decoder=L4 --port=1241 | file" --deploy
```

```
$ echo -en '\x00\x00\x00\x06foobar' | netcat localhost 1241
```

```
$ cat /tmp/xd/output/tcptest8
```

Binary Data Example

```
xd:> stream create --name tcptest9 --definition "tcp --decoder=L1 --port=1242 | file --binary=true" --deploy
```

Note that we configure the `file` sink with `binary=true` so that a newline is not appended.

```
$ echo -en '\x08foo\x00bar\x0b' | netcat localhost 1242
```

```
$ hexdump -C /tmp/xd/output/tcptest9
00000000 66 6f 6f 00 62 61 72 0b          |foo.bar.|
00000008
```

11.13 TCP Client

The `tcp-client` source module uses raw tcp sockets, as does the `tcp` module but contrary to the `tcp` module, acts as a client. Whereas the `tcp` module will open a listening socket and wait for connections from a remote party, the `tcp-client` will initiate the connection to a remote server and emit as messages what that remote server sends over the wire. As an optional feature, the `tcp-client` can itself emit messages to the remote server, so that a simple conversation can take place.

TCP Client options

The `tcp-client` source has the following options:

bufferSize

the size of the buffer (bytes) to use when encoding/decoding (**int, default: 2048**)

charset

the charset used when converting from bytes to String (**String, default: UTF-8**)

close

whether to close the socket after each message (**boolean, default: false**)

decoder

the decoder to use when receiving messages (**Encoding, default: CRLF, possible values: CRLF, LF, NULL, STXETX, RAW, L1, L2, L4**)

encoder

the encoder to use when sending messages (**Encoding, default: CRLF, possible values: CRLF, LF, NULL, STXETX, RAW, L1, L2, L4**)

expression

a SpEL expression used to transform messages (**String, default: payload.toString()**)

fixedDelay

the rate at which stimulus messages will be emitted (seconds) (**int, default: 5**)

host

the remote host to connect to (**String, default: localhost**)

nio

whether or not to use NIO (**boolean, default: false**)

port

the port on the remote host to connect to (**int, default: 1234**)

propertiesLocation

the path of a properties file containing custom script variable bindings (**String, no default**)

reverseLookup

perform a reverse DNS lookup on the remote IP Address (**boolean, default: false**)

script

reference to a script used to process messages (**String, no default**)

socketTimeout

the timeout (ms) before closing the socket when no data is received (**int, default: 120000**)

useDirectBuffers

whether or not to use direct buffers (**boolean, default: false**)

variables

variable bindings as a comma delimited string of name-value pairs, e.g., 'foo=bar,baz=car' (**String, no default**)

Implementing a simple conversation

That "stimulus" counter concept bears some explanation. By default, the module will emit (at interval set by `fixedDelay`) an incrementing number, starting at 1. Given that the default is to use an expression of `payload.toString()`, this results in the module sending 1, 2, 3, ... to the remote server.

By using another expression, or more certainly a `script`, one can implement a simple conversation, assuming it is time based. As an example, let's assume we want to join some kind of chat server where one first needs to authenticate, then specify which rooms to join. Lastly, all clients are supposed to send some keepalive commands to make sure that the connection is open.

The following groovy script could be used to that effect:

```

def commands = ['', // index 0 is not used
'LOGIN user=johndoe', // first command sent
'JOIN weather',
'JOIN news',
'JOIN gossip'
]

// payload will contain an incrementing counter, starting at 1
if (commands.size > payload)
    return commands[payload] + "\n"
else
    return "PING\n" // send keep alive after 4th 'real' command

```

11.14 Reactor IP

The `reactor-ip` source acts as a server and allows a remote party to connect to XD and submit data over a raw TCP or UDP socket. The `reactor-ip` source differs from the standard `tcp` source in that it is based on the [Reactor Project](#) and can be configured to use the [LMAX Disruptor RingBuffer](#) library allowing for extremely high ingestion rates, e.g. ~ 1M/sec.

To create a stream definition use the following XD shell command

```

xd:> stream create --name tcpReactor --definition "reactor-ip | file" --deploy

```

This will create the reactor TCP source and send data read from it to the file named `tcpReactor`.

The **reactor-ip** source has the following options:

codec

codec used to transcode data (**String, default: `string`**)

dispatcher

type of Reactor Dispatcher to use (**String, default: `ringBuffer`**)

framing

method of framing the data (**String, default: `linefeed`**)

host

host to bind the server to (**String, default: `0.0.0.0`**)

lengthFieldLength

byte precision of the number used in the length field (**int, default: `4`**)

port

port to bind the server to (**int, default: `3000`**)

transport

whether to use TCP or UDP as a transport (**String, default: `tcp`**)

11.15 RabbitMQ

The "rabbit" source enables receiving messages from RabbitMQ.

The following example shows the default settings.

Configure a stream:

```
xd:> stream create --name rabbittest --definition "rabbit | file --binary=true" --deploy
```

This receives messages from a queue named `rabbittest` and writes them to the default file sink (`/tmp/xd/output/rabbittest.out`). It uses the default RabbitMQ broker running on localhost, port 5672.

The queue(s) must exist before the stream is deployed. We do not create the queue(s) automatically. However, you can easily create a Queue using the RabbitMQ web UI. Then, using that same UI, you can navigate to the "rabbittest" Queue and publish test messages to it.

Notice that the `file` sink has `--binary=true`; this is because, by default, the data emitted by the source will be bytes. This can be modified by setting the `content_type` property on messages to `text/plain`. In that case, the source will convert the message to a `String`; you can then omit the `--binary=true` and the file sink will then append a newline after each message.

To destroy the stream, enter the following at the shell prompt:

```
xd:> stream destroy --name rabbittest
```

RabbitMQ with Options

The **rabbit** source has the following options:

ackMode

the acknowledge mode (AUTO, NONE, MANUAL) (**String, default: AUTO**)

addresses

a comma separated list of 'host[:port]' addresses (**String, default: `#{spring.rabbitmq.addresses}`**)

concurrency

the minimum number of consumers (**int, default: 1**)

converterClass

the class name of the message converter (**String, default: `org.springframework.amqp.support.converter.SimpleMessageConverter`**)

enableRetry

enable retry; when retries are exhausted the message will be rejected; message disposition will depend on dead letter configuration (**boolean, default: `false`**)

initialRetryInterval

initial interval between retries (**int, default: 1000**)

mappedRequestHeaders

request message header names to be propagated to/from the adapter/gateway (**String, default: `STANDARD_REQUEST_HEADERS`**)

maxAttempts

maximum delivery attempts (**int, default: 3**)

maxConcurrency

the maximum number of consumers (**int, default: 1**)

<code>maxRetryInterval</code>	maximum retry interval (int, default: 30000)
<code>password</code>	the password to use to connect to the broker (String, default: <code>\${spring.rabbitmq.password}</code>)
<code>prefetch</code>	the prefetch size (int, default: 1)
<code>queues</code>	the queue(s) from which messages will be received (String, default: <code><stream name></code>)
<code>requeue</code>	whether rejected messages will be requeued by default (boolean, default: <code>true</code>)
<code>retryMultiplier</code>	retry interval multiplier (double, default: <code>2.0</code>)
<code>sslPropertiesLocation</code>	resource containing SSL properties (String, default: <code>\${spring.rabbitmq.sslProperties}</code>)
<code>transacted</code>	true if the channel is to be transacted (boolean, default: <code>false</code>)
<code>txSize</code>	the number of messages to process before acking (int, default: 1)
<code>useSSL</code>	true if SSL should be used for the connection (String, default: <code>\${spring.rabbitmq.useSSL}</code>)
<code>username</code>	the username to use to connect to the broker (String, default: <code>\${spring.rabbitmq.username}</code>)
<code>vhost</code>	the RabbitMQ virtual host to use (String, default: <code>\${spring.rabbitmq.virtual_host}</code>)

See the [RabbitMQ MessageBus Documentation](#) for more information about SSL configuration.

A Note About Retry

Note

With the default `ackMode` (**AUTO**) and `requeue` (**true**) options, failed message deliveries will be retried indefinitely. Since there is not much processing in the rabbit source, the risk of failure in the source itself is small. However, when using the `LocalMessageBus` or [Direct Binding](#), exceptions in downstream modules will be thrown back to the source. Setting `requeue` to **false** will cause messages to be rejected on the first attempt (and possibly sent to a Dead Letter Exchange/Queue if the broker is so configured). The `enableRetry` option allows configuration of retry parameters such that a failed message delivery can be retried and eventually discarded (or dead-lettered) when retries are exhausted. The delivery thread is suspended during the retry interval(s). Retry options are `enableRetry`, `maxAttempts`, `initialRetryInterval`, `retryMultiplier`, and `maxRetryInterval`. Message deliveries failing with a `MessageConversionException` (perhaps when using a custom

`converterClassName`) are never retried; the assumption being that if a message could not be converted on the first attempt, subsequent attempts will also fail. Such messages are discarded (or dead-lettered).

11.16 JMS

The "jms" source enables receiving messages from JMS.

The following example shows the default settings.

Configure a stream:

```
xd:> stream create --name jmstest --definition "jms | file" --deploy
```

This receives messages from a queue named `jmstest` and writes them to the default file sink (`/tmp/xd/output/jmstest`). It uses the default ActiveMQ broker running on localhost, port 61616.

To destroy the stream, enter the following at the shell prompt:

```
xd:> stream destroy --name jmstest
```

To test the above stream, you can use something like the following...

```
public class Broker {
    public static void main(String[] args) throws Exception {
        BrokerService broker = new BrokerService();
        broker.setBrokerName("broker");
        String brokerURL = "tcp://localhost:61616";
        broker.addConnector(brokerURL);
        broker.start();
        ConnectionFactory cf = new ActiveMQConnectionFactory(brokerURL);
        JmsTemplate template = new JmsTemplate(cf);
        while (System.in.read() >= 0) {
            template.convertAndSend("jmstest", "testFoo");
        }
    }
}
```

and `tail -f /tmp/xd/output/jmstest`

Run this as a Java application; each time you hit <enter> in the console, it will send a message to queue `jmstest`.

The out of the box configuration is setup to use ActiveMQ. To use another JMS provider you will need to update a few files in the XD distribution. There are sample files for HornetMQ in the distribution as an example for you to follow. You will also need to add the appropriate libraries for your provider in the JMS module lib directory or in the main XD lib directory.

JMS with Options

The `jms` source has the following options:

`acknowledge`

the session acknowledge mode (**String, default: auto**)

`clientId`

an identifier for the client, to be associated with a durable topic subscription (**String, no default**)

destination

the destination name from which messages will be received (**String, default: <stream name>**)

durableSubscription

when true, indicates the subscription to a topic is durable (**boolean, default: false**)

provider

the JMS provider (**String, default: activemq**)

pubSub

when true, indicates that the destination is a topic (**boolean, default: false**)

subscriptionName

a name that will be assigned to the topic subscription (**String, no default**)

Note

the selected broker requires an infrastructure configuration file `jms-<provider>-infrastructure-context.xml` in `modules/common`. This is used to declare any infrastructure beans needed by the provider. See the default (`jms-activemq-infrastructure-context.xml`) for an example. Typically, all that is required is a `ConnectionFactory`. The `activemq` provider uses a properties file `jms-activemq.properties` which can be found in the `config` directory. This contains the broker URL.

11.17 Time

The time source will simply emit a `String` with the current time every so often.

The **time** source has the following options:

fixedDelay

time delay between messages, expressed in `TimeUnits` (seconds by default) (**int, default: 1**)

format

how to render the current time, using `SimpleDateFormat` (**String, default: `yyyy-MM-dd HH:mm:ss`**)

initialDelay

an initial delay when using a fixed delay trigger, expressed in `TimeUnits` (seconds by default) (**int, default: 0**)

timeUnit

the time unit for the fixed and initial delays (**String, default: `SECONDS`**)

11.18 MQTT

The `mqtt` source connects to an `mqtt` server and receives telemetry messages.

Configure a stream:

```
xd:> stream create tcpTest --definition "mqtt --url='tcp://localhost:1883' --topics='xd.mqtt.test' |
log" --deploy
```

If you wish to use the MQTT Source defaults you can execute the command as follows:

```
xd:> stream create tcptest --definition "mqtt | log" --deploy
```

Options

The `mqtt` source has the following options:

binary

true to leave the payload as bytes (**boolean, default: false**)

charset

the charset used to convert bytes to String (when binary is false) (**String, default: UTF-8**)

cleanSession

whether the client and server should remember state across restarts and reconnects (**boolean, default: true**)

clientId

identifies the client (**String, default: `xd.mqtt.client.id.src`**)

connectionTimeout

the connection timeout in seconds (**int, default: 30**)

keepAliveInterval

the ping interval in seconds (**int, default: 60**)

password

the password to use when connecting to the broker (**String, default: `guest`**)

persistence

'memory' or 'file' (**String, default: `memory`**)

persistenceDirectory

file location when using 'file' persistence (**String, default: `/tmp/paho`**)

qos

the qos; a single value for all topics or a comma-delimited list to match the topics (**String, default: 0**)

topics

the topic(s) (comma-delimited) to which the source will subscribe (**String, default: `xd.mqtt.test`**)

url

location of the mqtt broker(s) (comma-delimited list) (**String, default: `tcp://localhost:1883`**)

username

the username to use when connecting to the broker (**String, default: `guest`**)

Note

The defaults are set up to connect to the RabbitMQ MQTT adapter on localhost.

11.19 Stdout Capture

There isn't actually a source named "stdin" but it is easy to capture stdin by redirecting it to a `tcp` source. For example if you wanted to capture the output of a command, you would first create the `tcp` stream, as above, using the appropriate sink for your requirements:

```
xd:> stream create tcpforstdout --definition "tcp --decoder=LF | log" --deploy
```

You can then capture the output from commands using the `netcat` command:

```
$ cat mylog.txt | netcat localhost 1234
```

11.20 Kafka

This source module ingests data from Kafka topic configuration.

The **kafka** source has the following options:

`autoOffsetReset`

strategy to reset the offset when there is no initial offset in ZK or if an offset is out of range (**AutoOffsetResetStrategy, default: `smallest`, possible values: `smallest`, `largest`**)

`encoding`

string encoder to translate bytes into string (**String, default: `UTF8`**)

`fetchMaxBytes`

max messages to attempt to fetch for each topic-partition in each fetch request (**int, default: `1048576`**)

`fetchMaxWait`

max wait time before answering the fetch request (**int, default: `100`**)

`fetchMinBytes`

the minimum amount of data the server should return for a fetch request (**int, default: `1`**)

`groupId`

kafka consumer configuration group id (**String, default: `<stream name>`**)

`initialOffsets`

comma separated list of `<partition>@<offset>` pairs indicating where the source should start consuming from (**String, default: ````**)

`kafkaOffsetTopicBatchSize`

maximum batched writes to offset topic, if Kafka offset strategy is chosen (**int, default: `200`**)

`kafkaOffsetTopicBatchTime`

maximum time for batching writes to offset topic, if Kafka offset strategy is chosen (**int, default: `1000`**)

`kafkaOffsetTopicBatchingEnabled`

enables batching writes to offset topic, if Kafka offset strategy is chosen (**boolean, default: `false`**)

`kafkaOffsetTopicMaxSize`

maximum size of reads from offset topic, if Kafka offset strategy is chosen (**int, default: `1048576`**)

`kafkaOffsetTopicName`

name of the offset topic, if Kafka offset strategy is chosen (**String, default: `<stream name>-${xd.module.name}-offsets`**)

`kafkaOffsetTopicRequiredAcks`

required acks for writing to the Kafka offset topic, if Kafka offset strategy is chosen (**int, default: `1`**)

kafkaOffsetTopicRetentionTime

retention time for dead records (tombstones), if Kafka offset strategy is chosen (**int, default: 60000**)

kafkaOffsetTopicSegmentSize

segment size of the offset topic, if Kafka offset strategy is chosen (**int, default: 262144000**)

offsetStorage

strategy for persisting offset values (**OffsetStorageStrategy, default: kafka, possible values: inmemory, redis, kafka**)

offsetUpdateCount

frequency, in number of messages, with which offsets are persisted, per concurrent processor, mutually exclusive with the time-based offset update option (use 0 to disable either) (**int, default: 0**)

offsetUpdateShutdownTimeout

timeout for ensuring that all offsets have been written, on shutdown (**int, default: 2000**)

offsetUpdateTimeWindow

frequency (in milliseconds) with which offsets are persisted mutually exclusive with the count-based offset update option (use 0 to disable either) (**int, default: 10000**)

partitions

comma separated list of partition IDs to listen on (**String, default: ``**)

queueSize

the maximum number of messages held internally and waiting for processing, per concurrent handler (**int, default: 1000**)

socketBufferBytes

socket receive buffer for network requests (**int, default: 2097152**)

socketTimeout

sock timeout for network requests in milliseconds (**int, default: 30000**)

streams

number of streams in the topic (**int, default: 1**)

topic

kafka topic name (**String, default: <stream name>**)

zkconnect

zookeeper connect string (**String, default: localhost:2181/kafka**)

zkconnectionTimeout

the max time the client waits to connect to ZK in milliseconds (**int, default: 6000**)

zksessionTimeout

zookeeper session timeout in milliseconds (**int, default: 6000**)

zksyncTime

how far a ZK follower can be behind a ZK leader in milliseconds (**int, default: 2000**)

Configure a stream:

```
xd:> stream create myKafkaSource --definition "kafka --zkconnect=localhost:2181 --topic=mytopic | log"
--deploy
```

11.21 JDBC Source

This source module supports the ability to ingest data directly from various databases. It does this by querying the database and sending the results as messages to the stream.

Configure a stream with a jdbc source using a query:

```
xd:> stream create foo --definition "jdbc --fixedDelay=1 --split=1 --url=jdbc:hsqldb:hsqldb://localhost:9101/mydb --query='select * from testfoo' |log" --deploy
```

In the example above the user will be polling the testfoo table to retrieve all the rows in the table once a second until the stream is undeployed or destroyed.

Configure a stream with a jdbc source using a query and update:

```
xd:> stream create foo --definition "jdbc --fixedDelay=1 --split=1 --url=jdbc:hsqldb:hsqldb://localhost:9101/mydb --query='select * from testfoo where tag = 0' --update='update testfoo set tag=1 where fooid in (:fooid)'|log" --deploy
```

In the example above the user will be polling the testfoo table to retrieve rows in the table that have a "tag" of zero. The update will set the value of tag to 1 for the rows that were retrieved, thus rows that have already been retrieved will not included in future queries.

The **jdbc** source has the following options:

abandonWhenPercentageFull

connections that have timed out wont get closed and reported up unless the number of connections in use are above the percentage (**int, default: 0**)

alternateUsernameAllowed

uses an alternate user name if connection fails (**boolean, default: false**)

connectionProperties

connection properties that will be sent to our JDBC driver when establishing new connections (**String, no default**)

driverClassName

the JDBC driver to use (**String, no default**)

fairQueue

set to true if you wish that calls to getConnection should be treated fairly in a true FIFO fashion (**boolean, default: true**)

fixedDelay

how often to poll for new messages (s) (**int, default: 5**)

initSQL

custom query to be run when a connection is first created (**String, no default**)

initialSize

initial number of connections that are created when the pool is started (**int, default: 0**)

jdbcInterceptors

semicolon separated list of classnames extending org.apache.tomcat.jdbc.pool.JdbcInterceptor (**String, no default**)

jmxEnabled

register the pool with JMX or not (**boolean, default: true**)

logAbandoned

flag to log stack traces for application code which abandoned a Connection (**boolean, default: false**)

maxActive

maximum number of active connections that can be allocated from this pool at the same time (**int, default: 100**)

maxAge

time in milliseconds to keep this connection (**int, default: 0**)

maxIdle

maximum number of connections that should be kept in the pool at all times (**int, default: 100**)

maxRowsPerPoll

max numbers of rows to process for each poll (**int, default: 0**)

maxWait

maximum number of milliseconds that the pool will wait for a connection (**int, default: 30000**)

minEvictableIdleTimeMillis

minimum amount of time an object may sit idle in the pool before it is eligible for eviction (**int, default: 60000**)

minIdle

minimum number of established connections that should be kept in the pool at all times (**int, default: 10**)

password

the JDBC password (**Password, no default**)

query

an SQL select query to execute to retrieve new messages when polling (**String, no default**)

removeAbandoned

flag to remove abandoned connections if they exceed the removeAbandonedTimeout (**boolean, default: false**)

removeAbandonedTimeout

timeout in seconds before an abandoned connection can be removed (**int, default: 60**)

split

whether to split the SQL result as individual messages (**boolean, default: true**)

suspectTimeout

this simply logs the warning after timeout, connection remains (**int, default: 0**)

testOnBorrow

indication of whether objects will be validated before being borrowed from the pool (**boolean, default: false**)

testOnReturn

indication of whether objects will be validated before being returned to the pool (**boolean, default: false**)

testWhileIdle

indication of whether objects will be validated by the idle object evictor (**boolean, default: false**)

timeBetweenEvictionRunsMillis

number of milliseconds to sleep between runs of the idle connection validation/cleaner thread (**int, default: 5000**)

update

an SQL update statement to execute for marking polled messages as 'seen' (**String, no default**)

url

the JDBC URL for the database (**String, no default**)

useEquals

true if you wish the ProxyConnection class to use String.equals (**boolean, default: true**)

username

the JDBC username (**String, no default**)

validationInterval

avoid excess validation, only run validation at most at this frequency - time in milliseconds (**long, default: 30000**)

validationQuery

sql query that will be used to validate connections from this pool (**String, no default**)

validatorClassName

name of a class which implements the org.apache.tomcat.jdbc.pool.Validator (**String, no default**)

11.22 MongoDB Source

The MongoDB source allows one to query a MongoDB collection and emit messages for each and every matching result. This source works by regularly polling MongoDB and emitting the result list, as independent objects. If `split` is set to `false`, the whole list is emitted as payload.

Here is an example:

```
xd:> stream create foo --definition "mongodb --collectionName=orders --fixedDelay=1 | log" --deploy
```

The **mongodb** source has the following options:

authenticationDatabaseName

the MongoDB authentication database used for connecting (**String, default: ``**)

collectionName

the MongoDB collection to read from (**String, default: <stream name>**)

databaseName

the MongoDB database name (**String, default: xd**)

- fixedDelay**
the time delay between polls for data, expressed in TimeUnits (seconds by default) **(int, default: 1000)**
- host**
the MongoDB host to connect to **(String, default: localhost)**
- initialDelay**
an initial delay when using a fixed delay trigger, expressed in TimeUnits (seconds by default) **(int, default: 0)**
- maxMessages**
the maximum number of messages to get at a time **(int, default: 1)**
- password**
the MongoDB password used for connecting **(String, default: ``)**
- port**
the MongoDB port to connect to **(int, default: 27017)**
- query**
the query to make to the mongo db **(String, default: {})**
- split**
whether to split the query result as individual messages **(boolean, default: true)**
- timeUnit**
the time unit for the fixed and initial delays **(String, default: SECONDS)**
- username**
the MongoDB username used for connecting **(String, default: ``)**

11.23 Trigger Source

The trigger source emits a message or messages according to the provided trigger configuration. The message payload is a simple literal value, provided in the `payload` property.

The **trigger** source has the following options:

- cron**
cron expression specifying when the trigger should fire **(String, no default)**
- date**
a one-time date when the trigger should fire; only applies if 'fixedDelay' and 'cron' are not provided **(String, default: The current time)**
- dateFormat**
the format specifying how the 'date' should be parsed **(String, default: MM/dd/yy HH:mm:ss)**
- fixedDelay**
time delay between executions, expressed in TimeUnits (seconds by default) **(Integer, no default)**
- initialDelay**
an initial delay when using a fixed delay trigger, expressed in TimeUnits (seconds by default) **(int, default: 0)**

payload

the message that will be sent when the trigger fires (**String, default: ``**)

timeUnit

the time unit for the fixed and initial delays (**String, default: SECONDS**)

12. Processors

12.1 Introduction

This section will cover the processors available out-of-the-box with Spring XD. As a prerequisite, start the XD Container as instructed in the [Getting Started](#) page.

The Processors covered are

- [Filter](#)
- [Transform](#)
- [Script](#)
- [Splitter](#)
- [Aggregator](#)
- [HTTP Client](#)
- [Shell Command](#)
- [JSON to Tuple](#)
- [Object to JSON](#)

See the section [Creating a Processor Module](#) for information on how to create custom processor modules.

12.2 Filter

Use the filter module in a [stream](#) to determine whether a Message should be passed to the output channel.

The **filter** processor has the following options:

expression

a SpEL expression used to transform messages (**String, default: `payload.toString()`**)

propertiesLocation

the path of a properties file containing custom script variable bindings (**String, no default**)

script

reference to a script used to process messages (**String, no default**)

variables

variable bindings as a comma delimited string of name-value pairs, e.g., 'foo=bar,baz=car' (**String, no default**)

Filter with SpEL expression

The simplest way to use the filter processor is to pass a SpEL expression when creating the stream. The expression should evaluate the message and return true or false. For example:

```
xd:> stream create --name filtertest --definition "http | filter --expression=payload=='good' | log" --
deploy
```

This filter will only pass Messages to the log sink if the payload is the word "good". Try sending "good" to the HTTP endpoint and you should see it in the XD log:

```
xd:> http post --target http://localhost:9000 --data "good"
```

Alternatively, if you send the word "bad" (or anything else), you shouldn't see the log entry.

Filter using jsonPath evaluation

As part of the SpEL expression you can make use of the pre-registered JSON Path function.

This filter example shows to pass messages to the output channel if they contain a specific JSON field matching a specific value.

```
xd:> stream create --name jsonfiltertest --definition "http --port=9002 | filter --
expression=#jsonPath(payload, '$.firstName').contains('John') | log" --deploy
```

Note: There is no space between payload JSON and the jsonPath in the expression

This filter will only pass Messages to the log sink if the JSON payload contains the *firstName* "John". Try sending this payload to the HTTP endpoint and you should see it in the XD log:

```
xd:> http post --target http://localhost:9002 --data "{\"firstName\":\"John\", \"lastName\":\"Smith\"}"
```

Alternatively, if you send a different *firstName*, you shouldn't see the log entry.

Here is another example usage of filter

```
filter --expression=#jsonPath(payload, '$.entities.hashtags[*].text').contains('obama')
```

This is an example that is operating on a JSON payload of tweets as consumed from the twitter search module.

Filter with Groovy Script

For more complex filtering, you can pass the location of a Groovy script using the *script* option. If you want to pass variable values to your script, you can statically bind values using the *variables* option or optionally pass the path to a properties file containing the bindings using the *propertiesLocation* option. All properties in the file will be made available to the script as variables. Note that *payload* and *headers* are implicitly bound to give you access to the data contained in a message.

Example:

Note

These features are common to all modules backed by Groovy scripts.

```
//custom-filter.groovy
return payload.size() > 4 || shortstrings=='true'
```

```
#custom-filter.properties
shortstrings=false
```

By default, Spring XD will search the classpath for *custom-filter.groovy* and *custom-filter.properties*. You can place the script in `${xd.home}/modules/processor/scripts` and the properties file in `${xd.home}/config` to make them available on the classpath. Alternatively, you can prefix the *script* and *properties-location* values with *file:* to load from the file system.

In the following stream definitions, the filter will pass only the first message:

```
xd>: stream create --name groovyfiltertest1 --definition "http --port=9001 | filter --
script=file:<absolute-path-to>/custom-filter.groovy --variables='shortstrings=false' | log" --deploy
Created and deployed new stream 'groovyfiltertest1'
xd>:http post --target http://localhost:9001 --data hello
xd:http post --target http://localhost:9001 --data hi
```

```
xd>: stream create --name groovyfiltertest2 --definition "http --port=9002 | filter --
script=file:<absolute-path-to>/custom-filter.groovy --propertiesLocation=file:<absolute-path-to>/custom-
filter.properties | log" --deploy
Created and deployed new stream 'groovyfiltertest2'
xd>:http post --target http://localhost:9002 --data hello
xd:http post --target http://localhost:9002 --data hi
```

In the following stream definitions, the filter will pass all messages (provided the payload type supports a `size()` method):

```
xd>: stream create --name groovyfiltertest1 --definition "http --port=9001 | filter --
script=file:<absolute-path-to>/custom-filter.groovy --variables='shortstrings=false' | log" --deploy
Created and deployed new stream 'groovyfiltertest1'
```

```
xd>: stream create --name groovyfiltertest2 --definition "http --port=9002 | filter --
script=file:<absolute-path-to>/custom-filter.groovy --variables='shortstring=false' --
propertiesLocation=file:<absolute-path-to>/custom-filter.properties | log" --deploy
Created and deployed new stream 'groovyfiltertest2'
```

Note the last example demonstrates that values specified in *variables* override values from *propertiesLocation*

Tip

The script is checked for updates every 60 seconds, so it may be replaced in a running system.

12.3 Transform

Use the transform module in a [stream](#) to convert a Message's content or structure.

The **transform** processor has the following options:

expression

a SpEL expression used to transform messages (**String**, **default:** `payload.toString()`)

propertiesLocation

the path of a properties file containing custom script variable bindings (**String**, **no default**)

script

reference to a script used to process messages (**String**, **no default**)

variables

variable bindings as a comma delimited string of name-value pairs, e.g., 'foo=bar,baz=car' (**String**, **no default**)

Transform with SpEL expression

The simplest way to use the transform processor is to pass a SpEL expression when creating the stream. The expression should return the modified message or payload. For example:

```
xd:> stream create --name transformtest --definition "http --port=9003 | transform --expression='FOO' | log" --deploy
```

This transform will convert all message payloads to the word "FOO". Try sending something to the HTTP endpoint and you should see "FOO" in the XD log:

```
xd:> http post --target http://localhost:9003 --data "some message"
```

As part of the SpEL expression you can make use of the pre-registered JSON Path function. The syntax is `#jsonPath(payload,<json path expression>)`

Transform with Groovy Script

For more complex transformations, you can pass the location of a Groovy script using the `script` option. If you want to pass variable values to your script, you can statically bind values using the `variables` option or optionally pass the path to a properties file containing the bindings using the `propertiesLocation` option. All properties in the file will be made available to the script as variables. Note that `payload` and `headers` are implicitly bound to give you access to the data contained in a message. See the [Filter](#) example for a more detailed discussion of script variables.

```
xd:> stream create --name groovytransformtest1 --definition "http --port=9004 | transform --script=custom-transform.groovy --variables="x=foo" | log" --deploy
```

```
xd:> stream create --name groovytransformtest2 --definition "http --port=9004 | transform --script=custom-transform.groovy --propertiesLocation=custom-transform.properties | log" --deploy
```

By default, Spring XD will search the classpath for `custom-transform.groovy` and `custom-transform.properties`. You can place the script in `${xd.home}/modules/processor/scripts` and the properties file in `${xd.home}/config` to make them available on the classpath. Alternatively, you can prefix the `script` and `properties-location` values with `file:` to load from the file system.

Tip

The script is checked for updates every 60 seconds, so it may be replaced in a running system.

12.4 Script

The script processor contains a *Service Activator* that invokes a specified Groovy script. This is a slightly more generic way to accomplish processing logic, as the provided script may simply terminate the stream as well as transform or filter Messages.

The **script** processor has the following options:

`propertiesLocation`

the path of a properties file containing custom script variable bindings (**String, no default**)

`script`

reference to a script used to process messages (**String, no default**)

variables

variable bindings as a comma delimited string of name-value pairs, e.g., 'foo=bar,baz=car' (**String, no default**)

To use the module, pass the location of a Groovy script using the *script* attribute. If you want to pass variable values to your script, you can statically bind values using the *variables* option or optionally pass the path to a properties file containing the bindings using the *propertiesLocation* option. All properties in the file will be made available to the script as variables. Note that *payload* and *headers* are implicitly bound to give you access to the data contained in a message. See the [Filter](#) example for a more detailed discussion of script variables.

```
xd:> stream create --name groovyprocessortest --definition "http --port=9006 | script --script=custom-processor.groovy --variables='x=foo' | log" --deploy
```

```
xd:> stream create --name groovyprocessortest --definition "http --port=9006 | script --script=custom-processor.groovy --propertiesLocation=custom-processor.properties | log" --deploy
```

By default, Spring XD will search the classpath for *custom-processor.groovy* and *custom-processor.properties*. You can place the script in `#{xd.home}/modules/processor/scripts` and the properties file in `#{xd.home}/config` to make them available on the classpath. Alternatively, you can prefix the *location* and *properties-location* values with *file:* to load from the file system.

Tip

The script is checked for updates every 60 seconds, so it may be replaced in a running system.

12.5 Splitter

The splitter module builds upon the concept of the same name in Spring Integration and allows the splitting of a single message into several distinct messages.

The **splitter** processor has the following options:

expression

a SpEL expression which would typically evaluate to an array or collection (**String, default: payload**)

Note

The default value for *expression* is *payload*, which actually does not split, unless the message is already a collection.

As part of the SpEL expression you can make use of the pre-registered JSON Path function. The syntax is `#jsonPath(payload,<json path expression>)`

Extract the value of a specific field

This splitter converts a JSON message payload to the value of a specific JSON field.

```
xd:> stream create --name jsontransformtest --definition "http --port=9005 | splitter --expression=#jsonPath(payload,'$.firstName') | log" --deploy
```

Try sending this payload to the HTTP endpoint and you should see just the value "John" in the XD log:

```
xd:> http post --target http://localhost:9005 --data '{"firstName":"John", "lastName":"Smith"}'
```

12.6 Aggregator

The aggregator module does the opposite of the splitter, and builds upon the concept of the same name found in Spring Integration. By default, it will consider all incoming messages from a stream to belong to the same group:

```
xd:> stream create --name aggregates --definition "http | aggregator --count=3 --
aggregation=T(org.springframework.util.StringUtils).collectionToDelimitedString(#this.![payload], ' ') |
log" --deploy
```

This uses a SpEL expression that will basically concatenate all payloads together, inserting a space character in between. As such,

```
xd:> http post --data Hello
xd:> http post --data World
xd:> http post --data !
```

would emit a single message whose contents is "Hello World !". This is because we set the aggregator release strategy to accumulate 3 messages.

The **aggregator** processor has the following options:

aggregation

how to construct the aggregated message (SpEL expression against a collection of messages)
(String, default: #this.![payload])

correlation

how to correlate messages (SpEL expression against each message) **(String, default: '<stream name>')**

count

the number of messages to group together before emitting a group **(int, default: 50)**

dbkind

which flavor of init scripts to use for the jdbc store (blank to attempt autodetection) **(String, no default)**

driverClassName

the jdbc driver to use when using the jdbc store **(String, no default)**

hostname

hostname of the redis instance to use as a store **(String, default: localhost)**

initializeDatabase

whether to auto-create the database tables for the jdbc store **(boolean, default: false)**

password

the password to use when using the jdbc or redis store **(String, default: ``)**

port

port of the redis instance to use as a store **(int, default: 6379)**

release

when to release messages (SpEL expression against a collection of messages accumulated so far)
(String, no default)

store

the kind of store to use to retain messages (**StoreKind**, default: `memory`, possible values: `memory`, `jdbc`, `redis`)

timeout

the delay (ms) after which messages should be released, even if the completion criteria is not met (**int**, default: `50000`)

url

the jdbc url to connect to when using the jdbc store (**String**, no default)

username

the username to use when using the jdbc store (**String**, no default)

Note

- Some of the options are only relevant when using a particular `store`
- The default `correlation` of '`<stream name>`' actually considers all messages to be correlated, since they all belong to the same stream.
- Using the `release` option overrides the `count` option (which is a simpler approach)
- The default for `aggregation` creates a new collection made of the payloads of the accumulated messages
- About the `timeout` option: due to the way it is implemented (see `MessageGroupStoreReaper` in the Spring Integration documentation), the actual observed delay may vary between `timeout` and `2*timeout`.

12.7 HTTP Client

The `http-client` processor acts as a client that issues HTTP requests to a remote server, submitting the message payload it receives to that server and in turn emitting the response it receives to the next module down the line.

For example, the following command will result in an immediate fetching of earthquake data and it being logged in the container:

```
xd:>stream create earthquakes --definition "trigger | http-client --url='\"http://earthquake.usgs.gov/earthquakes/feed/geojson/all/day\"' --httpMethod=GET | log" --deploy
```

Note

Please be aware that the `url` option above is actually a SpEL expression, hence the triple quotes. If you'd like to learn more about quotes, please read [the relevant documentation](#).

The **http-client** processor has the following options:

charset

the charset to use when in the Content-Type header when emitting Strings (**String**, default: `UTF-8`)

httpMethod

the http method to use when performing the request (**HttpMethod**, default: `POST`, possible values: `OPTIONS`, `GET`, `HEAD`, `POST`, `PUT`, `PATCH`, `DELETE`, `TRACE`, `CONNECT`)

mappedRequestHeaders

request message header names to be propagated to/from the adapter/gateway (**String, default: HTTP_REQUEST_HEADERS**)

mappedResponseHeaders

response message header names to be propagated from the adapter/gateway (**String, default: HTTP_RESPONSE_HEADERS**)

replyTimeout

the amount of time to wait (ms) for a response from the remote server (**int, default: 0**)

url

the url to perform an http request on (**String, no default**)

13. Shell

The `shell` processor forks an external process by running a shell command to launch a process written in any language. The process should implement a continual loop that waits for input from `stdin` and writes a result to `stdout` in a request-response manner. The process will be destroyed when the stream is undeployed. For example, it is possible to invoke a Python script within a stream in this manner. Since the shell processor relies on low-level stream processing there are some additional requirements:

- Input and output data are expected to be Strings, the `charset` is configurable.
- The shell process must not write out of band data to `stdout`, such as a start up message or prompt.
- Anything written to `stderr` will be logged as an ERROR in Spring XD but will not terminate the stream.
- Responses written to `stdout` must be terminated using the configured encoder (CRLF or `"\r\n"` is the default) for the module and must not exceed the configured `bufferSize`
- Any external software required to run the script must be installed on the container node to which the module is deployed.

Here is a simple Python example that echos the input:

```
#echo.py
import sys

#####
# Write data to stdout
#####
def send(data):
    sys.stdout.write(data)
    sys.stdout.flush()

#####
# Terminate a message using the default CRLF
#####
def eod():
    send("\r\n")

#####
# Main - Echo the input
#####

while True:
    try:
        data = raw_input()
        if data:
            send(data)
            eod()
    except EOFError:
        eod()
        break
```

Note

Spring XD provides additional Python programming support for handling basic stream processing, as shown above, see [xref:creating a Python module](#).

To try this example, copy the above script and save it to `echo.py`. Start Spring XD and create a stream:

```
xd:>stream create pytest --definition "time | shell --command='python <absolute-path-to>/echo.py' | log"
--deploy
Created and deployed new stream 'pytest'
```

you should see the time echoed in the log:

```
09:49:14,856 INFO task-scheduler-5 sink.pytest - 2014-10-10 09:49:14
09:49:15,860 INFO task-scheduler-1 sink.pytest - 2014-10-10 09:49:15
09:49:16,862 INFO task-scheduler-1 sink.pytest - 2014-10-10 09:49:16
09:49:17,864 INFO task-scheduler-1 sink.pytest - 2014-10-10 09:49:17
```

This script can be easily modified to do some actual work by providing a function that takes the input as an argument and returns a string. Then insert the function call:

```
while True:
    try:
        data = raw_input()
        if data:
            result = myfunc(data)
            send(result)
            eod()
    except EOFError:
        eod()
        break
```

The **shell** processor has the following options:

bufferSize

the size of the buffer (bytes) to use when encoding/decoding (**int, default: 2048**)

charset

the charset used when converting from String to bytes (**String, default: UTF-8**)

command

the shell command (**String, no default**)

encoder

the encoder to use when sending messages (**Encoding, default: CRLF, possible values: CRLF, LF, NULL, STXETX, RAW, L1, L2, L4**)

environment

additional process environment variables as comma delimited name-value pairs (**String, no default**)

redirectErrorStream

redirects stderr to stdout (**boolean, default: false**)

workingDir

the process working directory (**String, no default**)

13.1 JSON to Tuple

The `json-to-tuple` processor is able to transform a String representation of some JSON map into a [Tuple](#).

Here is a simple example:

```
xd:>stream create tuples --definition "http | json-to-tuple | transform --expression='payload.firstName
+ payload.lastName' | log" --deploy
xd:>http post --data '{"firstName": "Spring", "lastName": "XD}"'
```

Note

Transformation to Tuple can be used as an alternative or in addition of [Type Conversion](#), depending on your usecase.

The **json-to-tuple** processor has no particular option (in addition to options shared by all modules)

13.2 Object to JSON

The `object-to-json` processor can be used to convert any java Object to a JSON String.

In the following example, notice how the collection of three elements is transformed to JSON (in particular, the three Strings are surrounded by quotes):

```
xd:>stream create json --deploy --definition "http | aggregator --count | object-to-json | log"

xd:>http post --data hello
xd:>http post --data world
xd:>http post --data !
```

results in `["hello", "world", "!"]` appearing in the log.

The **object-to-json** processor has no particular option (in addition to options shared by all modules)

14. Sinks

14.1 Introduction

In this section we will show some variations on output sinks. As a prerequisite start the XD Container as instructed in the [Getting Started](#) page.

The Sinks covered are

- [Log](#)
- [File](#)
- [HDFS](#)
- [HDFS Dataset](#)
- [JDBC](#)
- [TCP](#)
- [Shell Command](#)
- [Mongo](#)
- [Mail](#)
- [RabbitMQ](#)
- [GemFire Server](#)
- [Splunk Server](#)
- [MQTT](#)
- [Dynamic Router](#)
- [Null Sink](#)
- [Redis](#)
- [Kafka](#)

See the section [Creating a Sink Module](#) for information on how to create sink modules using other Spring Integration Adapters.

14.2 Log

Probably the simplest option for a sink is just to log the data. The `log` sink uses the application logger to output the data for inspection. The log level is set to `WARN` and the logger name is created from the stream name. To create a stream using a `log` sink you would use a command like

```
xd:> stream create --name mylogstream --definition "http --port=8000 | log" --deploy
```

You can then try adding some data. We've used the `http` source on port 8000 here, so run the following command to send a message

```
xd:> http post --target http://localhost:8000 --data "hello"
```

and you should see the following output in the XD container console.

```
13/06/07 16:12:18 INFO sink.mylogstream: hello
```

The **log** sink has the following options:

expression

the expression to be evaluated for the log content; use '#root' to log the full message (**String**, **default: payload**)

level

the log level (**String**, **default: INFO**)

name

the name of the log category to log to (will be prefixed by 'xd.sink.') (**String**, **default: <stream name>**)

Here are some examples explaining the above options:

The logger name is the sink name prefixed with the string `xd.sink..` The sink name is the same as the stream name by default, but you can set it by passing the `--name` parameter

```
xd:> stream create --name myotherlogstream --definition "http --port=8001 | log --name=mylogger" --
deploy
```

The log level is `INFO` by default; this can be changed with the `--level` property (`FATAL`, `ERROR`, `WARN`, `INFO`, `DEBUG`, or `TRACE`)

```
xd:> stream create --name mylogstream --definition "http --port=8001 | log --level=WARN" --deploy
```

By default, the message payload is logged; this can be changed with the `--expression` property (e.g. `payload.foo` to log some property `foo` of the payload, or `#root` to log the entire message)

```
xd:> stream create --name mylogstream --definition "http --port=8001 | log --expression=#root" --deploy
```

14.3 File Sink

Another simple option is to stream data to a file on the host OS. This can be done using the `file` sink module to create a [stream](#).

```
xd:> stream create --name myfilestream --definition "http --port=8000 | file" --deploy
```

We've used the `http` source again, so run the following command to send a message

```
xd:> http post --target http://localhost:8000 --data "hello"
```

The `file` sink uses the stream name as the default name for the file it creates, and places the file in the `/tmp/xd/output/` directory.

```
$ less /tmp/xd/output/myfilestream
hello
```

You can customize the behavior and specify the `name` and `dir` options of the output file. For example

```
xd:> stream create --name otherfilestream --definition "http --port=8000 | file --name=myfile --dir=/
some/custom/directory" --deploy
```

File with Options

The **file** sink has the following options:

binary

if false, will append a newline character at the end of each line (**boolean, default: false**)

charset

the charset to use when writing a String payload (**String, default: UTF-8**)

dir

the directory in which files will be created (**String, default: /tmp/xd/output/**)

mode

what to do if the file already exists (**Mode, default: APPEND, possible values: APPEND, REPLACE, FAIL, IGNORE**)

name

filename pattern to use (**String, default: <stream name>**)

suffix

filename extension to use (**String, no default**)

14.4 Hadoop (HDFS)

If you do not have Hadoop installed, you can install Hadoop as described in our [separate guide](#). Spring XD supports 4 Hadoop distributions, see [using Hadoop](#) for more information on how to start Spring XD to target a specific distribution.

Once Hadoop is up and running, you can then use the `hdfs` sink when creating a [stream](#)

```
xd:> stream create --name myhdfsstream1 --definition "time | hdfs" --deploy
```

In the above example, we've scheduled `time` source to automatically send ticks to `hdfs` once in every second. If you wait a little while for data to accumulate you can then list the files in the hadoop filesystem using the shell's built in `hadoop fs` commands. Before making any access to HDFS in the shell you first need to configure the shell to point to your name node. This is done using the `hadoop config` command.

```
xd:>hadoop config fs --namenode hdfs://localhost:8020
```

In this example the `hdfs` protocol is used but you may also use the `webhdfs` protocol. Listing the contents in the output directory (named by default after the stream name) is done by issuing the following command.

```
xd:>hadoop fs ls /xd/myhdfsstream1
Found 1 items
-rw-r--r--  3 jvalkealahti supergroup          0 2013-12-18 18:10 /xd/myhdfsstream1/
myhdfsstream1-0.txt.tmp
```

While the file is being written to it will have the `tmp` suffix. When the data written exceeds the rollover size (default 1GB) it will be renamed to remove the `tmp` suffix. There are several options to control the in use file naming options. These are `--inUsePrefix` and `--inUseSuffix` set the file name prefix and suffix respectfully.

When you destroy a stream

```
xd:>stream destroy --name myhdfsstream1
```

and list the stream directory again, in use file suffix doesn't exist anymore.

```
xd:>hadoop fs ls /xd/myhdfsstream1
Found 1 items
-rw-r--r--  3 jvalkealahti supergroup      380 2013-12-18 18:10 /xd/myhdfsstream1/myhdfsstream1-0.txt
```

To list the contents of a file directly from a shell execute the hadoop cat command.

```
xd:> hadoop fs cat /xd/myhdfsstream1/myhdfsstream1-0.txt
2013-12-18 18:10:07
2013-12-18 18:10:08
2013-12-18 18:10:09
...
```

In the above examples we didn't yet go through why the file was written in a specific directory and why it was named in this specific way. Default location of a file is defined as `/xd/<stream name>/<stream name>-<rolling part>.txt`. These can be changed using options `--directory` and `--fileName` respectively. Example is shown below.

```
xd:>stream create --name myhdfsstream2 --definition "time | hdfs --directory=/xd/tmp --fileName=data" --
deploy
xd:>stream destroy --name myhdfsstream2
xd:>hadoop fs ls /xd/tmp
Found 1 items
-rw-r--r--  3 jvalkealahti supergroup      120 2013-12-18 18:31 /xd/tmp/data-0.txt
```

It is also possible to control the size of a files written into HDFS. The `--rollover` option can be used to control when file currently being written is rolled over and a new file opened by providing the rollover size in bytes, kilobytes, megatypes, gigabytes, and terabytes.

```
xd:>stream create --name myhdfsstream3 --definition "time | hdfs --rollover=100" --deploy
xd:>stream destroy --name myhdfsstream3
xd:>hadoop fs ls /xd/myhdfsstream3
Found 3 items
-rw-r--r--  3 jvalkealahti supergroup      100 2013-12-18 18:41 /xd/myhdfsstream3/myhdfsstream3-0.txt
-rw-r--r--  3 jvalkealahti supergroup      100 2013-12-18 18:41 /xd/myhdfsstream3/myhdfsstream3-1.txt
-rw-r--r--  3 jvalkealahti supergroup      100 2013-12-18 18:41 /xd/myhdfsstream3/myhdfsstream3-2.txt
```

Shortcuts to specify sizes other than bytes are written as `--rollover=64M`, `--rollover=512G` or `--rollover=1T`.

The stream can also be compressed during the write operation. Example of this is shown below.

```
xd:>stream create --name myhdfsstream4 --definition "time | hdfs --codec=gzip" --deploy
xd:>stream destroy --name myhdfsstream4
xd:>hadoop fs ls /xd/myhdfsstream4
Found 1 items
-rw-r--r--  3 jvalkealahti supergroup      80 2013-12-18 18:48 /xd/myhdfsstream4/
myhdfsstream4-0.txt.gz
```

From a native os shell we can use hadoop's fs commands and pipe data into gunzip.

```
# bin/hadoop fs -cat /xd/myhdfsstream4/myhdfsstream4-0.txt.gz | gunzip
2013-12-18 18:48:10
2013-12-18 18:48:11
...
```

Often a stream of data may not have a high enough rate to roll over files frequently, leaving the file in an opened state. This prevents users from reading a consistent set of data when running mapreduce

jobs. While one can alleviate this problem by using a small rollover value, a better way is to use the `idleTimeout` option that will automatically close the file if there was no writes during the specified period of time. This feature is also useful in cases where burst of data is written into a stream and you'd like that data to become visible in HDFS.

Note

The `idleTimeout` value should not exceed the timeout values set on the Hadoop cluster. These are typically configured using the `dfs.socket.timeout` and/or `dfs.datanode.socket.write.timeout` properties in the `hdfs-site.xml` configuration file.

```
xd:> stream create --name myhdfsstream5 --definition "http --port=8000 | hdfs --rollover=20 --idleTimeout=10000" --deploy
```

In the above example we changed a source to `http` order to control what we write into a `hdfs` sink. We defined a small rollover size and a timeout of 10 seconds. Now we can simply post data into this stream via source end point using a below command.

```
xd:> http post --target http://localhost:8000 --data "hello"
```

If we repeat the command very quickly and then wait for the timeout we should be able to see that some files are closed before rollover size was met and some were simply rolled because of a rollover size.

```
xd:>hadoop fs ls /xd/myhdfsstream5
Found 4 items
-rw-r--r--  3 jvalkealahti supergroup      12 2013-12-18 19:02 /xd/myhdfsstream5/myhdfsstream5-0.txt
-rw-r--r--  3 jvalkealahti supergroup      24 2013-12-18 19:03 /xd/myhdfsstream5/myhdfsstream5-1.txt
-rw-r--r--  3 jvalkealahti supergroup      24 2013-12-18 19:03 /xd/myhdfsstream5/myhdfsstream5-2.txt
-rw-r--r--  3 jvalkealahti supergroup      18 2013-12-18 19:03 /xd/myhdfsstream5/myhdfsstream5-3.txt
```

Files can be automatically partitioned using a `partitionPath` expression. If we create a stream with `idleTimeout` and `partitionPath` with simple format `yyyy/MM/dd/HH/mm` we should see writes ending into its own files within every minute boundary.

```
xd:>stream create --name myhdfsstream6 --definition "time|hdfs --idleTimeout=10000 --partitionPath=dateFormat('yyyy/MM/dd/HH/mm')" --deploy
```

Let a stream run for a short period of time and list files.

```
xd:>hadoop fs ls --recursive true --dir /xd/myhdfsstream6
drwxr-xr-x  - jvalkealahti supergroup      0 2014-05-28 09:42 /xd/myhdfsstream6/2014
drwxr-xr-x  - jvalkealahti supergroup      0 2014-05-28 09:42 /xd/myhdfsstream6/2014/05
drwxr-xr-x  - jvalkealahti supergroup      0 2014-05-28 09:42 /xd/myhdfsstream6/2014/05/28
drwxr-xr-x  - jvalkealahti supergroup      0 2014-05-28 09:45 /xd/myhdfsstream6/2014/05/28/09
drwxr-xr-x  - jvalkealahti supergroup      0 2014-05-28 09:43 /xd/myhdfsstream6/2014/05/28/09/42
-rw-r--r--  3 jvalkealahti supergroup      140 2014-05-28 09:43 /xd/myhdfsstream6/2014/05/28/09/42/
myhdfsstream6-0.txt
drwxr-xr-x  - jvalkealahti supergroup      0 2014-05-28 09:44 /xd/myhdfsstream6/2014/05/28/09/43
-rw-r--r--  3 jvalkealahti supergroup     1200 2014-05-28 09:44 /xd/myhdfsstream6/2014/05/28/09/43/
myhdfsstream6-0.txt
drwxr-xr-x  - jvalkealahti supergroup      0 2014-05-28 09:45 /xd/myhdfsstream6/2014/05/28/09/44
-rw-r--r--  3 jvalkealahti supergroup     1200 2014-05-28 09:45 /xd/myhdfsstream6/2014/05/28/09/44/
myhdfsstream6-0.txt
```

Partitioning can also be based on defined lists. In a below example we simulate feeding data by using a `time` and a `transform` elements. Data passed to `hdfs` sink has a content `APP0:foobar`, `APP1:foobar`, `APP2:foobar` or `APP3:foobar`.

```
xd:>stream create --name myhdfsstream7 --definition "time | transform --expression=
\'APP'+T(Math).round(T(Math).random()*3)+'foobar\'\" | hdfs --idleTimeout=10000 --
partitionPath=path(dateFormat('yyyy/MM/dd/HH'),list(payload.split(':')[0],{{'0T01','APP0','APP1'},
{'2T03','APP2','APP3'}}))" --deploy
```

Let the stream run few seconds, destroy it and check what got written in those partitioned files.

```
xd:>stream destroy --name myhdfsstream7
Destroyed stream 'myhdfsstream7'
xd:>hadoop fs ls --recursive true --dir /xd
drwxr-xr-x - jvalkealahti supergroup      0 2014-05-28 19:24 /xd/myhdfsstream7
drwxr-xr-x - jvalkealahti supergroup      0 2014-05-28 19:24 /xd/myhdfsstream7/2014
drwxr-xr-x - jvalkealahti supergroup      0 2014-05-28 19:24 /xd/myhdfsstream7/2014/05
drwxr-xr-x - jvalkealahti supergroup      0 2014-05-28 19:24 /xd/myhdfsstream7/2014/05/28
drwxr-xr-x - jvalkealahti supergroup      0 2014-05-28 19:24 /xd/myhdfsstream7/2014/05/28/19
drwxr-xr-x - jvalkealahti supergroup      0 2014-05-28 19:24 /xd/
myhdfsstream7/2014/05/28/19/0T01_list
-rw-r--r--  3 jvalkealahti supergroup      108 2014-05-28 19:24 /xd/
myhdfsstream7/2014/05/28/19/0T01_list/myhdfsstream7-0.txt
drwxr-xr-x - jvalkealahti supergroup      0 2014-05-28 19:24 /xd/
myhdfsstream7/2014/05/28/19/2T03_list
-rw-r--r--  3 jvalkealahti supergroup      180 2014-05-28 19:24 /xd/
myhdfsstream7/2014/05/28/19/2T03_list/myhdfsstream7-0.txt
xd:>hadoop fs cat /xd/myhdfsstream7/2014/05/28/19/0T01_list/myhdfsstream7-0.txt
APP1:foobar
APP1:foobar
APP0:foobar
APP0:foobar
APP1:foobar
```

Partitioning can also be based on defined ranges. In a below example we simulate feeding data by using a time and a transform elements. Data passed to hdfs sink has a content ranging from APP0 to APP15. We simple parse the number part and use it to do a partition with ranges {3,5,10}.

```
xd:>stream create --name myhdfsstream8 --definition "time | transform --expression=
\'APP'+T(Math).round(T(Math).random()*15)\'\" | hdfs --idleTimeout=10000 --
partitionPath=path(dateFormat('yyyy/MM/dd/HH'),range(T(Integer).parseInt(payload.substring(3)),
{3,5,10}))" --deploy
```

Let the stream run few seconds, destroy it and check what got written in those partitioned files.

```

xd:>stream destroy --name myhdfsstream8
Destroyed stream 'myhdfsstream8'
xd:>hadoop fs ls --recursive true --dir /xd
drwxr-xr-x - jvalkealahti supergroup          0 2014-05-28 19:34 /xd/myhdfsstream8
drwxr-xr-x - jvalkealahti supergroup          0 2014-05-28 19:34 /xd/myhdfsstream8/2014
drwxr-xr-x - jvalkealahti supergroup          0 2014-05-28 19:34 /xd/myhdfsstream8/2014/05
drwxr-xr-x - jvalkealahti supergroup          0 2014-05-28 19:34 /xd/myhdfsstream8/2014/05/28
drwxr-xr-x - jvalkealahti supergroup          0 2014-05-28 19:34 /xd/myhdfsstream8/2014/05/28/19
drwxr-xr-x - jvalkealahti supergroup          0 2014-05-28 19:34 /xd/
myhdfsstream8/2014/05/28/19/10_range
-rw-r--r--  3 jvalkealahti supergroup          16 2014-05-28 19:34 /xd/
myhdfsstream8/2014/05/28/19/10_range/myhdfsstream8-0.txt
drwxr-xr-x - jvalkealahti supergroup          0 2014-05-28 19:34 /xd/
myhdfsstream8/2014/05/28/19/3_range
-rw-r--r--  3 jvalkealahti supergroup          35 2014-05-28 19:34 /xd/
myhdfsstream8/2014/05/28/19/3_range/myhdfsstream8-0.txt
drwxr-xr-x - jvalkealahti supergroup          0 2014-05-28 19:34 /xd/
myhdfsstream8/2014/05/28/19/5_range
-rw-r--r--  3 jvalkealahti supergroup          5 2014-05-28 19:34 /xd/
myhdfsstream8/2014/05/28/19/5_range/myhdfsstream8-0.txt
xd:>hadoop fs cat /xd/myhdfsstream8/2014/05/28/19/3_range/myhdfsstream8-0.txt
APP3
APP3
APP1
APP0
APP1
xd:>hadoop fs cat /xd/myhdfsstream8/2014/05/28/19/5_range/myhdfsstream8-0.txt
APP4
xd:>hadoop fs cat /xd/myhdfsstream8/2014/05/28/19/10_range/myhdfsstream8-0.txt
APP6
APP15
APP7

```

Partition using a `dateFormat` can be based on content itself. This is a good use case if old log files needs to be processed where partitioning should happen based on timestamp of a log entry. We create a fake log data with a simple date string ranging from 1970-01-10 to 1970-01-13.

```

xd:>stream create --name myhdfsstream9 --definition "time | transform --expression=
\'1970-01-\' + 1 + T(Math).round(T(Math).random()*3)\' | hdfs --idleTimeout=10000 --
partitionPath=path(dateFormat(\'yyyy/MM/dd/HH\',payload,\'yyyy-MM-DD\'))" --deploy

```

Let the stream run few seconds, destroy it and check what got written in those partitioned files. If you see the partition paths, those are based on year 1970, not present year.

```

xd:>stream destroy --name myhdfsstream9
Destroyed stream 'myhdfsstream9'
xd:>hadoop fs ls --recursive true --dir /xd
drwxr-xr-x - jvalkealahti supergroup          0 2014-05-28 19:56 /xd/myhdfsstream9
drwxr-xr-x - jvalkealahti supergroup          0 2014-05-28 19:56 /xd/myhdfsstream9/1970
drwxr-xr-x - jvalkealahti supergroup          0 2014-05-28 19:56 /xd/myhdfsstream9/1970/01
drwxr-xr-x - jvalkealahti supergroup          0 2014-05-28 19:56 /xd/myhdfsstream9/1970/01/10
drwxr-xr-x - jvalkealahti supergroup          0 2014-05-28 19:57 /xd/myhdfsstream9/1970/01/10/00
-rw-r--r--  3 jvalkealahti supergroup        44 2014-05-28 19:57 /xd/myhdfsstream9/1970/01/10/00/
myhdfsstream9-0.txt
drwxr-xr-x - jvalkealahti supergroup          0 2014-05-28 19:56 /xd/myhdfsstream9/1970/01/11
drwxr-xr-x - jvalkealahti supergroup          0 2014-05-28 19:57 /xd/myhdfsstream9/1970/01/11/00
-rw-r--r--  3 jvalkealahti supergroup        99 2014-05-28 19:57 /xd/myhdfsstream9/1970/01/11/00/
myhdfsstream9-0.txt
drwxr-xr-x - jvalkealahti supergroup          0 2014-05-28 19:56 /xd/myhdfsstream9/1970/01/12
drwxr-xr-x - jvalkealahti supergroup          0 2014-05-28 19:57 /xd/myhdfsstream9/1970/01/12/00
-rw-r--r--  3 jvalkealahti supergroup        44 2014-05-28 19:57 /xd/myhdfsstream9/1970/01/12/00/
myhdfsstream9-0.txt
drwxr-xr-x - jvalkealahti supergroup          0 2014-05-28 19:56 /xd/myhdfsstream9/1970/01/13
drwxr-xr-x - jvalkealahti supergroup          0 2014-05-28 19:57 /xd/myhdfsstream9/1970/01/13/00
-rw-r--r--  3 jvalkealahti supergroup        55 2014-05-28 19:57 /xd/myhdfsstream9/1970/01/13/00/
myhdfsstream9-0.txt
xd:>hadoop fs cat /xd/myhdfsstream9/1970/01/10/00/myhdfsstream9-0.txt
1970-01-10
1970-01-10
1970-01-10
1970-01-10

```

HDFS with Options

The **hdfs** sink has the following options:

codec

compression codec alias name (gzip, snappy, bzip2, lzo, or slzo) **(String, default: ``)**

directory

where to output the files in the Hadoop FileSystem **(String, default: /xd/<stream name>)**

fileExtension

the base filename extension to use for the created files **(String, default: txt)**

fileName

the base filename to use for the created files **(String, default: <stream name>)**

fileOpenAttempts

maximum number of file open attempts to find a path **(int, default: 10)**

fileUuid

whether file name should contain uuid **(boolean, default: false)**

fsUri

the URI to use to access the Hadoop FileSystem **(String, default: \${spring.hadoop.fsUri})**

idleTimeout

inactivity timeout after file will be automatically closed **(long, default: 0)**

inUsePrefix

prefix for files currently being written **(String, default: ``)**

inUseSuffix

suffix for files currently being written **(String, default: .tmp)**

overwrite

whether writer is allowed to overwrite files in Hadoop FileSystem (**boolean, default: false**)

partitionPath

a SpEL expression defining the partition path (**String, default: ``**)

rollover

threshold in bytes when file will be automatically rolled over (**String, default: 1G**)

Note

In the context of the `fileOpenAttempts` option, attempt is either one rollover request or failed stream open request for a path (if another writer came up with a same path and already opened it).

Partition Path Expression

SpEL expression is evaluated against a Spring Messaging `Message` passed internally into a HDFS writer. This allows expression to use `headers` and `payload` from that message. While you could do a custom processing within a stream and add custom headers, `timestamp` is always going to be there. Data to be written is then available in a `payload`.

Accessing Properties

Using a `payload` simply returns whatever is currently being written. Access to headers is via `headers` property. Any other property is automatically resolved from headers if found. For example `headers.timestamp` is equivalent to `timestamp`.

Custom Methods

In addition to a normal SpEL functionality, few custom methods have been added to make it easier to build partition paths. These custom methods can be used to work with a normal partition concepts like date formatting, lists, ranges and hashes.

path

```
path(String... paths)
```

Concatenates paths together with a delimiter `/`. This method can be used to make the expression less verbose than using a native SpEL functionality to combine path parts together. To create a path `part1/part2`, expression `'part1' + '/' + 'part2'` is equivalent to `path('part1', 'part2')`.

Parameters

paths

Any number of path parts

Return Value. Concatenated value of paths delimited with `/`.

dateFormat

```
dateFormat(String pattern)
dateFormat(String pattern, Long epoch)
dateFormat(String pattern, Date date)
dateFormat(String pattern, String datestring)
dateFormat(String pattern, String datestring, String dateFormat)
```

Creates a path using date formatting. Internally this method delegates into `SimpleDateFormat` and needs a `Date` and a `pattern`. On default if no parameter used for conversion is given, `timestamp`

is expected. Effectively `dateFormat('yyyy')` equals to `dateFormat('yyyy', timestamp)` or `dateFormat('yyyy', headers.timestamp)`.

Method signature with three parameters can be used to create a custom `Date` object which is then passed to `SimpleDateFormat` conversion using a `dateFormat` pattern. This is useful in use cases where partition should be based on a date or time string found from a payload content itself. Default `dateFormat` pattern if omitted is `yyyy-MM-dd`.

Parameters

pattern

Pattern compatible with `SimpleDateFormat` to produce a final output.

epoch

Timestamp as `Long` which is converted into a `Date`.

date

A `Date` to be formatted.

dateFormat

Secondary pattern to convert `datestring` into a `Date`.

datestring

Date as a `String`

Return Value. A path part representation which can be a simple file or directory name or a directory structure.

list

```
list(Object source, List<List<Object>> lists)
```

Creates a partition path part by matching a `source` against a `lists` denoted by `lists`.

Lets assume that data is being written and it's possible to extract an `appid` either from headers or payload. We can automatically do a list based partition by using a partition method `list(headers.appid, {'1TO3', 'APP1', 'APP2', 'APP3'}, {'4TO6', 'APP4', 'APP5', 'APP6'})`. This method would create three partitions, `1TO3_list`, `4TO6_list` and `list`. Latter is used if no match is found from partition lists passed to `lists`.

Parameters

source

An `Object` to be matched against `lists`.

lists

A definition of list of lists.

Return Value. A path part prefixed with a matched key i.e. `XXX_list` or `list` if no match.

range

```
range(Object source, List<Object> list)
```

Creates a partition path part by matching a `source` against a `list` denoted by `list` using a simple binary search.

The partition method takes a `source` as first argument and `list` as a second argument. Behind the scenes this is using `jvm's binarySearch` which works on an `Object` level so we can pass in anything.

Remember that meaningful range match only works if passed in `Object` and types in list are of same type like `Integer`. Range is defined by a `BinarySearch` itself so mostly it is to match against an upper bound except the last range in a list. Having a list of `{1000, 3000, 5000}` means that everything above 3000 will be matched with 5000. If that is an issue then simply adding `Integer.MAX_VALUE` as last range would overflow everything above 5000 into a new partition. Created partitions would then be `1000_range`, `3000_range` and `5000_range`.

Parameters

source

An `Object` to be matched against `list`.

list

A definition of `list`.

Return Value. A path part prefixed with a matched key i.e. `XXX_range`.

hash

```
hash(Object source, int bucketcount)
```

Creates a partition path part by calculating hashkey using `source`'s `hashCode` and `bucketcount`. Using a partition method `hash(timestamp, 2)` would then create partitions named `0_hash`, `1_hash` and `2_hash`. Number suffixed with `_hash` is simply calculated using `Object.hashCode() % bucketcount`.

Parameters

source

An `Object` which `hashCode` will be used.

bucketcount

A number of buckets

Return Value. A path part prefixed with a hash key i.e. `XXX_hash`.

14.5 HDFS Dataset (Avro/Parquet)

The HDFS Dataset sink is used to store Java classes that are sent as the payload on the stream. It uses the [Kite SDK Data Module](#)'s Dataset implementation to store the payload data serialized in either Avro or Parquet format. The Avro schema is generated from the Java class that is persisted. For Parquet the Java object must follow JavaBean conventions with properties for any fields to be persisted. The fields can only be simple scalar values like Strings and numbers.

The HDFS Dataset sink requires that you have a Hadoop installation that is based on Hadoop v2 (Hadoop 2.2.0, Pivotal HD 1.0, Cloudera CDH4 or Hortonworks HDP 2.0), see [using Hadoop](#) for more information on how to start Spring XD to target a specific distribution.

Once Hadoop is up and running, you can then use the `hdfs-dataset` sink when creating a [stream](#)

```
xd:>stream create --name mydataset --definition "time | hdfs-dataset --batchSize=20" --deploy
```

In the above example, we've scheduled `time` source to automatically send ticks to the `hdfs-dataset` sink once every second. The data will be stored in a directory named `/xd/<streamname>` by default, so in this example it will be `/xd/mydataset`. You can change this by supplying a `--basePath` parameter and/or `--namespace` parameter. The `--basePath` defaults to `/xd` and the `--namespace` defaults

to `<streamname>`. The Avro format is used by default and the data files are stored in a sub-directory named after the payload Java class. In this example the stream payload is a `String` so the name of the data sub-directory is `string`. If you have multiple Java classes as payloads, each class will get its own sub-directory.

Let the stream run for a minute or so. You can then list the contents of the hadoop filesystem using the shell's built in `hadoop fs` commands. You will first need to configure the shell to point to your name node using the `hadoop config` command. We use the `hdfs` protocol to access the hadoop name node.

```
xd:>hadoop config fs --namenode hdfs://localhost:8020
```

Then list the contents of the stream's data directory.

```
xd:>hadoop fs ls /xd/mydataset/string
Found 3 items
drwxr-xr-x  - trisberg supergroup          0 2013-12-19 12:23 /xd/mydataset/string/.metadata
-rw-r--r--  3 trisberg supergroup        202 2013-12-19 12:23 /xd/mydataset/
string/1387473825754-63.avro
-rw-r--r--  3 trisberg supergroup        216 2013-12-19 12:24 /xd/mydataset/
string/1387473846708-80.avro
```

You can see that the sink has created two files containing the first two batches of 20 stream payloads each. There is also a `.metadata` directory created that contains the metadata that the Kite SDK Dataset implementation uses as well as the generated Avro schema for the persisted type.

```
xd:>hadoop fs ls /xd/mydataset/string/.metadata
Found 2 items
-rw-r--r--  3 trisberg supergroup        136 2013-12-19 12:23 /xd/mydataset/string/.metadata/
descriptor.properties
-rw-r--r--  3 trisberg supergroup         8 2013-12-19 12:23 /xd/mydataset/string/.metadata/
schema.avsc
```

Now destroy the stream.

```
xd:>stream destroy --name mydataset
```

HDFS Dataset with Options

The `hdfs-dataset` sink has the following options:

allowNullValues

whether null property values are allowed, if set to true then schema will use UNION for each field
(**boolean, default: false**)

basePath

the base directory path where the files will be written in the Hadoop FileSystem (**String, default: /xd**)

batchSize

threshold in number of messages when file will be automatically flushed and rolled over (**long, default: 10000**)

compressionType

compression type name (snappy, deflate, bzip2 (avro only) or uncompressed) (**String, default: snappy**)

format

the format to use, valid options are avro and parquet (**String, default: avro**)

fsUri

the URI to use to access the Hadoop FileSystem (**String, default: `${spring.hadoop.fsUri}`**)

idleTimeout

idle timeout in milliseconds when Hadoop file resource is automatically closed (**long, default: -1**)

namespace

the sub-directory under the basePath where files will be written (**String, default: `<stream name>`**)

partitionPath

the partition path strategy to use, a list of KiteSDK partition expressions separated by a '/' symbol (**String, default: ``**)

writerCacheSize

the size of the cache to be used for partition writers (10 if omitted) (**int, default: -1**)

About null values

If `allowNullValues` is set to true then each field in the generated schema will use a union of *null* and the data type of the field. You can also set `allowNullValues` to false and instead annotate fields in a POJO using Avro's `org.apache.avro.reflect.Nullable` annotation to create a schema using a union with *null* for that annotated field.

About partitionPath

The `partitionPath` option lets you specify one or more paths that will be used to partition the files that the data is written to based on the content of the data. You can use any of the [FieldPartitioners](#) that are available for the Kite SDK project. We simply pass in what is specified to create the corresponding partition strategy. You can separate multiple paths with a / character. The following partitioning functions are available:

- *year, month, day, hour, minute* creates partitions based on the value of a timestamp and creates directories named like "YEAR=2014" (works well with fields of datatype long)
 - specify function plus field name like: `year('timestamp')`
- *dateformat* creates partitions based on a timestamp and a dateformat expression provided - creates directories based on the name provided (works well with fields of datatype long)
 - specify function plus field name, a name for the partition and the date format like: `dateFormat('timestamp', 'Y-M', 'yyyyMM')`
- *range* creates partitions based on a field value and the upper bounds for each bucket that is specified (works well with fields of datatype int and string)
 - specify function plus field name and the upper bounds for each partition bucket like: `range('age', 20, 50, 80, T(Integer).MAX_VALUE)` (Note that you can use SpEL expressions like we just did for the `Integer.MAX_VALUE`)
- *identity* creates partitions based on the exact value of a field (works well with fields of datatype string, long and int)
 - specify function plus field name, a name for the partition, the type of the field (String or Integer) and the number of values/buckets for the partition like: `identity('region', 'R', T(String), 10)`

- *hash* creates partitions based on the hash calculated from the value of a field divided into a number of buckets that is specified (works well with all data types)
 - specify function plus field name and number of buckets like: `hash('lastname',10)`

Multiple expressions can be specified by separating them with a `/` like: `identity('region','R',T(String),10)/year('timestamp')/month('timestamp')`

14.6 JDBC

The JDBC sink can be used to insert message payload data into a relational database table. By default it inserts the entire payload into a table named after the stream name in the HSQLDB database that XD uses to store metadata for batch jobs. To alter this behavior, the `jdbc` sink accepts several options that you can pass using the `--foo=bar` notation in the stream, or [change globally](#). There is also a `config/init_db.sql` file that contains the SQL statements used to initialize the database table. You can modify this file if you'd like to create a table with your specific layout when the sink starts. You should also change the `initializeDatabase` property to `true` to have this script execute when the sink starts up.

The payload data will be inserted as-is if the `names` option is set to `payload`. This is the default behavior. If you specify any other column names the payload data will be assumed to be a JSON document that will be converted to a hash map. This hash map will be used to populate the data values for the SQL insert statement. A matching of column names with underscores like `user_name` will match onto camel case style keys like `userName` in the hash map. There will be one insert statement executed for each message.

To create a stream using a `jdbc` sink relying on all defaults you would use a command like

```
xd:> stream create --name mydata --definition "time | jdbc --initializeDatabase=true" --deploy
```

This will insert the time messages into a `payload` column in a table named `mydata`. Since the default is using the XD batch metadata HSQLDB database we can connect to this database instance from an external tool. After we let the stream run for a little while, we can connect to the database and look at the data stored in the database.

You can query the database with your favorite SQL tool using the following database URL: `jdbc:hsqldb:hsqldb://localhost:9101/xdjob` with `sa` as the user name and a blank password. You can also use the HSQL provided SQL Tool (download from [HSQLDB](#)) to run a quick query from the command line:

```
$ java -cp ~/Downloads/hsqldb-2.3.0/hsqldb/lib/sqltool.jar org.hsqldb.cmdline.SqlTool --inlineRc url=jdbc:hsqldb:hsqldb://localhost:9101/xdjob,user=sa,password= --sql "select payload from mydata;"
```

This should result in something similar to the following output:

```
2014-01-06 09:33:25
2014-01-06 09:33:26
2014-01-06 09:33:27
2014-01-06 09:33:28
2014-01-06 09:33:29
2014-01-06 09:33:30
2014-01-06 09:33:31
2014-01-06 09:33:32
2014-01-06 09:33:33
2014-01-06 09:33:34
2014-01-06 09:33:35
2014-01-06 09:33:36
2014-01-06 09:33:37
```

Now we can destroy the stream using:

```
xd:> stream destroy --name mydata
```

JDBC with Options

The **jdbc** sink has the following options:

abandonWhenPercentageFull

connections that have timed out wont get closed and reported up unless the number of connections in use are above the percentage (**int, default: 0**)

alternateUsernameAllowed

uses an alternate user name if connection fails (**boolean, default: false**)

columns

the database columns to map the data to (**String, default: payload**)

connectionProperties

connection properties that will be sent to our JDBC driver when establishing new connections (**String, no default**)

driverClassName

the JDBC driver to use (**String, no default**)

fairQueue

set to true if you wish that calls to getConnection should be treated fairly in a true FIFO fashion (**boolean, default: true**)

initSQL

custom query to be run when a connection is first created (**String, no default**)

initialSize

initial number of connections that are created when the pool is started (**int, default: 0**)

initializeDatabase

whether the database initialization script should be run (**boolean, default: false**)

initializerScript

the name of the SQL script (in /config) to run if 'initializeDatabase' is set (**String, default: init_db.sql**)

jdbcInterceptors

semicolon separated list of classnames extending org.apache.tomcat.jdbc.pool.JdbcInterceptor (**String, no default**)

jmxEnabled

register the pool with JMX or not (**boolean, default: true**)

logAbandoned

flag to log stack traces for application code which abandoned a Connection (**boolean, default: false**)

maxActive

maximum number of active connections that can be allocated from this pool at the same time (**int, default: 100**)

maxAge
time in milliseconds to keep this connection (**int, default: 0**)

maxIdle
maximum number of connections that should be kept in the pool at all times (**int, default: 100**)

maxWait
maximum number of milliseconds that the pool will wait for a connection (**int, default: 30000**)

minEvictableIdleTimeMillis
minimum amount of time an object may sit idle in the pool before it is eligible for eviction (**int, default: 60000**)

minIdle
minimum number of established connections that should be kept in the pool at all times (**int, default: 10**)

password
the JDBC password (**Password, no default**)

removeAbandoned
flag to remove abandoned connections if they exceed the `removeAbandonedTimeout` (**boolean, default: false**)

removeAbandonedTimeout
timeout in seconds before an abandoned connection can be removed (**int, default: 60**)

suspectTimeout
this simply logs the warning after timeout, connection remains (**int, default: 0**)

tableName
the database table to which the data will be written (**String, default: <stream name>**)

testOnBorrow
indication of whether objects will be validated before being borrowed from the pool (**boolean, default: false**)

testOnReturn
indication of whether objects will be validated before being returned to the pool (**boolean, default: false**)

testWhileIdle
indication of whether objects will be validated by the idle object evictor (**boolean, default: false**)

timeBetweenEvictionRunsMillis
number of milliseconds to sleep between runs of the idle connection validation/cleaner thread (**int, default: 5000**)

url
the JDBC URL for the database (**String, no default**)

useEquals
true if you wish the `ProxyConnection` class to use `String.equals` (**boolean, default: true**)

username
the JDBC username (**String, no default**)

validationInterval

avoid excess validation, only run validation at most at this frequency - time in milliseconds (**long**, **default: 30000**)

validationQuery

sql query that will be used to validate connections from this pool (**String**, **no default**)

validatorClassName

name of a class which implements the org.apache.tomcat.jdbc.pool.Validator (**String**, **no default**)

Note

To include the whole message into a single column, use `payload` (the default) for the `columns` option

Tip

The connection pool settings for xd are located in `servers.yml` (i.e. `spring.datasource.*`)

14.7 TCP Sink

The TCP Sink provides for outbound messaging over TCP.

The following examples use `netcat` (linux) to receive the data; the equivalent on Mac OSX is `nc`.

First, start a netcat to receive the data, and background it

```
$ netcat -l 1234 &
```

Now, configure a stream

```
xd:> stream create --name tcptest --definition "time --fixedDelay=3 | tcp" --deploy
```

This sends the time, every 3 seconds to the default tcp Sink, which connects to port 1234 on localhost.

```
$ Thu May 30 10:28:21 EDT 2013
Thu May 30 10:28:24 EDT 2013
Thu May 30 10:28:27 EDT 2013
Thu May 30 10:28:30 EDT 2013
Thu May 30 10:28:33 EDT 2013
```

TCP is a streaming protocol and some mechanism is needed to frame messages on the wire. A number of encoders are available, the default being *CRLF*.

Destroy the stream; netcat will terminate when the TCP Sink disconnects.

```
http://localhost:8080> stream destroy --name tcptest
```

TCP with Options

The **tcp** sink has the following options:

bufferSize

the size of the buffer (bytes) to use when encoding/decoding (**int**, **default: 2048**)

charset

the charset used when converting from String to bytes (**String, default: UTF-8**)

close

whether to close the socket after each message (**boolean, default: false**)

encoder

the encoder to use when sending messages (**Encoding, default: CRLF, possible values: CRLF, LF, NULL, STXETX, RAW, L1, L2, L4**)

host

the remote host to connect to (**String, default: localhost**)

nio

whether or not to use NIO (**boolean, default: false**)

port

the port on the remote host to connect to (**int, default: 1234**)

reverseLookup

perform a reverse DNS lookup on the remote IP Address (**boolean, default: false**)

socketTimeout

the timeout (ms) before closing the socket when no data is received (**int, default: 120000**)

useDirectBuffers

whether or not to use direct buffers (**boolean, default: false**)

Note

With the default retry configuration, the attempts will be made after 0, 2, 4, 8, and 16 seconds.

Available Encoders

*Text Data***CRLF (default)**

text terminated by carriage return (0x0d) followed by line feed (0x0a)

LF

text terminated by line feed (0x0a)

NULL

text terminated by a null byte (0x00)

STXETX

text preceded by an STX (0x02) and terminated by an ETX (0x03)

*Text and Binary Data***RAW**

no structure - the client indicates a complete message by closing the socket

L1

data preceded by a one byte (unsigned) length field (supports up to 255 bytes)

L2

data preceded by a two byte (unsigned) length field (up to $2^{16}-1$ bytes)

L4

data preceded by a four byte (signed) length field (up to $2^{31}-1$ bytes)

An Additional Example

Start netcat in the background and redirect the output to a file `foo`

```
$ netcat -l 1235 > foo &
```

Create the stream, using the L4 encoder

```
xd:> stream create --name tcpctest --definition "time --interval=3 | tcp --encoder=L4 --port=1235" --
deploy
```

Destroy the stream

```
http://localhost:8080> stream destroy --name tcpctest
```

Check the output

```
$ hexdump -C foo
00000000 00 00 00 1c 54 68 75 20 4d 61 79 20 33 30 20 31 |...Thu May 30 1|
00000010 30 3a 34 37 3a 30 33 20 45 44 54 20 32 30 31 33 |0:47:03 EDT 2013|
00000020 00 00 00 1c 54 68 75 20 4d 61 79 20 33 30 20 31 |...Thu May 30 1|
00000030 30 3a 34 37 3a 30 36 20 45 44 54 20 32 30 31 33 |0:47:06 EDT 2013|
00000040 00 00 00 1c 54 68 75 20 4d 61 79 20 33 30 20 31 |...Thu May 30 1|
00000050 30 3a 34 37 3a 30 39 20 45 44 54 20 32 30 31 33 |0:47:09 EDT 2013|
```

Note the 4 byte length field preceding the data generated by the L4 encoder.

14.8 Shell Sink

The `shell` sink forks an external process by running a shell command to launch a process written in any language. The process should implement a continual loop that waits for and consumes input from `stdin`. The process will be destroyed when the stream is undeployed. For example, it is possible to invoke a Python script within a stream in this manner. Since the shell sink relies on low-level stream processing there are some additional requirements:

- Input data is expected to be a `String`, the `charset` is configurable.
- Anything written to `stderr` will be logged as an `ERROR` in Spring XD but will not terminate the stream.
- All messages must be terminated using the configured encoder (CRLF or `"\r\n"` is the default) for the module and must not exceed the configured `bufferSize` (see the detailed description of encoders in the [TCP](#) section).
- Any external software required to run the script must be installed on the container node to which the module is deployed.

Here is a simple template for a Python script that consumes input:

```
#sink.py
import sys

while True:
    try:
        data = raw_input()
        if data:
            #insert a function call here, data is a string.
    except EOFError:
        break
```

Note

Spring XD provides additional Python programming support for handling basic stream processing, as shown above, see [creating a Python module](#).

The **shell** sink has the following options:

bufferSize

the size of the buffer (bytes) to use when encoding/decoding (**int, default: 2048**)

charset

the charset used when converting from String to bytes (**String, default: UTF-8**)

command

the shell command (**String, no default**)

encoder

the encoder to use when sending messages (**Encoding, default: CRLF, possible values: CRLF, LF, NULL, STXETX, RAW, L1, L2, L4**)

environment

additional process environment variables as comma delimited name-value pairs (**String, no default**)

redirectErrorStream

redirects stderr to stdout (**boolean, default: false**)

workingDir

the process working directory (**String, no default**)

14.9 Mongo

The Mongo sink writes into a Mongo collection. Here is a simple example

```
xd:>stream create --name attendees --definition "http | mongodb --databaseName=test --
collectionName=names" --deploy
```

Then,

```
xd:>http post --data {"firstName":"mark"}
```

In the mongo console you will see the document stored

```
> use test
switched to db test
> show collections
names
system.indexes
> db.names.find()
{ "_id" : ObjectId("53c93bc324ac76925a77b9df"), "firstName" : "mark" }
```

The **mongodb** sink has the following options:

authenticationDatabaseName

the MongoDB authentication database used for connecting (**String, default: ``**)

collectionName

the MongoDB collection to store (**String, default: <stream name>**)

databaseName

the MongoDB database name (**String, default: xd**)

host

the MongoDB host to connect to (**String, default: localhost**)

password

the MongoDB password used for connecting (**String, default: ``**)

port

the MongoDB port to connect to (**int, default: 27017**)

username

the MongoDB username used for connecting (**String, default: ``**)

writeConcern

the default MongoDB write concern to use (**WriteConcern, default: SAFE, possible values: NONE, NORMAL, SAFE, FSYNC_SAFE, REPLICAS_SAFE, JOURNAL_SAFE, MAJORITY**)

14.10 Mail

The "mail" sink allows sending of messages as emails, leveraging Spring Integration mail-sending channel adapter. Please refer to Spring Integration documentation for the details, but in a nutshell, the sink is able to handle String, byte[] and MimeMessage messages out of the box.

Here is a simple example of how the mail module is used:

```
xd:> stream create mystream --definition "http | mail --to='\"your.email@gmail.com\"' --
host=your.imap.server --subject=payload+' world'" --deploy
```

Then,

```
xd:> http post --data Hello
```

You would then receive an email whose body contains "Hello" and whose subject is "Hellow world". Of special attention here is the way you need to escape strings for most of the parameters, because they're actually SpEL expressions (so here for example, we used a String literal for the `to` parameter).

The **mail** sink has the following options:

bcc

the recipient(s) that should receive a blind carbon copy (SpEL) (**String, default: null**)

cc

the recipient(s) that should receive a carbon copy (SpEL) (**String, default: null**)

contentType

the content type to use when sending the email (SpEL) (**String, default: null**)

from

the primary recipient(s) of the email (SpEL) (**String, default: null**)

host

the hostname of the mail server (**String, default: localhost**)

password

the password to use to connect to the mail server (**String, no default**)

port

the port of the mail server (**int, default: 25**)

replyTo

the address that will become the recipient if the original recipient decides to "reply to" the email (SpEL) (**String, default: null**)

subject

the email subject (SpEL) (**String, default: null**)

to

the primary recipient(s) of the email (SpEL) (**String, default: null**)

username

the username to use to connect to the mail server (**String, no default**)

14.11 RabbitMQ

The "rabbit" sink enables outbound messaging over RabbitMQ.

The following example shows the default settings.

Configure a stream:

```
xd:> stream create --name rabbittest --definition "time --interval=3 | rabbit" --deploy
```

This sends the time, every 3 seconds to the default (no-name) Exchange for a RabbitMQ broker running on localhost, port 5672.

The routing key will be the name of the stream by default; in this case: "rabbittest". Since the default Exchange is a direct-exchange to which all Queues are bound with the Queue name as the binding key, all messages sent via this sink will be passed to a Queue named "rabbittest", if one exists. We do not create that Queue automatically. However, you can easily create a Queue using the RabbitMQ web UI. Then, using that same UI, you can navigate to the "rabbittest" Queue and click the "Get Message(s)" button to pop messages off of that Queue (you can choose whether to requeue those messages).

To destroy the stream, enter the following at the shell prompt:

```
xd:> stream destroy --name rabbittest
```

RabbitMQ with Options

The **rabbit** sink has the following options:

addresses

a comma separated list of 'host[:port]' addresses (**String, default: `${spring.rabbitmq.addresses}`**)

converterClass
the class name of the message converter (**String, default: `org.springframework.amqp.support.converter.SimpleMessageConverter`**)

deliveryMode
the delivery mode (PERSISTENT, NON_PERSISTENT) (**String, default: PERSISTENT**)

exchange
the Exchange on the RabbitMQ broker to which messages should be sent (**String, default: ``**)

mappedRequestHeaders
request message header names to be propagated to/from the adapter/gateway (**String, default: `STANDARD_REQUEST_HEADERS`**)

password
the password to use to connect to the broker (**String, default: `${spring.rabbitmq.password}`**)

routingKey
the routing key to be passed with the message, as a SpEL expression (**String, default: `'<stream name>'`**)

sslPropertiesLocation
resource containing SSL properties (**String, default: `${spring.rabbitmq.sslProperties}`**)

useSSL
true if SSL should be used for the connection (**String, default: `${spring.rabbitmq.useSSL}`**)

username
the username to use to connect to the broker (**String, default: `${spring.rabbitmq.username}`**)

vhost
the RabbitMQ virtual host to use (**String, default: `${spring.rabbitmq.virtual_host}`**)

Note

Please be aware that the `routingKey` option is actually a SpEL expression. Hence if a simple, constant, string literal is to be used, make sure to use something like this:

```
xd:> stream create rabbitSinkStream --definition "http | rabbit --routingKey='\\"myqueue\\"'" --
deploy
```

See the [RabbitMQ MessageBus Documentation](#) for more information about SSL configuration.

14.12 GemFire Server

Currently XD supports GemFire's client-server topology. A sink that writes data to a GemFire cache requires at least one cache server to be running in a separate process and may also be configured to use a Locator. While Gemfire configuration is outside of the scope of this document, details are covered in the [GemFire Product documentation](#). The XD distribution includes a standalone GemFire server executable suitable for development and test purposes and bootstrapped using a Spring configuration file provided as a command line argument. The GemFire jar is distributed freely under GemFire's development license and is subject to the license's terms and conditions. Sink modules provided with

the XD distribution that write data to GemFire create a client cache and client region. No data is cached on the client.

Launching the XD GemFire Server

To start the GemFire cache server GemFire Server included in the Spring XD distribution, go to the XD install directory:

```
$cd gemfire/bin
$./gemfire-server ../config/cq-demo.xml
```

The command line argument is the path of a Spring Data Gemfire configuration file with including a configured cache server and one or more regions. A sample cache configuration is provided [cq-demo.xml](#) located in the `config` directory. Note that Spring interprets the path as a relative path unless it is explicitly preceded by `file:`. The sample configuration starts a server on port 40404 and creates a region named *Stocks*.

Gemfire sinks

There are 2 implementations of the gemfire sink: *gemfire-server* and *gemfire-json-server*. They are identical except the latter converts JSON string payloads to a JSON document format proprietary to GemFire and provides JSON field access and query capabilities. If you are not using JSON, the *gemfire-server* module will write the payload using java serialization to the configured region. Both modules accept the same options.

The **gemfire-server** sink has the following options:

host

host name of the cache server or locator (if `useLocator=true`). May be a comma delimited list (**String, no default**)

keyExpression

a SpEL expression which is evaluated to create a cache key (**String, default: '<stream name>'**)

port

port of the cache server or locator (if `useLocator=true`). May be a comma delimited list (**String, no default**)

regionName

name of the region to use when storing data (**String, default: <stream name>**)

useLocator

indicates whether a locator is used to access the cache server (**boolean, default: false**)

Tip

The `keyExpression`, as its name suggests, is a SpEL. Typically, the key value is derived from the payload. The default of '`<streamname>`' (mind the quotes), will overwrite the same entry for every message received on the stream.

Note

The `useLocator` option is intended for integration with an existing GemFire installation in which the cache servers are configured to use locators in accordance with best practice. GemFire

supports configuration of multiple locators (or direct server connections) and this is specified by supplying comma-delimited values for the `host` and `port` options. You may specify a single value for either of these options otherwise each value must contain the same size list. The following are examples are valid for multiple connection addresses:

```
gemfire-server --host=myhost --port=10334,10335
gemfire server --host=myhost1,myhost2 --port=10334
gemfire server --host=myhost1,myhost2,myhost3 --port=10334,10335,10336
```

The last example creates connections to `myhost1:10334`, `myhost2:10335`, `myhost3:10336`

Note

You may also configure default Gemfire connection settings for all gemfire modules in `config/modules.yml`:

```
gemfire:
  useLocator: true
  host: myhost1,myhost2
  port: 10334
```

Example

Suppose we have a JSON document containing a stock price:

```
{"symbol": "FAKE", "price": 73}
```

We want this to be cached using the stock symbol as the key. The stream definition is:

```
http | gemfire-json-server --regionName=Stocks --keyExpression=payload.getField('symbol')
```

The `keyExpression` is a SpEL expression that depends on the payload type. In this case, `com.gemstone.org.json.JSONObject`. `JSONObject` which provides the `getField` method. To run this example:

```
xd> stream create --name stocks --definition "http --port=9090 | gemfire-json-server --
regionName=Stocks --keyExpression=payload.getField('symbol')" --deploy
```

```
xd> http post --target http://localhost:9090 --data {"symbol": "FAKE", "price": 73}
```

This will write an entry to the GemFire `Stocks` region with the key `FAKE`. Please do not put spaces when separating the JSON key-value pairs, only a comma.

You should see a message on STDOUT for the process running the GemFire server like:

```
INFO [LoggingCacheListener] - updated entry FAKE
```

Tip

If you are deploying on Java 7 or earlier and need to deploy more than 4 Gemfire modules, be sure to increase the permsize of the singlenode or container. i.e. `JAVA_OPTS="-XX:PermSize=256m"`.

14.13 Splunk Server

A [Splunk](#) sink that writes data to a TCP Data Input type for Splunk.

Splunk sinks

The Splunk sink converts an object payload to a string using the object's `toString` method and then converts this to a `SplunkEvent` that is sent via TCP to Splunk.

The **splunk** sink has the following options:

host

the host name or IP address of the Splunk server (**String, default: localhost**)

owner

the owner of the tcpPort (**String, default: admin**)

password

the password associated with the username (**String, default: password**)

port

the TCP port number of the Splunk server (**int, default: 8089**)

tcpPort

the TCP port number to where XD will send the data (**int, default: 9500**)

username

the login name that has rights to send data to the tcpPort (**String, default: admin**)

How To Setup Splunk for TCP Input

1. From the Manager page select `Manage Inputs` link
2. Click the `Add data` Button
3. Click the `From a TCP port` link
4. `TCP Port` enter the port you want Splunk to monitor
5. `Set Source Type` select `Manual`
6. `Source Type` enter `tcp-raw`
7. Click `Save`

Example

An example stream would be to take data from a twitter search and push it through to a splunk instance.

```
xd:> stream create --name springone2gx --definition "twittersearch --consumerKey= --consumerSecret= --
query='#LOTR' | splunk" --deploy
```

14.14 MQTT Sink

The `mqtt` sink connects to an mqtt server and publishes telemetry messages.

Options

The **mqtt** sink has the following options:

async

whether or not to use async sends (**boolean, default: false**)

charset

the charset used to convert a String payload to byte[] (**String, default: UTF-8**)

cleanSession

whether the client and server should remember state across restarts and reconnects (**boolean, default: true**)

clientId

identifies the client (**String, default: xd.mqtt.client.id.snk**)

connectionTimeout

the connection timeout in seconds (**int, default: 30**)

keepAliveInterval

the ping interval in seconds (**int, default: 60**)

password

the password to use when connecting to the broker (**String, default: guest**)

persistence

'memory' or 'file' (**String, default: memory**)

persistenceDirectory

file location when using 'file' persistence (**String, default: /tmp/paho**)

qos

the quality of service to use (**int, default: 1**)

retained

whether to set the 'retained' flag (**boolean, default: false**)

topic

the topic to which the sink will publish (**String, default: xd.mqtt.test**)

url

location of the mqtt broker(s) (comma-delimited list) (**String, default: tcp://localhost:1883**)

username

the username to use when connecting to the broker (**String, default: guest**)

Note

The defaults are set up to connect to the RabbitMQ MQTT adapter on localhost.

14.15 Dynamic Router

The Dynamic Router support allows for routing Spring XD messages to **named channels** based on the evaluation of SpEL expressions or Groovy Scripts.

SpEL-based Routing

In the following example, 2 streams are created that listen for message on the **foo** and the **bar** channel. Furthermore, we create a stream that receives messages via HTTP and then delegates the received messages to a router:

```

xd:>stream create f --definition "queue:foo > transform --expression=payload+'-foo' | log" --deploy
Created new stream 'f'

xd:>stream create b --definition "queue:bar > transform --expression=payload+'-bar' | log" --deploy
Created new stream 'b'

xd:>stream create r --definition "http | router --
expression=payload.contains('a')?'queue:foo':'queue:bar'" --deploy
Created new stream 'r'

```

Now we make 2 requests to the HTTP source:

```

xd:>http post --data "a"
> POST (text/plain;Charset=UTF-8) http://localhost:9000 a
> 200 OK

xd:>http post --data "b"
> POST (text/plain;Charset=UTF-8) http://localhost:9000 b
> 200 OK

```

In the server log you should see the following output:

```

11:54:19,868 WARN ThreadPoolTaskScheduler-1 sink.f:145 - a-foo
11:54:25,669 WARN ThreadPoolTaskScheduler-1 sink.b:145 - b-bar

```

For more information, please also consult the Spring Integration Reference manual: <http://static.springsource.org/spring-integration/reference/html/messaging-routing-chapter.html#router-namespace> particularly the section "Routers and the Spring Expression Language (SpEL)".

Groovy-based Routing

Instead of SpEL expressions, Groovy scripts can also be used. Let's create a Groovy script in the file system at `"/my/path/router.groovy"`

```

println("Groovy processing payload '" + payload + "'");
if (payload.contains('a')) {
    return ":foo"
}
else {
    return ":bar"
}

```

Now we create the following streams:

```

xd:>stream create f --definition ":foo > transform --expression=payload+'-foo' | log" --deploy
Created new stream 'f'

xd:>stream create b --definition ":bar > transform --expression=payload+'-bar' | log" --deploy
Created new stream 'b'

xd:>stream create g --definition "http | router --script='file:/my/path/router.groovy'" --deploy

```

Now post some data to the HTTP source:

```

xd:>http post --data "a"
> POST (text/plain;Charset=UTF-8) http://localhost:9000 a
> 200 OK

xd:>http post --data "b"
> POST (text/plain;Charset=UTF-8) http://localhost:9000 b
> 200 OK

```

In the server log you should see the following output:

```
Groovy processing payload 'a'
11:29:27,274 WARN ThreadPoolTaskScheduler-1 sink.f:145 - a-foo
Groovy processing payload 'b'
11:34:09,797 WARN ThreadPoolTaskScheduler-1 sink.b:145 - b-bar
```

Note

You can also use Groovy scripts located on your classpath by specifying:

```
--script='org/my/package/router.groovy'
```

If you want to pass variable values to your script, you can statically bind values using the *variables* option or optionally pass the path to a properties file containing the bindings using the *propertiesLocation* option. All properties in the file will be made available to the script as variables. You may specify both *variables* and *propertiesLocation*, in which case any duplicate values provided as *variables* override values provided in *propertiesLocation*. Note that *payload* and *headers* are implicitly bound to give you access to the data contained in a message.

For more information, see the Spring Integration Reference manual: "Groovy support" <http://static.springsource.org/spring-integration/reference/html/messaging-endpoints-chapter.html#groovy>

Options

The **router** sink has the following options:

expression

a SpEL expression used to transform messages (**String, default: `payload.toString()`**)

propertiesLocation

the path of a properties file containing custom script variable bindings (**String, no default**)

script

reference to a script used to process messages (**String, no default**)

variables

variable bindings as a comma delimited string of name-value pairs, e.g., 'foo=bar,baz=car' (**String, no default**)

Tip

If the `script` option is set, the script is checked for updates every 60 seconds.

14.16 Null Sink

Null sink can be useful when the main stream isn't focused on stream destination but the tap streams are used for analytics etc., It is also useful to iteratively add in steps to a stream without worrying about having to land data anywhere.

For example,

```
xd:>stream create nullStream --definition "http | null" --deploy
Created and deployed new stream 'nullStream'
xd:>stream create tap1 --definition "tap:stream:nullStream > counter" --deploy
Created and deployed new stream 'tap1'
```

In the above, the null sink can be useful as we can create as many number of tap streams off the main stream while we set the main stream sink as null.

14.17 Redis

Redis sink can be used to ingest data into redis store. You can choose `queue`, `topic` or `key` with selected collection type to point to a specific data store.

For example,

```
xd:>stream create store-into-redis --definition "http | redis --queue=myList" --deploy
xd:>Created and deployed new stream 'store-into-redis'
```

Options

The **redis** sink has the following options:

collectionType

the collection type to use for the given key (**CollectionType**, **default: LIST**, **possible values: LIST, SET, ZSET, MAP, PROPERTIES**)

database

database index used by the connection factory (**int**, **default: 0**)

hostname

redis host name (**String**, **default: localhost**)

key

name for the key (**String**, **no default**)

keyExpression

a SpEL expression to use for keyExpression (**String**, **no default**)

maxActive

max number of connections that can be allocated by the pool at a given time; negative value for no limit (**int**, **default: 8**)

maxIdle

max number of idle connections in the pool; a negative value indicates an unlimited number of idle connections (**int**, **default: 8**)

maxWait

max amount of time (in milliseconds) a connection allocation should block before throwing an exception when the pool is exhausted; negative value to block indefinitely (**int**, **default: -1**)

minIdle

target for the minimum number of idle connections to maintain in the pool; only has an effect if it is positive (**int**, **default: 0**)

password

redis password (**String**, **default: ``**)

port

redis port (**int**, **default: 6379**)

queue

name for the queue (**String, no default**)

queueExpression

a SpEL expression to use for queue (**String, no default**)

sentinelMaster

name of Redis master server (**String, default: ``**)

sentinelNodes

comma-separated list of host:port pairs (**String, default: ``**)

topic

name for the topic (**String, no default**)

topicExpression

a SpEL expression to use for topic (**String, no default**)

14.18 Kafka Sink

Kafka sink can be used to ingest data into a specific Kafka topic configuration.

For example,

```
xd:>stream create push-to-kafka --definition "http | kafka --topic=myTopic" --deploy
xd:>Created and deployed new stream 'push-to-kafka'
xd:>http post --data "push-messages"
> POST (text/plain;Charset=UTF-8) http://localhost:9000 push-messages
> 200 OK
```

Now, the posted messages will be available on kafka topic `myTopic`.

The **kafka** sink has the following options:

batchCount

the number of messages to send in one batch when using async mode (**int, default: 200**)

brokerList

comma separated broker list (**String, default: localhost:9092**)

compressedTopics

comma separated list of topics to apply the compression codec (**String, default: ``**)

compressionCodec

compression codec to use (**String, default: none**)

encoding

string encoder to translate bytes into string (**String, default: UTF8**)

enqueueTimeout

the amount of time to block before dropping messages when running in async mode (**int, default: -1**)

maxBufferMsgs

the maximum number of unsent messages that can be queued up the async producer (**int, default: 10000**)

maxBufferTime

maximum time in milliseconds to buffer data when using async mode (**int, default: 5000**)

maxSendRetries

number of attempts to automatically retry a failed send request (**int, default: 3**)

producerType

producer type (**String, default: sync**)

requestRequiredAck

producer request acknowledgement mode (**int, default: 0**)

requestTimeout

timeout in milliseconds after waiting for request required ack (**int, default: 10000**)

retryBackoff

amount of time the producer waits before refreshing the metadata (**int, default: 100**)

socketBufferSize

socket write buffer size (**int, default: 102400**)

topic

kafka topic name (**String, default: <stream name>**)

topicMetadataRefreshInterval

topic metadata refresh interval (**int, default: 600000**)

15. Taps

15.1 Introduction

A Tap allows you to "listen" to data while it is processed in an existing stream and process the data in a separate stream. The original stream is unaffected by the tap and isn't aware of its presence, similar to a phone wiretap. ([WireTap](#) is included in the standard catalog of EAI patterns and [implemented in](#) the Spring Integration EAI framework used by Spring XD).

Simply put, a Tap is a stream that uses a point in another stream as a source.

Example

The following XD shell commands create a stream `foo1` and a tap named `fooltap`:

```
xd:> stream create --name foo1 --definition "time | log" --deploy
xd:> stream create --name fooltap --definition "tap:stream:foo1 > log" --deploy
```

Since a tap is a type of stream, use the `stream create` command to create the tap. The tap source is specified using the [named channel syntax](#) and always begins with `tap:`. In this case, we are tapping the stream named `foo1` specified by `:stream:foo1`

Note

`stream:` is required in this case as it is possible to tap alternate XD targets such as jobs. This tap consumes data at the source of the target stream.

A tap can consume data from any point along the target stream's processing pipeline. XD provides a few ways to tap a stream after a given processor has been applied:

Example - tap after a processor has been applied

If the module name is unique in the target stream, use `tap:stream:<stream_name>.<module_name>`

If you have a stream called `mystream`, defined as

```
http | filter --expression=payload.startsWith('A') | transform --expression=payload.toLowerCase() | file
```

Create a tap after the filter is applied using

```
tap:stream:mystream.filter > ....
```

Example - using a label

You may also use labels to create an alias for a module and reference the label in the tap

If you have a stream called `mystream`, defined as

```
http | transform --expression=payload.toLowerCase() | flibble: transform --
expression=payload.substring(3) | file
```

Create a tap after the second transformer is applied using

```
tap:stream:mystream.flibble > ....
```

A primary use case for a Tap is to perform realtime analytics at the same time as data is being ingested via its primary stream. For example, consider a Stream of data that is consuming Twitter search results and writing them to HDFS. A tap can be created before the data is written to HDFS, and the data piped from the tap to a counter that correspond to the number of times specific hashtags were mentioned in the tweets.

Creating a tap on a named channel, a stream whose source is a named channel, or a label is not yet supported. This is planned for a future release.

You'll find specific examples of creating taps on existing streams in the [Analytics](#) section.

Note

In cases where a multiple modules with the same module name, a label must be specified on the module to be tapped. For example if you want to tap the 2nd transform: `http | transform --expression=payload.toLowerCase() | tapMe: transform --expression=payload.substring(3) | file`

15.2 Tap Lifecycle

A side effect of a stream being unaware of any taps on its pipeline is that deleting the stream will not automatically delete the taps. The taps have to be deleted separately. However if the tapped stream is re-created, the existing tap will continue to function.

16. Analytics

16.1 Introduction

Spring XD provides support for the real-time evaluation of various machine learning scoring algorithms as well simple real-time data analytics using various types of counters and gauges. The analytics functionality is provided via modules that can be added to a stream. In that sense, real-time analytics is accomplished via the same exact model as data-ingestion. It's possible that the primary role of a stream is to perform real-time analytics, but it's quite common to add a [tap](#) to initiate a secondary stream where analytics, e.g. a field-value-counter, is applied to the same data being ingested through a primary stream. You will see both approaches in the examples below.

16.2 Predictive analytics

Spring XD's support for implementing predictive analytics by scoring analytical models that leverage machine learning algorithms begins with an extensible class library foundation upon which implementations can be built, such as the [PMML Module](#) that we describe here.

That module integrates with the [JPMML-Evaluator](#) library that provides support for a wide range of [model types](#) and is interoperable with models exported from [R](#), [Rattle](#), [KNIME](#), and [RapidMiner](#). For counter and gauge analytics, in-memory and [Redis](#) implementations are provided.

Incorporating the evaluation of machine learning algorithms into stream processing is as easy as using any other processing module. Here is a simple example

```
http --outputType=application/x-xd-tuple | analytic-pmml
--location=/models/iris-flower-naive-bayes.pmml.xml
--inputFieldMapping=
'sepalLength:Sepal.Length,
  sepalWidth:Sepal.Width,
  petalLength:Petal.Length,
  petalWidth:Petal.Width'
--outputFieldMapping='Predicted_Species:predictedSpecies' | log"
```

The `http` source converts posted data to a Tuple. The `analytic-pmml` processor loads the model from the specified file and creates two mappings so that fields from the Tuple can be mapped into the input and output model names. The `log` sink writes the payload of the event message to the log file of the XD container.

Posting the following JSON data to the `http` source

```
{
  "sepalLength": "6.4",
  "sepalWidth": "3.2",
  "petalLength": "4.5",
  "petalWidth": "1.5"
}
```

will produce output in the log file as shown below.

```
{
  "id": "1722ec00-baad-11e3-b988-005056c00008",
  "timestamp": 1396473833152,
  "sepalLength": "6.4",
  "sepalWidth": "3.2",
  "petalLength": "4.5",
  "petalWidth": "1.5",
  "predictedSpecies": "versicolor"
}
```

The next section on analytical models goes into more detail on the general infrastructure

16.3 Analytical Models

We provide some core abstractions for implementing analytical models in stream processing applications. The main interface for integrating analytical models is **Analytic**. Some analytical models need to adjust the domain input and the model output in some way, therefore we provide a special base class **MappedAnalytic** which has core abstractions for implementing that mapping via **InputMapper** and **OutputMapper**.

Since **Spring XD 1.0.0.M6** we support the integration of analytical models, also called statistical models or mining models, that are defined via **PMML**. **PMML** is the abbreviation for **Predictive Model Markup Language** and is a standard XML representation that allows specifications of different mining models, their ensembles, and associated preprocessing.

Note

PMML is maintained by the **Data Mining Group (DMG)** and supported by several state-of-the-art statistics and data mining software tools such as InfoSphere Warehouse, R / Rattle, SAS Enterprise Miner, SPSS®, and Weka. The current version of the **PMML** specification is [4.2](#) at the time of this writing. Applications can produce and consume **PMML** models, thus allowing an analytical model created in one application to be implemented and used for scoring or prediction in another.

PMML is just one of many other technologies that one can integrate to implement analytics with, more will follow in upcoming releases.

Modeling and Evaluation

Analytical models are usually defined by a statistician *aka* data scientist or quant by using some statistical tool to analyze the data and build an appropriate model. In order to implement those models in a business application they are usually transformed and exported in some way (e.g. in the form of a **PMML** definition). This model is then loaded into the application which then evaluates it against a given input (event, tuple, example).

Modeling

Analytical models can be defined in various ways. For the sake of brevity we use **R** from the [r-project](#) to demonstrate how easy it is to export an analytical model to **PMML** and use it later in stream processing.

For our example we use the [iris](#) example dataset in **R** to generate a classifier for iris flower species by applying the [Naive Bayes](#) algorithm.

```
library(e1071) # Load library with the naive bayes algorithm support.

library(pmml) # Load library with PMML export support.

data(iris) # Load the IRIS example dataset

#Helper function to split the given dataset into a dataset used for training (trainset) and (testset)
used for evaluation.
splitDataFrame <- function(dataframe, seed = NULL, n = trainSize) {

  if (!is.null(seed)){
    set.seed(seed)
  }

  index <- 1:nrow(dataframe)
  trainindex <- sample(index, n)
  trainset <- dataframe[trainindex, ]
  testset <- dataframe[-trainindex, ]

  list(trainset = trainset, testset = testset)
}

#We want to use 95% of the IRIS data as training data and 5% as test data for evaluation.
datasets <- splitDataFrame(iris, seed = 1337, n= round(0.95 * nrow(iris)))

#Create a naive Bayes classifier to predict iris flower species (iris[,5]) from [,1:4] = Sepal.Length
Sepal.Width Petal.Length Petal.Width
model <- naiveBayes(datasets$trainset[,1:4], datasets$trainset[,5])

#The name of the model and it's externalId could be used to uniquely identify this version of the model.
modelName = "iris-flower-classifier"
externalId = 42

#Convert the given model into a PMML model definition
pmmlDefinition = pmml.naiveBayes(model,model.name=paste(modelName,externalId,sep = ";"),
  predictedField='Species')

#Print the PMML definition to stdout
cat(toString(pmmlDefinition))
```

The r script above should produce the following **PMML** document that contains the abstract definition of the naive bayes classifier that we derived from the training dataset of the IRIS dataset.

```

<PMML version="4.1" xmlns="http://www.dmg.org/PMML-4_1" xmlns:xsi="http://www.w3.org/2001/XMLSchema-
instance" xsi:schemaLocation="http://www.dmg.org/PMML-4_1 http://www.dmg.org/v4-1/pmml-4-1.xsd">
<Header copyright="Copyright (c) 2014 tom" description="NaiveBayes Model">
  <Extension name="user" value="tom" extender="Rattle/PMML"/>
  <Application name="Rattle/PMML" version="1.4"/>
  <Timestamp>2014-04-02 13:22:15</Timestamp>
</Header>
<DataDictionary numberOfFields="6">
  <DataField name="Species" optype="categorical" dataType="string">
    <Value value="setosa"/>
    <Value value="versicolor"/>
    <Value value="virginica"/>
  </DataField>
  <DataField name="Sepal.Length" optype="continuous" dataType="double"/>
  <DataField name="Sepal.Width" optype="continuous" dataType="double"/>
  <DataField name="Petal.Length" optype="continuous" dataType="double"/>
  <DataField name="Petal.Width" optype="continuous" dataType="double"/>
  <DataField name="DiscretePlaceholder" optype="categorical" dataType="string">
    <Value value="pseudoValue"/>
  </DataField>
</DataDictionary>
<NaiveBayesModel modelName="iris-flower-classifier;42"
  functionName="classification" threshold="0.001">
  <MiningSchema>
    <MiningField name="Species" usageType="predicted"/>
    <MiningField name="Sepal.Length" usageType="active"/>
    <MiningField name="Sepal.Width" usageType="active"/>
    <MiningField name="Petal.Length" usageType="active"/>
    <MiningField name="Petal.Width" usageType="active"/>
    <MiningField name="DiscretePlaceholder" usageType="active"
      missingValueReplacement="pseudoValue"/>
  </MiningSchema>
  <Output>
    <OutputField name="Predicted_Species" feature="predictedValue"/>
    <OutputField name="Probability_setosa" optype="continuous"
      dataType="double" feature="probability" value="setosa"/>
    <OutputField name="Probability_versicolor" optype="continuous"
      dataType="double" feature="probability" value="versicolor"/>
    <OutputField name="Probability_virginica" optype="continuous"
      dataType="double" feature="probability" value="virginica"/>
  </Output>
  <BayesInputs>
    <Extension>
      <BayesInput fieldName="Sepal.Length">
        <TargetValueStats>
          <TargetValueStat value="setosa">
            <GaussianDistribution mean="5.006" variance="0.124248979591837"/>
          </TargetValueStat>
          <TargetValueStat value="versicolor">
            <GaussianDistribution mean="5.8953488372093" variance="0.283311184939092"/>
          </TargetValueStat>
          <TargetValueStat value="virginica">
            <GaussianDistribution mean="6.58163265306122" variance="0.410697278911565"/>
          </TargetValueStat>
        </TargetValueStats>
      </BayesInput>
    </Extension>
    <Extension>
      <BayesInput fieldName="Sepal.Width">
        <TargetValueStats>
          <TargetValueStat value="setosa">
            ...

```

```

...
    <GaussianDistribution mean="3.428" variance="0.143689795918367"/>
  </TargetValueStat>
  <TargetValueStat value="versicolor">
    <GaussianDistribution mean="2.76279069767442" variance="0.0966777408637874"/>
  </TargetValueStat>
  <TargetValueStat value="virginica">
    <GaussianDistribution mean="2.97142857142857" variance="0.105833333333333"/>
  </TargetValueStat>
</TargetValueStats>
</BayesInput>
</Extension>
<Extension>
  <BayesInput fieldName="Petal.Length">
    <TargetValueStats>
      <TargetValueStat value="setosa">
        <GaussianDistribution mean="1.462" variance="0.0301591836734694"/>
      </TargetValueStat>
      <TargetValueStat value="versicolor">
        <GaussianDistribution mean="4.21627906976744" variance="0.236633444075305"/>
      </TargetValueStat>
      <TargetValueStat value="virginica">
        <GaussianDistribution mean="5.55510204081633" variance="0.310442176870748"/>
      </TargetValueStat>
    </TargetValueStats>
  </BayesInput>
</Extension>
<Extension>
  <BayesInput fieldName="Petal.Width">
    <TargetValueStats>
      <TargetValueStat value="setosa">
        <GaussianDistribution mean="0.246" variance="0.0111061224489796"/>
      </TargetValueStat>
      <TargetValueStat value="versicolor">
        <GaussianDistribution mean="1.30697674418605" variance="0.042093023255814"/>
      </TargetValueStat>
      <TargetValueStat value="virginica">
        <GaussianDistribution mean="2.02448979591837" variance="0.0768877551020408"/>
      </TargetValueStat>
    </TargetValueStats>
  </BayesInput>
</Extension>
  <BayesInput fieldName="DiscretePlaceholder">
    <PairCounts value="pseudoValue">
      <TargetValueCounts>
        <TargetValueCount value="setosa" count="50"/>
        <TargetValueCount value="versicolor" count="43"/>
        <TargetValueCount value="virginica" count="49"/>
      </TargetValueCounts>
    </PairCounts>
  </BayesInput>
</BayesInputs>
  <BayesOutput fieldName="Species">
    <TargetValueCounts>
      <TargetValueCount value="setosa" count="50"/>
      <TargetValueCount value="versicolor" count="43"/>
      <TargetValueCount value="virginica" count="49"/>
    </TargetValueCounts>
  </BayesOutput>
</NaiveBayesModel>
</PMML>

```

Evaluation

The above defined **PMML** model can be evaluated in a Spring XD stream definition by using the **analytic-pmml** module as a processor in your stream definition. The actual evaluation of the **PMML** is performed via the **PmmlAnalytic** which uses the [jpmml-evaluator](#) library.

Model Selection

The PMML standard allows multiple models to be defined within a single PMML document. The model to be used can be configured through the **modelName** option.

NOTE The PMML standard also supports other ways for selection models, e.g. based on a predicate. This is currently not supported.

In order to perform the evaluation in Spring XD you need to save the generated PMML document to some folder, typically the with the extension "pmml.xml". For this example we save the PMML document under the name **iris-flower-classification-naive-bayes-1.pmml.xml**.

In the following example we set up a stream definition with an `http` source that produces iris-flower-records that are piped to the `analytic-pmml` module which applies our iris flower classifier to predict the species of a given flower record. The result of that is a new record extended by a new attribute **predictedSpecies** which simply sent to a `log` sink.

The definition of the stream, which we call **iris-flower-classification**, looks as follows:

```
xd:>stream create --name iris-flower-classification
--definition "http --outputType=application/x-xd-tuple | analytic-pmml
--location=/models/iris-flower-classification-naive-bayes-1.pmml.xml
--inputFieldMapping='sepalLength:Sepal.Length,
                    sepalWidth:Sepal.Width,
                    petalLength:Petal.Length,
                    petalWidth:Petal.Width'
--outputFieldMapping='Predicted_Species:predictedSpecies' | log" --deploy
```

- The **location** parameter can be used to specify the exact location of the pmml document. The value must be a valid spring [resource](#) location
- The **inputFieldMapping** parameter defines a mapping of domain input fields to model input fields. It is just a list of fields or optional field:alias mappings to control which fields and how they are going to end up in the model-input. If no inputFieldMapping is defined then all domain input fields are used as model input.
- The **outputFieldMapping** parameter defines a mapping of model output fields to domain output fields with semantics analog to the inputFieldMapping.
- The optional **modelName** parameter of the analytic-pmml module can be used to refer to a particular named model within the PMML definition. If modelName is not defined the first model is selected by default.

NOTE Some analytical models like for instance **association rules** require a different typ of mapping. You can implement your own custom mapping strategies by implementing a custom **InputMapper** and **OutputMapper** and defining a new **PmmlAnalytic** or **TuplePmmlAnalytic** bean that uses your custom mappers.

After the stream has been successfully deployed to **Spring XD** we can eventually start to throw some data at it by issuing the following http request via the **XD-Shell** (or `curl`, or any other tool):

Note that our example record contains no information about which species the example belongs to - this will be added by our classifier.

```
xd:>http post --target http://localhost:9000 --contentType application/json --data "{ \"sepalLength\":
6.4, \"sepalWidth\": 3.2, \"petalLength\":4.5, \"petalWidth\":1.5 }"
```

After posting the above json document to the stream we should see the following output in the console:

```
{
  "id": "1722ec00-baad-11e3-b988-005056c00008"
  , "timestamp": 1396473833152
  , "sepalLength": "6.4"
  , "sepalWidth": "3.2"
  , "petalLength": "4.5"
  , "petalWidth": "1.5"
  , "predictedSpecies": "versicolor"
}
```

NOTE the generated field **predictedSpecies** which now identifies our input as belonging to the iris species **versicolor**.

We verify that the generated **PMML** classifier produces the same result as **R** by executing the issuing the following commands in **rproject**:

```
datasets$testset[,1:4][1,]
# This is the first example record that we sent via the http post.
  Sepal.Length Sepal.Width Petal.Length Petal.Width
52           6.4         3.2         4.5         1.5

#Predict the class for the example record by using our naiveBayes model.
> predict(model, datasets$testset[,1:4][1,])
[1] versicolor
```

16.4 Counters and Gauges

Counter and Gauges are analytical data structures collectively referred to as metrics. Metrics can be used directly in place of a sink just as if you were creating any other [stream](#), but you can also analyze data from an existing stream using a [tap](#). We'll look at some examples of using metrics with taps in the following sections. As a prerequisite start the XD Container as instructed in the [Getting Started](#) page.

The 1.0 release provides the following types of metrics

- [Counter](#)
- [Field Value Counter](#)
- [Aggregate Counter](#)
- [Gauge](#)
- [Rich Gauge](#)

Spring XD supports these metrics and analytical data structures as a general purpose class library that works with several backend storage technologies. The 1.0 release provides in memory and Redis implementations.

Counter

A counter is a Metric that associates a unique name with a long value. It is primarily used for counting events triggered by incoming messages on a target stream. You create a counter with a unique name and optionally an initial value then set its value in response to incoming messages. The most straightforward use for counter is simply to count messages coming into the target stream. That is, its value is incremented on every message. This is exactly what the *counter* module provided by Spring XD does.

Here's an example:

Start by creating a data ingestion stream. Something like:

```
xd:> stream create --name springtweets --definition "twittersearch --consumerKey=<your_key> --
consumerSecret=<your_secret> --query=spring | file --dir=/tweets/" --deploy
```

Next, create a tap on the *springtweets* stream that sets a message counter named *tweetcount*

```
xd:> stream create --name tweettap --definition "tap:stream:springtweets > counter --name=tweetcount" --
deploy
```

To retrieve the count:

```
xd:>counter display tweetcount
```

The **counter** sink has the following options:

name

the name of the metric to contribute to (will be created if necessary) (**String, default: <stream name>**)

nameExpression

a SpEL expression to compute the name of the metric to contribute to (**String, no default**)

Field Value Counter

A field value counter is a Metric used for counting occurrences of unique values for a named field in a message payload. XD Supports the following payload types out of the box:

- POJO (Java bean)
- Tuple
- JSON String

For example suppose a message source produces a payload with a field named *user* :

```
class Foo {
    String user;
    public Foo(String user) {
        this.user = user;
    }
}
```

If the stream source produces messages with the following objects:

```
new Foo("fred")
new Foo("sue")
new Foo("dave")
new Foo("sue")
```

The field value counter on the field *user* will contain:

```
fred:1, sue:2, dave:1
```

Multi-value fields are also supported. For example, if a field contains a list, each value will be counted once:

```
users: ["dave", "fred", "sue"]
users: ["sue", "jon"]
```

The field value counter on the field *users* will contain:

```
dave:1, fred:1, sue:2, jon:1
```

The **field-value-counter** sink has the following options:

fieldName

the name of the field for which values are counted (**String, no default**)

name

the name of the metric to contribute to (will be created if necessary) (**String, default: <stream name>**)

nameExpression

a SpEL expression to compute the name of the metric to contribute to (**String, no default**)

To try this out, create a stream to ingest twitter feeds containing the word *spring* and output to a file:

```
xd:> stream create --name springtweets --definition "twittersearch --consumerKey=<your_key> --
consumerSecret=<your_secret> --query=spring | file" --deploy
```

Now create a tap for a field value counter:

```
xd:> stream create --name fromUserCount --definition "tap:stream:springtweets > field-value-counter --
fieldName=user.screen_name" --deploy
```

The *twittersearch* source produces JSON strings which contain the user id of the tweeter in the *fromUser* field. The *field_value_counter* sink parses the tweet and updates a field value counter named *fromUserCount* in Redis. To view the counts:

```
From xd-shell,
xd:> field-value-counter display fromUserCount
```

Aggregate Counter

The aggregate counter differs from a simple counter in that it not only keeps a total value for the count, but also retains the total count values for each minute, hour day and month of the period for which it is run. The data can then be queried by supplying a start and end date and the resolution at which the data should be returned.

Creating an aggregate counter is very similar to a simple counter. For example, to obtain an aggregate count for our spring tweets stream:

```
xd:> stream create --name springtweets --definition "twittersearch --query=spring | file" --deploy
```

you'd simply create a tap which pipes the input to *aggregate-counter*:

```
xd:> stream create --name tweettap --definition "tap:stream:springtweets > aggregate-counter --
name=tweetcount" --deploy
```

From the XD shell:

```
xd:> aggregate-counter display tweettap
```

Note: you can also use some criteria to filter out aggregate counter display values. Please refer to Shell documentation for aggregate counter for more details.

The **aggregate-counter** sink has the following options:

`dateFormat`

a pattern (as in `SimpleDateFormat`) for parsing/formatting dates and timestamps (**String, default: `yyyy-MM-dd'T'HH:mm:ss.SSS'Z'`**)

`incrementExpression`

how much to increment each bucket, as a SpEL against the message (**String, default: `1`**)

`name`

the name of the metric to contribute to (will be created if necessary) (**String, default: `<stream name>`**)

`nameExpression`

a SpEL expression to compute the name of the metric to contribute to (**String, no default**)

`timeField`

name of a field in the message that contains the timestamp to contribute to (**String, default: `null`**)

Gauge

A gauge is a Metric, similar to a counter in that it holds a single long value associated with a unique name. In this case the value can represent any numeric value defined by the application.

The *gauge* sink provided with XD stores expects a numeric value as a payload, typically this would be a decimal formatted string.

The **gauge** sink has the following options:

`name`

the name of the metric to contribute to (will be created if necessary) (**String, default: `<stream name>`**)

`nameExpression`

a SpEL expression to compute the name of the metric to contribute to (**String, no default**)

Here is an example of creating a tap for a gauge:

Simple Tap Example

Create an ingest stream

```
xd> stream create --name test --definition "http --port=9090 | file" --deploy
```

Next create the tap:

```
xd> stream create --name simplegauge --definition "tap:stream:test > gauge" --deploy
```

Now Post a message to the ingest stream:

```
xd> http post --target http://localhost:9090 --data "10"
```

Check the gauge:

```
xd:>gauge display --name simplegauge
```

Rich Gauge

A rich gauge is a Metric that holds a double value associated with a unique name. In addition to the value, the rich gauge keeps a running average, along with the minimum and maximum values and the sample count.

The *rich-gauge* sink provided with XD expects a numeric value as a payload, typically this would be a decimal formatted string, and keeps its value in a store.

The **rich-gauge** sink has the following options:

alpha

smoothing constant, or -1 to use arithmetic mean (**double, default: -1.0**)

name

the name of the metric to contribute to (will be created if necessary) (**String, default: <stream name>**)

nameExpression

a SpEL expression to compute the name of the metric to contribute to (**String, no default**)

Note

The smoothing factor behaves as an [exponential moving average](#). The default value does no smoothing.

Here are some examples of creating a tap for a rich gauge:

Simple Tap Example

Create an ingest stream

```
xd:> stream create --name test --definition "http --port=9090 | file" --deploy
```

Next create the tap:

```
xd:> stream create --name testgauge --definition "tap:stream:test > rich-gauge" --deploy
```

Now Post some messages to the ingest stream:

```
xd:> http post --target http://localhost:9090 --data "10"
xd:> http post --target http://localhost:9090 --data "13"
xd:> http post --target http://localhost:9090 --data "16"
```

Check the gauge:

```
xd:>rich-gauge display testgauge
```

Stock Price Example

In this example, we will track stock prices, which is a more practical example. The data is ingested as JSON strings like

```
{"symbol": "VMW", "price": 72.04}
```

Create an ingest stream

```
xd:> stream create --name stocks --definition "http --port=9090 | file"
```

Next create the tap, using the transform module to extract the stock price from the payload:

```
xd:> stream create --name stockprice --definition "tap:stream:stocks > transform --expression=#jsonPath(payload, '$.price') | rich-gauge"
```

Now Post some messages to the ingest stream:

```
xd:> http post --target http://localhost:9090 --data {"symbol": "VMW", "price": 72.04}
xd:> http post --target http://localhost:9090 --data {"symbol": "VMW", "price": 72.06}
xd:> http post --target http://localhost:9090 --data {"symbol": "VMW", "price": 72.08}
```

Note: JSON fields should be separated by a comma without any spaces. Alternatively, enclose the whole argument to `--data` with quotes and escape inner quotes with a backslash.

Check the gauge:

```
xd:>rich-gauge display stockprice
```

Improved Stock Price Example

In this example, we will track stock prices for selected stocks. The data is ingested as JSON strings like

```
{"symbol": "VMW", "price": 72.04}
{"symbol": "EMC", "price": 24.92}
```

The previous example would feed these prices to a single gauge. What we really want is to create a separate tap for each ticker symbol in which we are interested:

Create an ingest stream

```
xd:> stream create --name stocks --definition "http --port=9090 | file"
```

Next create the tap, using the transform module to extract the stock price from the payload:

```
xd:> stream create --name vmwprice --definition "tap:stream:stocks > filter --expression=#jsonPath(payload, '$.symbol')==VMW | transform --expression=#jsonPath(payload, '$.price') | rich-gauge" --deploy
xd:> stream create --name emcprice --definition "tap:stream:stocks > filter --expression=#jsonPath(payload, '$.symbol')==EMC | transform --expression=#jsonPath(payload, '$.price') | rich-gauge" --deploy
```

Now Post some messages to the ingest stream:

```
xd:> http post --target http://localhost:9090 --data {"symbol": "VMW", "price": 72.04}
xd:> http post --target http://localhost:9090 --data {"symbol": "VMW", "price": 72.06}
xd:> http post --target http://localhost:9090 --data {"symbol": "VMW", "price": 72.08}
```

```
xd:> http post --target http://localhost:9090 --data {"symbol": "EMC", "price": 24.92}
xd:> http post --target http://localhost:9090 --data {"symbol": "EMC", "price": 24.90}
xd:> http post --target http://localhost:9090 --data {"symbol": "EMC", "price": 24.96}
```

Check the gauge:

```
xd:>rich-gauge display emcprice
xd:>rich-gauge display vmwprice
```

Accessing Analytics Data over the RESTful API

Spring XD has a discoverable RESTful API based on the Spring HATEAOS library. You can discover the resources available by making a GET request on the root resource of the Admin server. Here is an example where navigate down to find the data for a counter named *httptap* that was created by these commands

```
xd:>stream create --name httpStream --definition "http | file" --deploy
xd:>stream create --name httptap --definition "tap:stream:httpStream > counter" --deploy
xd:>http post --target http://localhost:9000 --data "helloworld"
```

The root resource returns

```
xd:>! wget -q -S -O - http://localhost:9393/
{
  "links":[
    {},
    {
      "rel":"jobs",
      "href":"http://localhost:9393/jobs"
    },
    {
      "rel":"modules",
      "href":"http://localhost:9393/modules"
    },
    {
      "rel":"runtime/modules",
      "href":"http://localhost:9393/runtime/modules"
    },
    {
      "rel":"runtime/containers",
      "href":"http://localhost:9393/runtime/containers"
    },
    {
      "rel":"counters",
      "href":"http://localhost:9393/metrics/counters"
    },
    {
      "rel":"field-value-counters",
      "href":"http://localhost:9393/metrics/field-value-counters"
    },
    {
      "rel":"aggregate-counters",
      "href":"http://localhost:9393/metrics/aggregate-counters"
    },
    {
      "rel":"gauges",
      "href":"http://localhost:9393/metrics/gauges"
    },
    {
      "rel":"rich-gauges",
      "href":"http://localhost:9393/metrics/rich-gauges"
    }
  ]
}
```

Following the resource location for the counter

```
xd:>! wget -q -S -O - http://localhost:9393/metrics/counters
{
  "links":[
  ],
  "content":[
    {
      "links":[
        {
          "rel":"self",
          "href":"http://localhost:9393/metrics/counters/httptap"
        }
      ],
      "name":"httptap"
    }
  ],
  "page":{
    "size":0,
    "totalElements":1,
    "totalPages":1,
    "number":0
  }
}
```

And then the data for the counter itself

```
xd:>! wget -q -S -O - http://localhost:9393/metrics/counters/httptap
{
  "links":[
    {
      "rel":"self",
      "href":"http://localhost:9393/metrics/counters/httptap"
    }
  ],
  "name":"httptap",
  "value":2
}
```

17. Tuples

17.1 Introduction

The `Tuple` class is a central data structure in Spring XD. It is an ordered list of values that can be retrieved by name or by index. Tuples are created by a `TupleBuilder` and are immutable. The values that are stored can be of any type and null values are allowed.

The underlying `Message` class that moves data from one processing step to the next can have an arbitrary data type as its payload. Instead of creating a custom Java class that encapsulates the properties of what is read or set in each processing step, the `Tuple` class can be used instead. Processing steps can be developed that read data from specific named values and write data to specific named values.

There are accessor methods that perform type conversion to the basic primitive types as well as `BigDecimal` and `Date`. This avoids you from having to cast the values to specific types. Instead you can rely on the `Tuple`'s type conversion infrastructure to perform the conversion.

The `Tuple`'s types conversion is performed by Spring's [Type Conversion Infrastructure](#) which supports commonly encountered type conversions and is extensible.

There are several overloads for getters that let you provide default values for primitive types should the field you are looking for not be found. Date format patterns and Locale aware `NumberFormat` conversion are also supported. A best effort has been made to preserve the functionality available in Spring Batch's [FieldSet](#) class that has been extensively used for parsing String based data in files.

Creating a Tuple

The `TupleBuilder` class is how you create new `Tuple` instances. The most basic case is

```
Tuple tuple = TupleBuilder.tuple().of("foo", "bar");
```

This creates a `Tuple` with a single entry, a key of `foo` with a value of `bar`. You can also use a static import to shorten the syntax.

```
import static org.springframework.xd.tuple.TupleBuilder.tuple;

Tuple tuple = tuple().of("foo", "bar");
```

You can use the `of` method to create a `Tuple` with up to 4 key-value pairs.

```
Tuple tuple2 = tuple().of("up", 1, "down", 2);
Tuple tuple3 = tuple().of("up", 1, "down", 2, "charm", 3 );
Tuple tuple4 = tuple().of("up", 1, "down", 2, "charm", 3, "strange", 4);
```

To create a `Tuple` with more than 4 entries use the fluent API that strings together the `put` method and terminates with the `build` method

```
Tuple tuple6 = tuple().put("up", 1)
    .put("down", 2)
    .put("charm", 3)
    .put("strange", 4)
    .put("bottom", 5)
    .put("top", 6)
    .build();
```

To customize the underlying type conversion system you can specify the `DateFormat` to use for converting `String` to `Date` as well as the `NumberFormat` to use based on a `Locale`. For more advanced customization of the type conversion system you can register an instance of a `FormattingConversionService`. Use the appropriate setter methods on `TupleBuilder` to make these customizations.

You can also create a `Tuple` from a list of `String` field names and a `List` of `Object` values.

```
Object[] tokens = new String[]
{ "TestString", "true", "C", "10", "-472", "354224", "543", "124.3", "424.3", "1,3245",
  null, "2007-10-12", "12-10-2007", "" };
String[] nameArray = new String[]
{ "String", "Boolean", "Char", "Byte", "Short", "Integer", "Long", "Float", "Double",
  "BigDecimal", "Null", "Date", "DatePattern", "BlankInput" };

List<String> names = Arrays.asList(nameArray);
List<Object> values = Arrays.asList(tokens);
tuple = tuple().ofNamesAndValues(names, values);
```

Getting Tuple values

There are getters for all the primitive types and also for `BigDecimal` and `Date`. The primitive types are

- Boolean
- Byte
- Char
- Double
- Float
- Int
- Long
- Short
- String

Each getter has an overload for providing a default value. You can access the values either by field name or by index.

The overloaded methods for asking for a value to be converted into an integer are

- `int getInt(int index)`
- `int getInt(String name)`
- `int getInt(int index, int defaultValue)`
- `int getInt(String name, int defaultValue)`

There are similar methods for other primitive types. For `Boolean` there is a special case of providing the `String` value that represents a `trueValue`.

- `boolean getBoolean(int index, String trueValue)`
- `boolean getBoolean(String name, String trueValue)`

If the value that is stored for a given field or index is null and you ask for a primitive type, the standard Java default value for that type is returned.

The `getString` method will remove leading and trailing whitespace. If you want to get the String and preserve whitespace use the methods `getRawString`

There is extra functionality for getting `Date`s. There are overloaded getters that take a String based date format

- `Date getDateWithPattern(int index, String pattern)`
- `Date getDateWithPattern(int index, String pattern, Date defaultValue)`
- `Date getDateWithPattern(String name, String pattern)`
- `Date getDateWithPattern(String name, String pattern, Date defaultValue)`

There are a few other more generic methods available. Their functionality should be obvious from their names

- `size()`
- `getFieldCount()`
- `getFieldNames()`
- `getFieldTypes()`
- `getTimestamp()` - the time the tuple was created - milliseconds since epoch
- `getId()` - the UUID of the tuple
- `Object getValue(int index)`
- `Object getValue(String name)`
- `T getValue(int index, Class<T> valueClass)`
- `T getValue(String name, Class<T> valueClass)`
- `List<Object> getValues()`
- `List<String> getFieldNames()`
- `boolean hasFieldName(String name)`

Using SpEL expressions to filter a tuple

SpEL provides support to transform a source collection into another by selecting from its entries. We make use of this functionality to select a elements of a the tuple into a new one.

```
Tuple tuple = tuple().put("red", "rot")
                    .put("brown", "braun")
                    .put("blue", "blau")
                    .put("yellow", "gelb")
                    .put("beige", "beige")
                    .build();

Tuple selectedTuple = tuple.select("?[key.startsWith('b')]");
assertThat(selectedTuple.size(), equalTo(3));
```

To select the first match use the ^ operator

```
selectedTuple = tuple.select("^key.startsWith('b')");

assertThat(selectedTuple.size(), equalTo(1));
assertThat(selectedTuple.getFieldNames().get(0), equalTo("brown"));
assertThat(selectedTuple.getString(0), equalTo("braun"));
```

Gradle Dependencies

If you wish to use Spring XD Tuples in you project add the following dependencies:

```
//Add this repo to your repositories if it does not already exist.
maven { url "http://repo.spring.io/libs-snapshot" }

//Add this dependency
compile 'org.springframework.xd:spring-xd-tuple:1.2.0.M1'
```

18. Type Conversion

18.1 Introduction

Spring XD allows you to declaratively configure type conversion in stream definitions using the *inputType* and *outputType* module options. Note that general type conversion may also be accomplished easily within a transformer or a custom module. Currently, Spring XD natively supports the following type conversions commonly used in streams:

- **JSON to/from POJO**
- **JSON to/from [org.springframework.xd.tuple.Tuple](#)**
- **Object to/from `byte[]`** : Either the raw bytes serialized for remote transport, bytes emitted by a module, or converted to bytes using Java serialization (requires the object to be `Serializable`)
- **String to/from `byte[]`**
- **Object to plain text** (invokes the object's *toString()* method)

Where *JSON* represents either a byte array or String payload containing JSON. Currently, Objects may be converted from a JSON byte array or String. Converting to JSON always produces a String. Registration of custom type converters is covered [in this section](#).

18.2 MIME types

inputType and *outputType* values are parsed as media types, e.g., `application/json` or `text/plain; charset=UTF-8`. MIME types are especially useful for indicating how to convert to String or `byte[]` content. Spring XD also uses MIME type format to represent Java types, using the general type `application/x-java-object` with a `type` parameter. For example, `application/x-java-object; type=java.util.Map` or `application/x-java-object; type=com.bar.Foo`. For convenience, you can use the class name by itself and Spring XD will translate a valid class name to the corresponding MIME type. In addition, Spring XD provides custom MIME types, notably, `application/x-xd-tuple` to specify a Tuple.

18.3 Stream Definition Examples

18.4 POJO to JSON

Type conversion will likely come up when implementing a custom module which produces or consumes a custom domain object. For example, you want to create a stream that integrates with a legacy system that includes custom domain types in its API. To process custom domain types directly minimally requires these types to be defined in Spring XD's class path. This approach will be cumbersome to maintain when the domain model changes. The recommended approach is to convert such types to JSON at the source, or back to POJO at the sink. You can do this by declaring the required conversions in the stream definition:

```
customPojoSource --outputType=application/json |p1 | p2 | ... | customPojoSink --inputType=application/x-java-object; type=com.acme.MyDomainType
```

Note that the sink above does require the declared type to be in the module's classpath to perform the JSON to POJO conversion. Generally, POJO to JSON does not require the Java class. Once the

payload is converted to JSON, Spring XD provided transformers and filters (p1, p2, etc.) can evaluate the payload contents using [JsonPath functions in SpEL expressions](#). Alternately, you can convert the JSON to a Tuple, as shown in the following example.

JSON to Tuple

Sometimes it is convenient to convert JSON content to a Tuple in order to evaluate and access individual field values.

```
xd:> stream create tuple --definition "http | filter --inputType=application/
x-td-tuple --expression=payload.hasFieldName('hello') | transform --
expression=payload.getString('hello').toUpperCase() | log" --deploy
Created and deployed new stream 'tuple'
```

Note `inputType=application/x-td-tuple` on the filter module will cause the payload to be converted to a Tuple at the filter's input channel. Thus, subsequent expressions are evaluated on a Tuple object. Here we invoke the Tuple methods `hasFieldName('hello')` on the filter and `getString('hello')` on the transformer. The output of the http source is expected to be JSON in this case. We set the `Content-Type` header to tell Spring XD that the payload is JSON.

```
xd:>http post --data {"hello":"world","foo":"bar"} --contentType application/json --target http://
localhost:9000
> POST (application/json;charset=UTF-8) http://localhost:9000 {"hello":"world","foo":"bar"}
> 200 OK
```

In the Spring XD console log, you should see something like:

```
13:19:45,054 INFO pool-42-thread-4 sink.tuple - WORLD
```

Java Serialization

The following serializes a `java.io.Serializable` object to a file. Presumably the `foo` module outputs a `Serializable` type. If not, this will result in an exception. If remote transport is configured, the output of `foo` will be marshalled using Spring XD's internal serialization. The object will be unmarshalled in the `file` module and then converted to a byte array using Java serialization.

```
foo | --inputType=application/x-java-serialized-object file
```

18.5 MIME types and Java types

Internally, Spring XD implements type conversion using Spring Integration's [data type channels](#). The data type channel converts payloads to the configured data type using Spring's [MessageConverter](#).

Note

The use of `MessageConverter` for data type channels was introduced in Spring Integration 4 to pass the Message to the converter method to allow it to access the Message's `content-type` header. This provides greater flexibility. For example, it is now possible to support multiple strategies for converting a String or byte array to a POJO, based on the content-type header.

When Spring XD deploys a module with a declared type conversion, it modifies the module's input and/or output channel definition to set the required Java type and registers `MessageConverters` associated with the target MIME type and Java type to the channel. The type conversions Spring XD provides out of the box are summarized in the following table:

Source Payload	Target Payload	content-type header	outputType/ inputType	Comments
POJO	JSON String	ignored	application/json	
Tuple	JSON String	ignored	application/json	JSON is tailored for Tuple
POJO	String (toString())	ignored	text/plain, java.lang.String	
POJO	byte[] (java.io serialized)	ignored	application/x-java-serialized-object	
JSON byte[] or String	POJO	application/json (or none)	application/x-java-object	
byte[] or String	Serializable	application/x-java-serialized-object	application/x-java-object	
JSON byte[] or String	Tuple	application/json (or none)	application/x-xd-tuple	
byte[]	String	any	text/plain, java.lang.String	will apply any Charset specified in the content-type header
String	byte[]	any	application/octet-stream	will apply any Charset specified in the content-type header

Caveats

Note that `inputType` and `outputType` parameters only apply to payloads that require type conversion. For example, if a module produces an XML string with `outputType=application/json`, the payload will not be converted from XML to JSON. This is because the payload at the module's output channel is already a `String` so no conversion will be applied at runtime.

Part II. Developing Modules and Extensions

19. Creating a Source Module

19.1 Introduction

As outlined in the [modules](#) document, Spring XD currently supports four types of modules: source, sink, and processor for stream processing and job for batch processing. This document walks through the creation of a custom source module.

The first module in a [stream](#) is always a source. Source modules are built with Spring Integration and are responsible for producing messages originating from an external data source on its *output* channel. These message can then be processed by the downstream modules in a stream. A source module is often fed data by a Spring Integration inbound channel adapter, configured with a poller.

Spring Integration provides a number of adapters out of the box to integrate with various transports and data stores, such as JMS, File, HTTP, Web Services, Mail, and more. Typically, it is straightforward to create a source module using an existing inbound channel adapter.

Here we walk through an example demonstrating how to create and register a source module using the [Spring Integration Feed Inbound Channel Adapter](#). The complete code for this example is in the [rss-feed-source](#) sample project.

19.2 Create the module Application Context file

Configure the inbound channel adapter using an [xml](#) bean definition file in the `config` resource directory:

```
<beans...>
<int-feed:inbound-channel-adapter id="xdFeed" channel="output" url="${url}" auto-startup="false" >
  <int:poller fixed-rate="${fixedRate}" max-messages-per-poll="${maxMessagesPerPoll}" />
</int-feed:inbound-channel-adapter>

<int:channel id="output"/>
</beans>
```

The adapter is configured to poll an RSS feed at a fixed rate (e.g., every 5 seconds). Note that `auto-startup` is set to `false`. This is a requirement for Spring XD modules. When a stream is deployed, the Spring XD runtime will create and start stream modules in reverse order to ensure that all modules are initialized before the source starts emitting messages. When an RSS Entry is retrieved, it will create a message with a `com.rometools.rome.feed.synd.SyndEntry` payload type and send it to a message channel called *output*. The name *output* is a Spring XD convention indicating the module's output channel. Any messages on the output channel will be consumed by the downstream processor or sink in a stream used by this module.

The module is configurable so that it may pull data from any feed URL, such as `http://feeds.bbci.co.uk/news/rss.xml`. Spring XD will automatically register a `PropertyPlaceholderConfigurer` in the module's application context. These properties correspond to module options defined for this module (discussed below). Users supply option values when creating a [stream](#) using the DSL.

Users must provide a `url` option value when creating a stream that uses this source. The polling rate and maximum number of entries retrieved for each poll are also configurable and for these properties we should provide reasonable default values. The module's [properties](#) file in the `config` resource

directory contains [Module Options Metadata](#) including a description, type, and optional default value for each property. The metadata supports features like auto-completion in the Spring XD shell and option validation:

```
options.url.description = the URL of the RSS feed
options.url.type = java.lang.String

options.fixedRate.description = the fixed rate polling interval specified in milliseconds
options.fixedRate.default = 5000
options.fixedRate.type = int

options.maxMessagesPerPoll.description = the maximum number of messages per poll
options.maxMessagesPerPoll.default = 100
options.maxMessagesPerPoll.type = int
```

Alternately, you can write a [POJO to define the metadata](#). Using a Java class provides better validation along with additional features and requires that the class be packaged as part of the module.

19.3 Create a Module Project

This section covers the setup of a standalone [project](#) containing the module configuration and some code for testing the module. This example uses Maven but Spring XD supports Gradle as well.

Take a look at the [pom](#) file for this example. You will see it declares `spring-xd-module-parent` as its parent and declares a dependency on `spring-integration-feed` which provides the inbound channel adapter. The parent pom provides everything else you need. We also need to configure repositories to access the parent pom and any other dependencies. The required [xml](#) file containing the bean definitions and [properties](#) file are located in `src/main/resources/config`. In this case, we have elected to use a custom transformer to convert the output of the feed inbound adapter to a JSON string.

```
<beans ...>
  <int-feed:inbound-channel-adapter id="xdFeed" channel="to.json" url="${url}" auto-startup="false">
    <int:poller fixed-rate="${fixedRate}" max-messages-per-poll="${maxMessagesPerPoll}" />
  </int-feed:inbound-channel-adapter>

  <int:transformer input-channel="to.json" output-channel="output">
    <bean class="com.acme.SyndEntryJsonTransformer"/>
  </int:transformer>

  <int:channel id="output"/>
</beans>
```

The project [README](#) contains a detailed explanation of why this transformer is needed, but such things are easily accomplished with Spring Integration.

Create a Spring Integration test

The first level of testing should ensure that the module's Application Context is loaded and that the message flow works as expected independent of Spring XD. In this case, we need to wrap the module application context in a test context that provides a property placeholder (the Spring XD runtime does this for you). In addition, it is convenient to override the module's output channel with a queue channel so that the test will block until a message is received from the feed.

Add the following [configuration](#) in the appropriate location under `src/test/resources/`:

```

<beans ...>

<context:property-placeholder properties-ref="props"/>
<util:properties id="props">
  <prop key="url">http://feeds.bbc1.co.uk/news/rss.xml</prop>
  <prop key="fixedRate">5000</prop>
  <prop key="maxMessagesPerPoll">100</prop>
</util:properties>

<import resource="classpath:config/spring-module.xml"/>

<!-- Override direct channel with a queue channel so the test will block until a message is received -->
<int:channel id="output">
  <int:queue/>
</int:channel>
</beans>

```

Next, create and run the [test](#):

```

package com.acme;

import ...

@RunWith(SpringJUnit4ClassRunner.class)
@ContextConfiguration
public class FeedConfigurationTest {
  @Autowired
  PollableChannel output;

  @Autowired
  ConfigurableApplicationContext applicationContext;

  @Test
  public void test() {
    applicationContext.start();
    Message message = output.receive(10000);
    assertNotNull(message);
    assertTrue(message.getPayload() instanceof String);
  }
}

```

The test will load an Application Context using our feed and test context files. It will fail if a item is not received on the output channel within 10 seconds.e

Create an in-container test

Now that you have verified that the module is basically correct, you can write a test to use it in a stream deployed to an embedded Spring XD container.

Note

See [test a module](#) for some important tips abouts regarding in-container testing.

The `spring-xd-module-parent` pom provides the necessary dependencies to write such a [test](#):

```

package com.acme;

import ...

public class FeedSourceModuleIntegrationTest {
    private static SingleNodeApplication application;

    private static int RECEIVE_TIMEOUT = 6000;

    /**
     * Start the single node container, binding random unused ports, etc. to not conflict with any other
     instances
     * running on this host. Configure the ModuleRegistry to include the project module.
     */
    @BeforeClass
    public static void setUp() {
        RandomConfigurationSupport randomConfigSupport = new RandomConfigurationSupport();
        application = new SingleNodeApplication().run();
        SingleNodeIntegrationTestSupport singleNodeIntegrationTestSupport = new
        SingleNodeIntegrationTestSupport(application);
        singleNodeIntegrationTestSupport.addModuleRegistry(new
        SingletonModuleRegistry(ModuleType.source, "feed"));
    }

    @Test
    public void test() {
        String url = "http://feeds.bbc.co.uk/news/rss.xml";
        SingleNodeProcessingChainConsumer chain = chainConsumer(application, "feedStream", String.format("feed
        --url='%s'", url));

        Object payload = chain.receivePayload(RECEIVE_TIMEOUT);
        assertTrue(payload instanceof String);

        chain.destroy();
    }
}

```

The above test configures an and starts embedded Spring XD runtime (`SingleNodeApplication`) to deploy a stream that uses the module under test.

The `SingleNodeProcessingChainConsumer` can test a stream that does not include a sink. The chain itself provides an in-memory sink to access the stream's output directly. In this case, we use the chain to test the source in isolation. The above test is equivalent to deploying following stream definition:

```
feed --url='http://feeds.bbc.co.uk/news/rss.xml' > queue:aNamedChannel
```

and the chain consumes messages on the named queue channel. At the end of each test method, the chain should be destroyed to destroy these internal resources and restore the initial state of the Spring XD container.

Note

The `spring-xd-module-parent` Maven pom includes a tasks to install a local message bus implementation under `lib` in the project root to enable a local transport provider for the embedded Spring XD container. It is necessary to run `maven process-resources` or a downstream goal (e.g., `compile`, `test`, `package`) once in order for this test to work correctly.

19.4 Install the Module

We have implemented and tested the module using Spring Integration directly and also by deploying the module to an embedded Spring XD container. Time to install the module to Spring XD!

The next step is to package the module as an uber-jar using maven:

```
$mvn package
```

This will build an uber-jar in `target/rss-feed-source-1.0.0.BUILD-SNAPSHOT.jar`. If you inspect the contents of this jar, you will see it includes the module configuration files, custom transformer class, and dependent jars. [Fire up the Spring XD runtime](#) if it is not already running and, using the Spring XD Shell, install the module as a source named `feed` using the `module upload` command:

```
xd:>module upload --file [path-to]/rss-source-feed/target/rss-source-feed-1.0.0.BUILD-SNAPSHOT.jar --
name feed --type source
```

Also See [registering a module](#) for more details.

19.5 Test the source module

Once Spring XD is running, create a stream to test it the module. This stream will write `SyndEntry` objects rendered as JSON to the Spring XD log:

```
xd:> stream create --name feedtest --definition "feed --url='http://feeds.bbci.co.uk/news/rss.xml' |
log" --deploy
```

You should start seeing messages like the following in the container log:

```
16:46:41,309 1.1.0.SNAP INFO xdbus.feedTest.0-1 sink.feedTest - {"uri":"http://
www.bbc.co.uk/sport/0/football/30700069","link":"http://www.bbc.co.uk/sport/0/
football/30700069","comments":null,"updatedAt":null,"title":"Gerrard to seal move
to LA Galaxy","description":{"type":"text/html","value":"Liverpool captain Steven
Gerrard is on the brink of finalising an 18-month deal to join MLS side Los Angeles
Galaxy."},"mode":null,"interface":"com.rometools.rome.feed.synd.SyndContent"},"links":[],"contents":
[],"modules":[{"uri":"http://purl.org/dc/
elements/1.1/","title":null,"creator":null,"subject":null,"description":null,"publisher":null,"contributors":
[],"date":1420580673000,"type":null,"format":null,"identifier":null,"source":null,"language":null,"relation":null,"coverage":
[],"types":[],"formats":[],"identifiers":
[],"interface":"com.rometools.rome.feed.module.DCModule","creators":[],"titles":
[],"descriptions":[],"publishers":[],"contributor":null,"dates":[1420580673000],"languages":
[],"relations":[],"coverages":[],"rightsList":[],"subjects":[]},"enclosures":
[],"authors":[],"contributors":[],"source":null,"wireEntry":null,"categories":
[],"interface":"com.rometools.rome.feed.synd.SyndEntry","titleEx":{"type":null,"value":"Gerrard to seal
move to LA
Galaxy"},"mode":null,"interface":"com.rometools.rome.feed.synd.SyndContent"},"publishedDate":1420580673000,"author":""}
```

20. Creating a Data Stream Processor

20.1 Introduction

This section covers how to create a processor module that uses stream processing libraries and `runtime.module`. Spring XD 1.1 provides integration with Project Reactor Stream, RxJava Observables, and Spark Streaming. Creating a data stream processor in XD allows you to use a functional programming model to filter, transform and aggregate data in a very concise and performant way. This section walks through implementing a custom processor module using each of these libraries.

20.2 Reactor Streams

[Project Reactor](#) provides a [Stream API](#) that is based on the [Reactive Streams specification](#). The specification was jointly developed by twenty people from a dozen companies (Pivotal included) and has the goal of creating a standard for asynchronous stream processing with non-blocking back pressure on the JVM.

To implement a Stream based processor module you need to implement the interface `org.springframework.xd.reactor.Processor`

```
public interface Processor<I, O> {
    /**
     * Process a stream of messages and return an output stream. The input
     * and output stream will be mapped onto receive/send operations on the message bus.
     *
     * @param inputStream Input stream the receives messages from the message bus
     * @return Output stream of messages sent to the message bus
     */
    Stream<O> process(Stream<I> inputStream);
}
```

Messages that are delivered on the Message Bus are accessed from the input Stream. The return value is the output Stream that is the result of applying various operations to the input stream. The content of the output Stream is sent to the message bus for consumption by other processors or sinks.

Examples of operations you can perform on the Stream are `map`, `flatMap`, `buffer`, `window`, and `reduce`. The parameterized data type can be a `org.springframework.messaging.Message`, `org.springframework.xd.tuple.Tuple`, `java.lang.Map` or any other POJO. The following example uses the `Tuple` object to compute the average value of a measurement from a sample size of 5.

```
import org.springframework.xd.reactor.Processor;
import org.springframework.xd.tuple.Tuple;
import reactor.rx.Stream;

import static com.acme.Math.avg;
import static org.springframework.xd.tuple.TupleBuilder.tuple;

public class MovingAverage implements Processor<Tuple, Tuple> {
    @Override
    public Stream<Tuple> process(Stream<Tuple> inputStream) {
        return inputStream.map(tuple -> tuple.getDouble("measurement"))
            .buffer(5)
            .map(data -> tuple().of("average", avg(data)));
    }
}
```

You can now create unit tests for the Processor module just as you would for any other Java class. The module application context file can be in XML or in Java using a `@Configuration` class. The XML version is shown below.

```
<beans xmlns:xsi="http://www.w3.org/2001/XMLSchema-instance"
  xmlns:int="http://www.springframework.org/schema/integration"
  xmlns="http://www.springframework.org/schema/beans"
  xsi:schemaLocation="http://www.springframework.org/schema/integration
    http://www.springframework.org/schema/integration/spring-integration.xsd
    http://www.springframework.org/schema/beans
    http://www.springframework.org/schema/beans/spring-beans.xsd">

  <bean id="messageProcessor" class="com.acme.MovingAverage"/>

  <!-- The following configuration uses the SyncDispatcherMessageHandler -->

  <int:channel id="input"/>

  <bean name="messageHandler" class="org.springframework.xd.reactor.SynchronousDispatcherMessageHandler">
    <constructor-arg ref="messageProcessor"/>
  </bean>

  <int:service-activator input-channel="input" ref="messageHandler"
    output-channel="output"/>

  <int:channel id="output"/>
</beans>
```

Examples of unit and integration testing a module are available in the [reactor sample project](#). The sample project also shows how you can [package](#) your module into a single jar and [upload](#) it to the admin server.

20.3 RxJava Streams

RxJava provides the [Observable API](#) that is based on the [Reactive Extensions .NET library](#).

To implement a Observable based XD processor module you need to implement the interface `org.springframework.xd.rxjava.Processor`

```
public interface Processor<I,O> {

  /**
   * Process a stream of messages and return an output stream. The input
   * and output stream will be mapped onto receive/send operations on the message bus.
   *
   * @param inputStream Input stream the receives messages from the message bus
   * @return Output stream of messages sent to the message bus
   */
  Observable<O> process(Observable<I> inputStream);
}
```

Messages that are delivered on the Message Bus are accessed from the Observable input stream. The return value is the Observable output stream that contains the results of applying various operation to the input stream. The content of the output stream is sent to the message bus for consumption by other processors or sinks.

Examples of operations you can perform on the Stream are `map`, `flatMap`, `buffer`, `window`, and `reduce`. The parameterized data type can be a `org.springframework.messaging.Message`, `org.springframework.xd.tuple.Tuple`, `java.lang.Map` or any other POJO.

When used in combination with Data Partitioning on the Message Bus, this allows you to create a streaming application where Stream state is calculated based on those partitions where necessary.

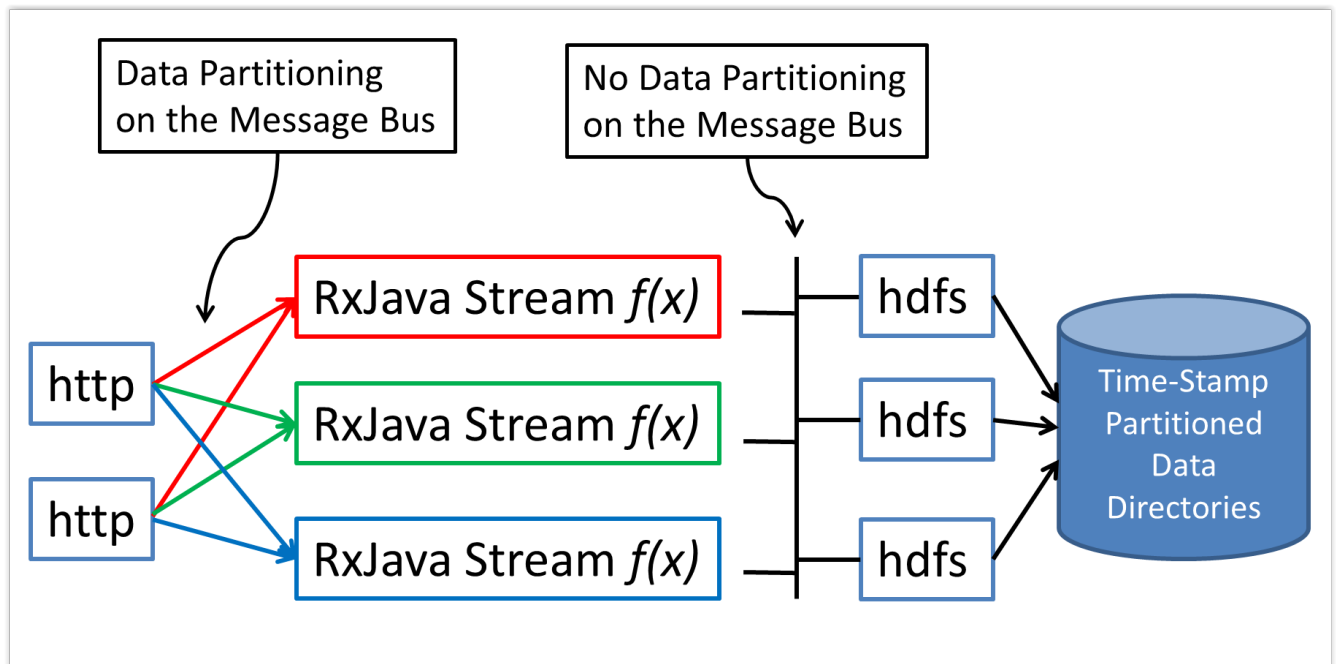

In this deployment the data that is sent to the RxJava processing modules from the HTTP sources is partitioned such that the *red* data always goes to the *red* stream processing module and so on for the other colors. The next hop of processing, where writing to HDFS occurs, does not require data partitioning, so the message load can be shared across the HDFS sink instances.

There can be as many layers of RxJava Stream processing as you require, allowing you to collocate specific functional operations as you see fit within a single JVM or to distribute across multiple JVMs.

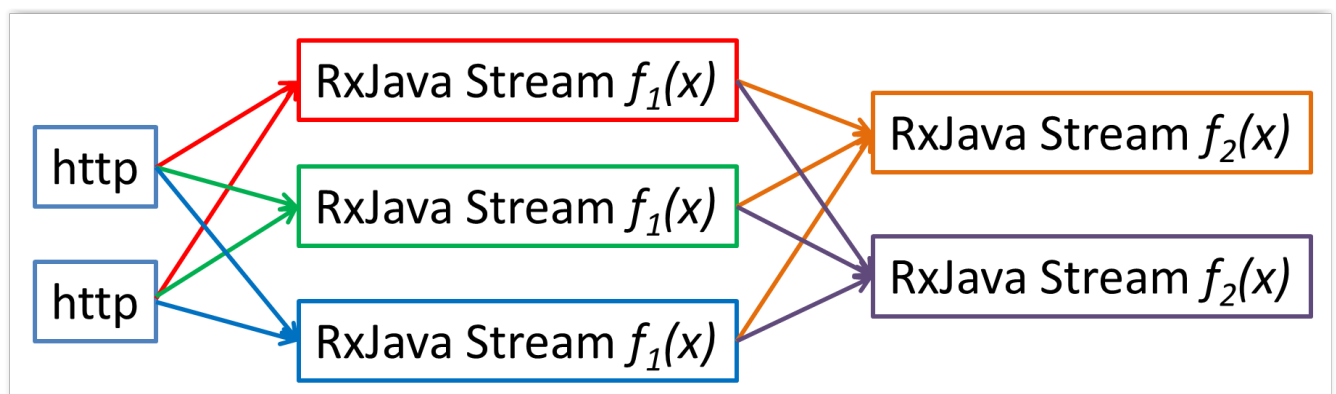

The following example uses the `Tuple` object to compute the average value of a measurement from a sample size of 5.

```

import org.springframework.xd.rxjava.Processor;
import org.springframework.xd.tuple.Tuple;
import rx.Observable;

import static com.acme.Math.avg;
import static org.springframework.xd.tuple.TupleBuilder.tuple;

public class MovingAverage implements Processor<Tuple, Tuple> {

    @Override
    public Observable<Tuple> process(Observable<Tuple> inputStream) {
        return inputStream.map(tuple -> tuple.getDouble("measurement"))
            .buffer(5)
            .map(data -> tuple().of("average", avg(data)));
    }
}

```

You can now create unit tests for the Processor module as you would for any other Java class. The module application context file can be in XML or in Java using a `@Configuration` class. The XML version is shown below.

```

<beans xmlns:xsi="http://www.w3.org/2001/XMLSchema-instance"
    xmlns:int="http://www.springframework.org/schema/integration"
    xmlns="http://www.springframework.org/schema/beans"
    xsi:schemaLocation="http://www.springframework.org/schema/integration
        http://www.springframework.org/schema/integration/spring-integration.xsd
        http://www.springframework.org/schema/beans
        http://www.springframework.org/schema/beans/spring-beans.xsd">

    <bean id="messageProcessor" class="com.acme.MovingAverage"/>

    <!-- Using a SubjectMessageHandler to share Observable state across threads -->

    <int:channel id="input"/>

    <bean name="messageHandler" class="org.springframework.xd.rxjava.SubjectMessageHandler">
        <constructor-arg ref="messageProcessor"/>
    </bean>

    <int:service-activator input-channel="input" ref="messageHandler"
        output-channel="output"/>

    <int:channel id="output"/>

</beans>

```

Examples of unit and integration testing a module are available in the [reactor sample project](#). The sample project also shows how you can [package](#) your module into a single jar and [upload](#) it to the admin server.

Scheduling

There are two `MessageHandler` implementations that you can choose from, `SubjectMessageHandler` and `MultipleSubjectMessageHandler`.

`SubjectMessageHandler` uses a single `SerializedSubject` to process messages that were received from the Message Bus. This subject, downcast to `Observable`, is what is passed into the `process` method. Using `SubjectMessageHandler` has the advantage that the state of the `Observable` input stream can be shared across all the Message Bus dispatcher threads that are invoking `onNext`. It has the disadvantage that the processing and consumption of the `Observable` output stream (that sends messages to the Message Bus) will execute serially on one of the dispatcher threads.

Note you can modify what thread the Observable output stream will use by calling `observeOn` before returning the output stream from your processor.

`MultipleSubjectMessageHandler` uses multiple `Subjects` to perform processing. A Spring Expression Language (SpEL) expression is used to map the incoming message to a specific `Subject` to use for processing. Using `MultipleSubjectMessageHandler` has the advantage that it can use all Message Bus dispatcher threads. It has the disadvantage in that each Observable input stream has its own state, which may not be desirable for certain types of aggregate calculations that should see all of the data. A common partition expression to use is `T(java.lang.Thread).currentThread().getId()` so that a `Subject` will be created per thread.

```
<bean name="messageHandler" class="org.springframework.xd.rxjava.MultipleSubjectMessageHandler">
  <constructor-arg ref="messageProcessor"/>
  <constructor-arg value="T(java.lang.Thread).currentThread().getId()"/>
</bean>
```

The satisfies the contract to have single threaded access to a `Subject`. Another interesting partition expression to use in the case of the Kafka Message Bus is `header['kafka_partition_id']`. This will create a `Subject` per Kafka partition that represents an ordered sequence of events. The XD Kafka Message Bus statically maps partitions to dispatcher threads to there is only single threaded access to a `Subject`.

20.4 Spark streaming

Spring XD integrates with Spark streaming so that the streaming data computation logic can be run on a **spark cluster**. Spring XD runs the `Spark Driver` as an XD module (processor or sink) in the XD container while the `spark streaming receiver` and the data computation is done at the `Spark Cluster`.

This provides advantage over connecting to various streaming sources while running the computation logic on spark cluster. Running the spark driver on the XD container also provides automatic failover capabilities in case of driver failure.

With Spark Streaming, events are processed at the `micro batch level` via `DStreams`, which represent a continuous flow of partitioned `RDDs`. Setting up a Spark Streaming module within XD can be beneficial when adding streaming data computation logic for a `tapped XD stream`. While the primary stream processes events one at a time (through the regular XD modules), the tapped stream will become a `source` for the Spark Streaming module.

Lets discuss a real world scenario of data collection and doing some analytics on it.

```
stream create mainstream --definition "mqtt | filter1: <some filtering> | hdfs"
stream create sparkstream1 --definition "tap:mainstream:filter1 > spark-streaming-processor-module1 |
<some XD sink>"
stream create sparkstream2 --definition "tap:mainstream:filter1 > spark-streaming-processor-module2 |
spark-streaming-sinkmodule1"
stream create sparkstream3 --definition "tap:mainstream:filter1 > spark-streaming-sinkmodule2"
```

In the above set of streams, consider a primary stream that collects data `one at a time` from various sensors and stores that `raw data` into HDFS, after only some basic filtering. At the same time, there are a few other streams that perform analytics on the data being collected at `micro-batch level`. Here, the tapped stream's source can be `reliable` or `durable` based on the `messagebus` implementation, and this data is processed (at the `micro batch level`) by the Spark Streaming module. This allows the developer to choose the stream data processing based on the use case.

Writing a spark streaming module

Spring XD provides **Java** and **Scala** based interfaces which expose a `process` method that the spark streaming developer would implement. This method processes the input `DStream` received by the spark streaming `receiver`. In case of XD processor module this method would return an output `DStream`. In case of XD sink module, it would write the computed data into file system, HDFS etc., (for example `saveAsTextFiles()`, `saveAsHadoopFiles()` using Spark APIs).

For **Java** based implementation, the interface `org.springframework.xd.spark.streaming.java.Processor` is defined

```
public interface Processor<I extends JavaDStreamLike, O extends JavaDStreamLike> extends
SparkStreamingSupport {

/**
 * Processes the input DStream and optionally returns an output DStream.
 *
 * @param input the input DStream
 * @return output DStream (optional, may be null)
 */
O process(I input);
}
```

It is recommended to write the implementation in [Java 8](#).

For **Scala** based implementation, the trait `org.springframework.xd.spark.streaming.scala.Processor` is defined

```
trait Processor[I, O] extends SparkStreamingSupport {

/**
 * Processes the input DStream and optionally returns an output DStream.
 *
 * @param input the input DStream from the receiver
 * @return output DStream (optional, may be null)
 */
def process(input: ReceiverInputDStream[I]): DStream[O]
}
```

When creating an XD processor/sink module, developer would implement this interface and make the module archive (along with its dependencies) available in the modules registry.

To set the Spark configuration properties when developing spark streaming module, the developer can use `org.springframework.xd.spark.streaming.SparkConfig` annotation on the method that returns type `java.util.Properties`.

To add default spark streaming command line options for the spark streaming module and to let XD admin know this is spark streaming module, following entry should be added in module registry module config properties (for example: `modules/processor/spark-wordcount/config/spark-wordcount.properties`):

```
options_class=org.springframework.xd.spark.streaming.DefaultSparkStreamingModuleOptionsMetadata
```

Developer can extend this to provide more custom command line options. By default, the following module options are supported for the spark streaming module:

- `batchInterval` (the time interval in millis for batching the stream events)
- `storageLevel` (the streaming data persistence storage level)

Note

If you are using **Java7** to run Spring XD, then make sure to set the **JAVA_OPTS** to increase `-XX:MaxPermSize` to avoid PermGen issue on the XD container where the spark driver would be running.

How this works

When a spark streaming processor (a processor or a sink) that implements `Processor` interface above is deployed, the `SparkDriver` sets up the streaming context and runs as an XD module inside the **XD container**.

This sets up Spark streaming receiver (in case of processor and sink) in spark cluster that connects to XD upstream module's output channel in the message bus. This `MessageBusReceiver` makes the incoming messages available for the computation in spark cluster as DStreams. If the streaming module is of XD processor type then the computed messages are pushed to the downstream module by `MessageBusSender`. The `MessageBusSender` binds to the downstream module's input channel which subsequently connects to any of the XD processor or sink modules.

It is important to note that the `MessageBusReceiver`, streaming processor computation and the `MessageBusSender` run on **Spark cluster**.

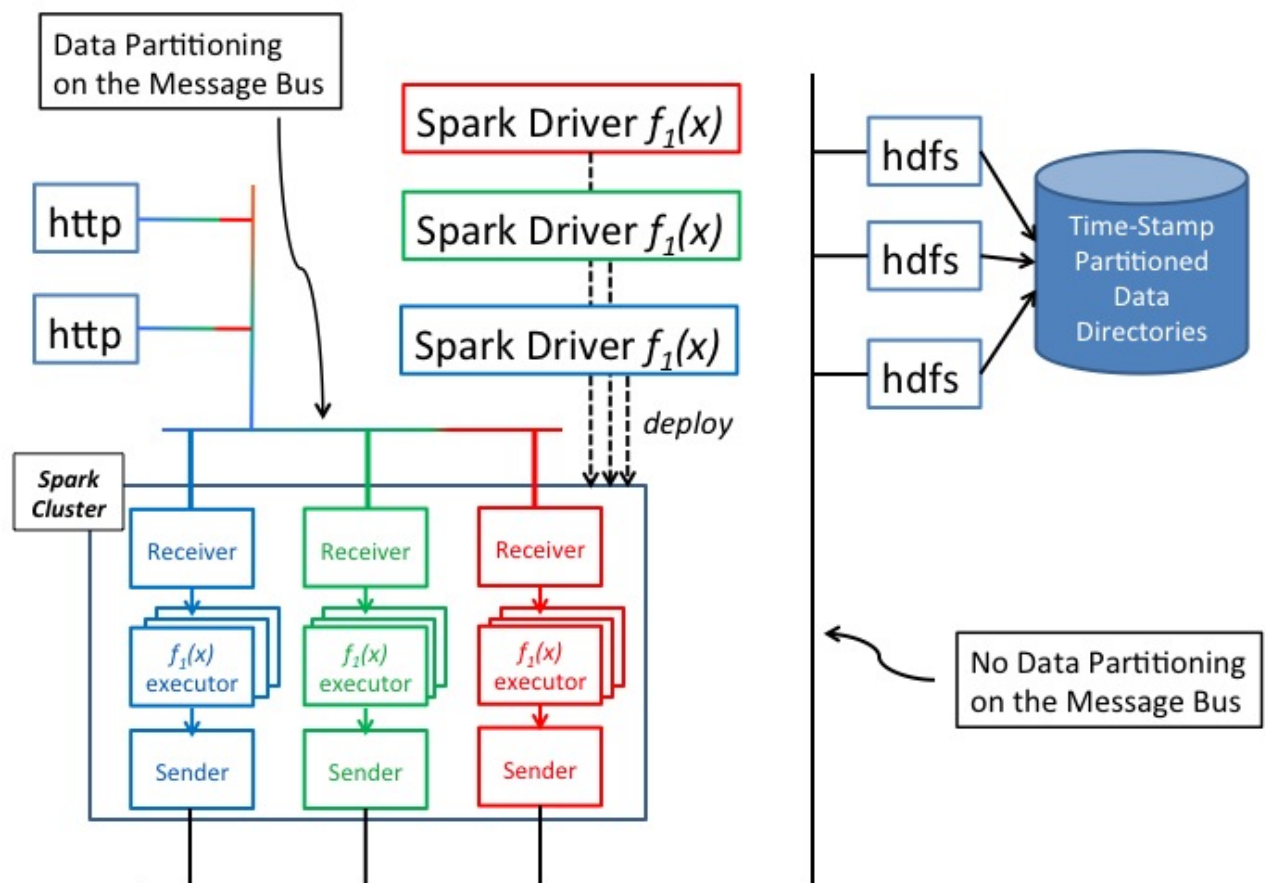

Data loss and recovery

The current implementation of the spark streaming supports automatic failover capability on spark driver failure by re-deploying the spark streaming module but the streaming receiver

(MessageBus receiver) implementation isn't reliable yet. (There could be data loss in case of receiver worker node failure). In the upcoming release, we will have a reliable receiver [implementation](#).

Module Type Conversion

Spark streaming modules avail the out of the box module type conversion support from Spring XD. A spark streaming processor module can specify `inputType` and `outputType` while a spark streaming sink module can specify `inputType` to denote the `contentType` of the incoming/outgoing messages before they get ingested into/written out of spark streaming module.

```
stream create mainstream --definition "mqtt | filter1: <some filtering> | hdfs"
stream create sparkstream1 --definition "tap:mainstream:filter1 > spark-streaming-processor-module1 --
inputType=application/json --outputType=application/x-td-tuple | <some XD sink>"
stream create sparkstream2 --definition "tap:mainstream:filter1 > spark-streaming-processor-module2 |
spark-streaming-sinkmodule1"
stream create sparkstream3 --definition "tap:mainstream:filter1 > spark-streaming-sinkmodule2 --
inputType=text/plain"
```

For info on module type conversion, please refer [here](#)

XD processor module examples

Java based implementation

```

import java.util.Arrays;
import java.util.Properties;

import org.apache.spark.api.java.function.FlatMapFunction;
import org.apache.spark.api.java.function.Function2;
import org.apache.spark.api.java.function.PairFunction;
import org.apache.spark.streaming.api.java.JavaDStream;
import org.apache.spark.streaming.api.java.JavaPairDStream;

import org.springframework.xd.spark.streaming.SparkConfig;
import org.springframework.xd.spark.streaming.java.Processor;

import scala.Tuple2;

@SuppressWarnings({ "serial" })
public class WordCount implements Processor<JavaDStream<String>, JavaPairDStream<String, Integer>> {

    @Override
    public JavaPairDStream<String, Integer> process(JavaDStream<String> input) {
        JavaDStream<String> words = input.flatMap(new FlatMapFunction<String, String>() {

            @Override
            public Iterable<String> call(String x) {
                return Arrays.asList(x.split(" "));
            }
        });
        JavaPairDStream<String, Integer> wordCounts = words.mapToPair(new PairFunction<String, String,
        Integer>() {

            @Override
            public Tuple2<String, Integer> call(String s) {
                return new Tuple2<String, Integer>(s, 1);
            }
        }).reduceByKey(new Function2<Integer, Integer, Integer>() {

            @Override
            public Integer call(Integer i1, Integer i2) {
                return i1 + i2;
            }
        });
        return wordCounts;
    }

    @SparkConfig
    public Properties getSparkConfigProperties() {
        Properties props = new Properties();
        props.setProperty(SPARK_MASTER_URL_PROP, "local[4]");
        return props;
    }
}

```

Scala based implementation

```
import java.util.Properties

import org.apache.spark.streaming.StreamingContext._
import org.apache.spark.streaming.dstream.{DStream, ReceiverInputDStream}
import org.springframework.xd.spark.streaming.SparkConfig
import org.springframework.xd.spark.streaming.scala.Processor

class WordCount extends Processor[String, (String, Int)] {

  def process(input: ReceiverInputDStream[String]): DStream[(String, Int)] = {
    val words = input.flatMap(_.split(" "))
    val pairs = words.map(word => (word, 1))
    val wordCounts = pairs.reduceByKey(_ + _)
    wordCounts
  }

  @SparkConfig
  def properties : Properties = {
    val props = new Properties()
    props.setProperty("spark.master", "local[4]")
    props
  }
}
```

21. XD sink module example

Java based implementation

```

import java.io.BufferedWriter;
import java.io.File;
import java.io.FileWriter;
import java.io.IOException;
import java.util.Iterator;
import java.util.Properties;

import org.apache.spark.api.java.JavaRDD;
import org.apache.spark.api.java.function.Function;
import org.apache.spark.api.java.function.VoidFunction;
import org.apache.spark.streaming.api.java.JavaDStream;

import org.springframework.xd.spark.streaming.SparkConfig;
import org.springframework.xd.spark.streaming.java.Processor;

@SuppressWarnings({ "serial" })
public class FileLogger implements Processor<JavaDStream<String>, JavaDStream<String>> {

    private File file;

    public void setPath(String filePath) {
        file = new File(filePath);
        if (!file.exists()) {
            try {
                file.createNewFile();
            }
            catch (IOException ioe) {
                throw new RuntimeException(ioe);
            }
        }
    }

    @SparkConfig
    public Properties getSparkConfigProperties() {
        Properties props = new Properties();
        props.setProperty("spark.master", "local[4]");
        return props;
    }

    @Override
    public JavaDStream<String> process(JavaDStream<String> input) {
        input.foreachRDD(new Function<JavaRDD<String>, Void>() {

            @Override
            public Void call(JavaRDD<String> rdd) {
                rdd.foreachPartition(new VoidFunction<Iterator<String>>() {

                    @Override
                    public void call(Iterator<String> items) throws Exception {
                        FileWriter fw;
                        BufferedWriter bw = null;
                        try {
                            fw = new FileWriter(file.getAbsolutePath());
                            bw = new BufferedWriter(fw);
                            while (items.hasNext()) {
                                bw.append(items.next() + System.lineSeparator());
                            }
                        }
                        catch (IOException ioe) {
                            throw new RuntimeException(ioe);
                        }
                        finally {
                            if (bw != null) {
                                bw.close();
                            }
                        }
                    }
                });
            }
        });
        return null;
    }
}

```

Scala based implementation

```
import java.io.{BufferedWriter, File, FileWriter, IOException}
import java.util.Properties

import org.apache.spark.streaming.dstream.{DStream, ReceiverInputDStream}
import org.springframework.xd.spark.streaming.SparkConfig
import org.springframework.xd.spark.streaming.scala.Processor

class FileLogger extends Processor[String, String] {

  var file: File = null

  def setPath(filePath: String) {
    file = new File(filePath)
    if (!file.exists) {
      try {
        file.createNewFile
      }
      catch {
        case ioe: IOException => {
          throw new RuntimeException(ioe)
        }
      }
    }
  }

  @SparkConfig def getSparkConfigProperties: Properties = {
    val props: Properties = new Properties
    props.setProperty("spark.master", "local[4]")
    return props
  }

  def process(input: ReceiverInputDStream[String]): DStream[String] = {
    input.foreachRDD(rdd => {
      rdd.foreachPartition(partition => {
        var fw: FileWriter = null
        var bw: BufferedWriter = null
        try {
          fw = new FileWriter(file.getAbsoluteFile)
          bw = new BufferedWriter(fw)
          while (partition.hasNext) {
            bw.append(partition.next.toString + System.lineSeparator)
          }
        }
        catch {
          case ioe: IOException => {
            throw new RuntimeException(ioe)
          }
        }
        finally {
          if (bw != null) {
            bw.close
          }
        }
      })
    })
    null
  }
}
```

Checkout some [examples](#), [module configurations](#) and [tests](#)

22. Creating a Processor Module

22.1 Introduction

As outlined in the [modules](#) document, Spring XD currently supports four types of modules: source, sink, and processor for stream processing and job for batch processing. This document walks through implementing a custom processor module.

One or more processors can be included in a [stream](#) definition to modify the data as it passes on its way from the source to the sink. The [architecture](#) section covers the basics of stream processing. Processor modules provided out of the box are covered in the [processors](#) section.

Here we'll look at how to create a simple processor module from scratch. This module will extract the `text` field from input messages from from a `twittersearch` source. The steps are essentially the same regardless of the module's functionality. Note that Spring XD can perform this type of transformation without requiring a custom module. Rather than using the built-in functionality, we will implement a custom processor and wire it up with Spring Integration. The complete code for this example is [here](#).

22.2 Write the Transformer Code

The tweet messages from `twittersearch` contain quite a lot of data (id, author, time, hash tags, and so on). The transformer we'll write extracts the text of each tweet and outputs this as a string. The output messages from the `twittersearch` source are also strings, rendering the tweet data as JSON. We first load this into a map using Jackson library code, then extract the `text` field from the map.

```
package my.custom.transformer;

import java.io.IOException;
import java.util.Map;

import org.codehaus.jackson.map.ObjectMapper;
import org.codehaus.jackson.type.TypeReference;
import org.springframework.integration.transformer.MessageTransformationException;

public class TweetTransformer {
    private ObjectMapper mapper = new ObjectMapper();

    public String transform(String payload) {
        try {
            Map<String, Object> tweet = mapper.readValue(payload, new TypeReference<Map<String, Object>>()
            {});
            return tweet.get("text").toString();
        } catch (IOException e) {
            throw new MessageTransformationException("Unable to transform tweet: " + e.getMessage(), e);
        }
    }
}
```

22.3 Create the module Application Context File

Create the following file as `spring-module.xml` in the `config` resource directory:

```
<?xml version="1.0" encoding="UTF-8"?>

<beans:beans xmlns="http://www.springframework.org/schema/integration"
  xmlns:xsi="http://www.w3.org/2001/XMLSchema-instance"
  xmlns:beans="http://www.springframework.org/schema/beans"
  xsi:schemaLocation="http://www.springframework.org/schema/beans
    http://www.springframework.org/schema/beans/spring-beans.xsd
    http://www.springframework.org/schema/integration
    http://www.springframework.org/schema/integration/spring-integration.xsd">
  <channel id="input"/>

  <transformer input-channel="input" output-channel="output">
    <beans:bean class="my.custom.transformer.TweetTransformer" />
  </transformer>

  <channel id="output"/>
</beans:beans>
```

Alternately, you can create the application context using an `@Configuration` class. In the example below, we've combined the configuration and the transformer into a single Java file for simplicity. Note that `TweetTransformer` now includes Spring Integration annotations:

```

package my.custom.transformer;

import java.io.IOException;
import java.util.Map;

import my.custom.transformer.TweetTransformer;
import org.codehaus.jackson.map.ObjectMapper;
import org.codehaus.jackson.type.TypeReference;

import org.springframework.beans.factory.annotation.Autowired;
import org.springframework.context.annotation.Bean;
import org.springframework.context.annotation.Configuration;
import org.springframework.integration.annotation.MessageEndpoint;
import org.springframework.integration.annotation.Transformer;
import org.springframework.integration.channel.DirectChannel;
import org.springframework.integration.config.EnableIntegration;
import org.springframework.integration.transformer.MessageTransformationException;
import org.springframework.messaging.MessageChannel;

@Configuration
@EnableIntegration
public class ModuleConfiguration {
    @Autowired
    TweetTransformer transformer;

    @Bean
    public MessageChannel input() {
        return new DirectChannel();
    }

    @Bean
    MessageChannel output() {
        return new DirectChannel();
    }
}

@MessageEndpoint
class TweetTransformer {
    private ObjectMapper mapper = new ObjectMapper();

    @Transformer(inputChannel = "input", outputChannel = "output")
    public String transform(String payload) {
        try {
            Map<String, Object> tweet = mapper.readValue(payload, new TypeReference<Map<String, Object>>() {
            });
            return tweet.get("text").toString();
        }
        catch (IOException e) {
            throw new MessageTransformationException("Unable to transform tweet: " + e.getMessage(), e);
        }
    }
}

```

To use `@Configuration`, you must also tell Spring which packages to scan in the module's properties file `spring-module.properties`:

```
base_packages=my.custom.transformer
```

22.4 Write a Test

Writing a test to deploy the module in an embedded single node container requires the `spring-xd-dirt` and `spring-xd-test` libraries and a few other things. See the project [pom](#) or the [gradle](#) build script for details. The following code snippets are from [TweetTransformerIntegrationTest](#)

Note

See [test a module](#) for some important tips abouts regarding in-container testing.

First we start the `SingleNodeApplication` and register the module under test by adding a `SingletonModuleRegistry` providing the module name and type. This looks in the root classpath by default, so will find the module configuration in [src/main/resources/config](#). `SingleNodeIntegrationTestSupport` provides programmatic access to major beans in the Admin and Container application contexts, as well as the contexts themselves.

```
/**
 * Unit tests a module deployed to an XD single node container.
 */
public class TweetTransformerIntegrationTest {

    private static SingleNodeApplication application;

    private static int RECEIVE_TIMEOUT = 5000;

    private static String moduleName = "tweet-transformer";

    /**
     * Start the single node container, binding random unused ports, etc. to not conflict with any other
     instances
     * running on this host. Configure the ModuleRegistry to include the project module.
     */
    @BeforeClass
    public static void setUp() {
        RandomConfigurationSupport randomConfigSupport = new RandomConfigurationSupport();
        application = new SingleNodeApplication().run();
        SingleNodeIntegrationTestSupport singleNodeIntegrationTestSupport = new
SingleNodeIntegrationTestSupport
        (application);
        singleNodeIntegrationTestSupport.addModuleRegistry(new SingletonModuleRegistry(ModuleType.processor,
moduleName));
    }
}
```

To implement this test, we will use the `SingleNodeProcessingChain` test fixture. The chain is a partial stream definition, represented as Spring XD DSL, which may be a single module, a chain of processors separated by `|`. In this case we are testing a single module. The chain binds local message handlers that act as source and sink to complete the stream. Thus we can deploy the stream and send messages directly to the source and receive messages directly from the sink:

We could, in theory, test against the actual `twittersearch` source, but this is not advised because it would depend on connecting to Twitter, providing credentials, etc. So we will save that for when the module is actually installed to the target Spring XD runtime. Instead, we can simply send a message with a sample tweet and verify that we get the content of the text property as output, as expected.

```

/**
 * This test creates a stream with the module under test, or in general a "chain" of processors. The
 * SingleNodeProcessingChain is a test fixture that allows the test to send and receive messages to
 * verify each
 * message is processed as expected.
 */
@Test
public void test() {
    String streamName = "tweetTest";
    String tweet = "..."; //JSON omitted here for clarity

    String processingChainUnderTest = moduleName;

    SingleNodeProcessingChain chain = chain(application, streamName, processingChainUnderTest);

    chain.sendPayload(tweet);

    String result = (String) chain.receivePayload(RECEIVE_TIMEOUT);

    assertEquals("Aggressive Ponytail #freebandnames", result);

    //Unbind the source and sink channels from the message bus
    chain.destroy();
}

```

22.5 Register the Module

Since the module requires no external dependencies in this case, we can build the project as a simple jar file and install it using the `module upload` shell command:

```

xd:>module upload --file [path-to]/tweet-transformer-1.0.0.BUILD-SNAPSHOT.jar --name tweet-transformer
--type processor
Successfully uploaded module 'processor:tweet-transformer'

```

If you make changes and need to re-install, you must first delete the existing module:

```

xd:>module delete processor:tweet-transformer

```

Note

A simple jar file works in this case because the module requires no additional library dependencies since the Spring XD class path already includes Jackson and Spring Integration. See [Module Packaging](#) for more details.

22.6 Test the custom module in the Spring XD runtime:

Start the Spring XD runtime and try creating a stream to test your processor:

```

xd:> stream create --name javatweets --definition "twittersearch --query=java --consumerKey=<your_key>
--consumerSecret=<your_secret> | tweet-transformer | file" --deploy

```

If you haven't already used `twittersearch`, read the [sources](#) section for more details. This command should stream tweets to the file `/tmp/xd/output/javatweets` but, unlike the normal `twittersearch` output, you should just see the text of the tweet rather than the full JSON document.

Also see [si-dsl-module example](#) for a more complex example of a processor module.

23. Creating a Sink Module

23.1 Introduction

As outlined in the [modules](#) document, Spring XD currently supports four types of modules: source, sink, and processor for stream processing and job for batch processing. This document walks through implementing a custom sink module.

The last module in a [stream](#) is always a sink. A sink module is built with Spring Integration to consume messages on its *input* channel and send them to an external resource to terminate the stream.

Spring Integration provides a number of outbound channel adapters to integrate with various transports such as TCP, AMQP, JMS, Kafka, HTTP, web services, mail, or data stores such as file, Redis, MongoDB, JDBC, Splunk, Gemfire, and more. It is straightforward to create a sink module using an existing outbound channel adapter. Such outbound channel adapters are typically used to integrate streams with external data stores or legacy systems. Alternately, you may need to invoke a third party Java API to provide data to an external system. In this case, the sink can easily invoke a Java method using a [Service Activator](#).

Here, we will demonstrate step-by-step how to create and install a sink module using the Spring Integration [Redis Store Outbound Channel Adapter](#). The complete code for this example is [redis-store-sink](#) sample project.

23.2 Create the module Application Context

Configure the outbound channel adapter in an [xml bean definition](#) file under the `config` resource directory:

```
<beans ...>

  <int:channel id="input" />

  <int-redis:store-outbound-channel-adapter
    id="redisListAdapter" collection-type="LIST" channel="input" key="${collection}" auto-startup="false"/
  >

  <beans:bean id="redisConnectionFactory"
    class="org.springframework.data.redis.connection.jedis.JedisConnectionFactory">
    <beans:property name="hostName" value="${host}" />
    <beans:property name="port" value="${port}" />
  </beans:bean>

</beans>
```

The adapter, as required by Spring XD, is configured as an endpoint on a channel named *input*. When a message is consumed, the Redis Store outbound channel adapter will write the payload to a Redis list with a key given by the `${collection}` property. By default, the Redis Store outbound channel adapter uses a bean named *redisConnectionFactory* to connect to the Redis server. Here the connection factory is configured with property placeholders `${host}`, `${port}` which will be provided as module options in stream definitions that use this sink. Note that `auto-startup` is set to `false`. This is a requirement for Spring XD modules. When a stream is deployed, the Spring XD runtime will create and start the modules in the correct order to ensure that everything is initialized before the stream starts processing messages.

Note

By default, the adapter uses a *StringRedisTemplate*. Therefore, this module will store all payloads directly as Strings. You may configure a *RedisTemplate* with a different value Serializer to serialize other data types, such as Java objects, to the Redis collection.

Spring XD will automatically register a PropertyPlaceholderConfigurer to your application context, so there is no need to declare one here. These properties correspond to module options defined for this module (discussed below). Users supply option values when creating a [stream](#) using the DSL.

The module's [properties](#) file in the `config` resource directory contains [Module Options Metadata](#) including a description, type, and optional default value for each property. The metadata supports features like auto-completion in the Spring XD shell and option validation:

```
options.collection.description = the name of the list
options.collection.default= ${xd.stream.name}
options.collection.type = java.lang.String
#
options.host.description = the host name for the Redis store
options.host.default= localhost
options.host.type = java.lang.String
#
options.port.description = the port for the Redis store
options.port.default= 6379
options.port.type = java.lang.Integer
```

Note that the *collection* defaults to the stream name, referencing a common property provided by Spring XD.

Alternately, you can write a [POJO to define the metadata](#). Using a Java class provides better validation along with additional features and requires that the class be packaged as part of the module.

23.3 Create a module project

This section covers creating the module as a standalone [project](#) containing some code to test the module. This example uses Maven but Spring XD supports Gradle as well

Take a look at the [pom](#) file for this example. You will see it declares `spring-xd-module-parent` as its parent and declares a dependency on `spring-integration-redis` which provides the outbound channel adapter. The parent pom provides everything else you need. We also need to configure repositories to access the parent pom and any other dependencies. The [xml](#) file containing the bean definitions and the [properties](#) file are located in `src\main\resources\config`.

Create the Spring integration test

The main objective of the test is to ensure that messages are stored in a Redis list once the module's Application Context is loaded. In order to test the module stand-alone, we need to enhance the module context with property values and a *RedisTemplate* to retrieve the stored messages.

Add the following [src/test/resources/org/springframework/xd/samples/RedisStoreSinkTest-context.xml](#):

```

<beans...>

<context:property-placeholder properties-ref="props"/>

<util:properties id="props">
  <prop key="collection">mycollection</prop>
  <prop key="host">localhost</prop>
  <prop key="port">6379</prop>
</util:properties>

<import resource="classpath:config/spring-module.xml"/>

<bean id="redisTemplate" class="org.springframework.data.redis.core.StringRedisTemplate">
  <property name="connectionFactory" ref="redisConnectionFactory"/>
</bean>
</beans>

```

Next, create and run the [RedisStoreSinkTest](#):

```

package org.springframework.xd.samples;

import ...

@RunWith(SpringJUnit4ClassRunner.class)
@ContextConfiguration
public class RedisStoreSinkTest {

  @Autowired
  ConfigurableApplicationContext applicationContext;

  @Autowired
  MessageChannel input;

  @Autowired
  RedisTemplate<String,String> redisTemplate;

  @Test
  public void test() {
    applicationContext.start();
    input.send(new GenericMessage<String>("hello"));
    assertEquals("hello", redisTemplate.boundListOps("mycollection").leftPop(5, TimeUnit.SECONDS));
  }

  @After
  public void cleanup() {
    redisTemplate.delete("mycollection");
  }
}

```

The test will load the module application context using our test context and send a message to the module's *input* channel. It will fail if the input payload "hello" is not added to the Redis list within 5 seconds.

Run the test

The test requires a running Redis server. See [Getting Started](#) for information on installing and starting Redis.

Test the Module Options

Another test you may want to include is one to verify the module options metadata, as defined in *spring-module.properties*. Here is an example [ModuleOptionsTest](#) that uses Spring XD's [DefaultModuleOptionsMetadataResolver](#)

```

package org.springframework.xd.samples;

import ...

/**
 * Tests expected module properties are present.
 */
public class ModuleOptionsTest {

    @Test
    public void testModuleOptions() {
        ModuleOptionsMetadataResolver moduleOptionsMetadataResolver = new
        DefaultModuleOptionsMetadataResolver();
        String resource = "classpath:/";
        ModuleDefinition definition = ModuleDefinitions.simple("redis-store", sink, resource);
        ModuleOptionsMetadata metadata = moduleOptionsMetadataResolver.resolve(definition);

        assertThat(
            metadata,
            containsInAnyOrder(moduleOptionNamed("collection"), moduleOptionNamed("host"),
                moduleOptionNamed("port")));

        for (ModuleOption moduleOption : metadata) {
            if (moduleOption.getName().equals("collection")) {
                assertEquals("${xd.stream.name}", moduleOption.getDefaultValue());
            }
            if (moduleOption.getName().equals("port")) {
                assertEquals("6379", moduleOption.getDefaultValue());
            }
            if (moduleOption.getName().equals("host")) {
                assertEquals("localhost", moduleOption.getDefaultValue());
            }
        }
    }

    public static Matcher<ModuleOption> moduleOptionNamed(String name) {
        return hasProperty("name", equalTo(name));
    }
}

```

23.4 Install the module

The next step is to package the module as an uber-jar using maven:

```
$mvn package
```

This will build an uber-jar in `target/redis-store-sink-1.0.0.BUILD-SNAPSHOT.jar`. If you inspect the contents of this jar, you will see it includes the module configuration files and dependent jars (spring-integration-redis in this case). [Fire up the Spring XD runtime](#) if it is not already running and, using the Spring XD Shell, install the module as a sink named `redis-store` using the `module upload` command:

```
xd:>module upload --file [path-to]/redis-store-sink/target/redis-store-sink-1.0.0.BUILD-SNAPSHOT.jar --
name redis-store --type sink
```

See [registering a module](#) for more details.

23.5 Test the module

Once the XD server is running, create a stream to test your new module. This stream will write tweets containing the word "java" to Redis as a JSON string:

```
xd:> stream create --name javasearch --definition "twittersearch --consumerKey=<your_key> --
consumerSecret=<your_secret> --query=java | redis-store --collection=javatweets" --deploy
```

Note that you need to have a consumer key and secret to use the `twittersearch` module. See the description in the [sources](#) section for more information.

Fire up the `redis-cli` and verify that tweets are being stored:

```
$ redis-cli
redis 127.0.0.1:6379> lrange javatweets 0 -1
1) "{\"id\":342386150738120704,\"text\": \"Now Hiring: Senior Java Developer\", \"createdAt\":1370466194000,\"fromUser\": \"jencompgeek\",...}\""
```

If you prefer a simpler test, you can create a stream using the `http` source and manually post data to it:

```
xd:> stream create --name redisTest --definition "http | redis-store" --deploy
xd:> http post --target http://localhost:9000 --data hello
```

```
redis 127.0.0.1:6379> lrange redisTest 0 -1
1) "hello"
```

24. Creating a Job Module

24.1 Introduction

As outlined in the [modules](#) document, XD currently supports four types of modules: source, sink, and processor for stream processing and job for batch processing. This document walks through creation of a simple job module.

24.2 Developing your Job

The Job definitions provided as part of the Spring XD distribution as well as those included in the [Spring XD Samples](#) repository can be used as a basis for building your own custom Jobs. The development of a Job largely follows the development of a Spring Batch job, for which there are several references.

- [Spring Batch home page](#)
- [Spring Batch In Action - Manning](#)
- [Pro Spring Batch - APress](#)

For help developing Job steps specific to Hadoop, e.g. HDFS, Pig, Hive, the [Spring XD Samples](#) is useful as well as the following resources

- [Spring for Apache Hadoop home page](#)
- [Spring Data - O'Reilly - Chapter 13](#)

24.3 Creating a Simple Job

First we'll look at how to create a job module from scratch. The complete working example is [here](#).

Create a Module Project

This section covers the setup of a standalone [project](#) containing the module configuration and custom code. This example uses Maven but Spring XD supports Gradle as well.

Take a look at the [pom](#) file for this example. You will see it declares `spring-xd-module-parent` as its parent. The parent pom provides support for building and packaging Spring XD modules, including spring-batch libraries. We also need to configure repositories to access the parent pom and its dependencies.

First create a java project for your module, named *batch-simple* in your favorite IDE.

Create the Spring Batch Job Definition

Create a The [job definition](#) file in `src\main\resources\config`. In this case, we use a custom [Tasklet](#). In this example there is only one step and it simply prints out the job parameters.

```
<?xml version="1.0" encoding="UTF-8"?>
<beans ...>

  <batch:job id="job">
    <batch:step id="helloSpringXDStep">
      <batch:tasklet ref="helloSpringXDTasklet" />
    </batch:step>
  </batch:job>

  <bean id="helloSpringXDTasklet"
    class="org.springframework.springxd.samples.batch.HelloSpringXDTasklet" />

</beans>
```

Write the Tasklet

Write a [HelloSpringXDTasklet](#) java class that implements [Tasklet](#). This will retrieve the job parameters and print them to `stdout`.

```

package org.springframework.springxd.samples.batch;

import ...

public class HelloSpringXDTasklet implements Tasklet, StepExecutionListener {

    private volatile AtomicInteger counter = new AtomicInteger(0);

    public HelloSpringXDTasklet() {
        super();
    }

    public RepeatStatus execute(StepContribution contribution,
        ChunkContext chunkContext) throws Exception {

        final JobParameters jobParameters =
            chunkContext.getStepContext().getStepExecution().getJobParameters();
        final ExecutionContext stepExecutionContext =
            chunkContext.getStepContext().getStepExecution().getExecutionContext();

        System.out.println("Hello Spring XD!");

        if (jobParameters != null && !jobParameters.isEmpty()) {

            final Set<Entry<String, JobParameter>> parameterEntries = jobParameters.getParameters().entrySet();

            System.out.println(String.format("The following %s Job Parameter(s) is/are present:",
                parameterEntries.size()));

            for (Entry<String, JobParameter> jobParameterEntry : parameterEntries) {
                System.out.println(String.format(
                    "Parameter name: %s; isIdentifying: %s; type: %s; value: %s",
                    jobParameterEntry.getKey(),
                    jobParameterEntry.getValue().isIdentifying(),
                    jobParameterEntry.getValue().getType().toString(),
                    jobParameterEntry.getValue().getValue());

                if (jobParameterEntry.getKey().startsWith("context")) {
                    stepExecutionContext.put(jobParameterEntry.getKey(), jobParameterEntry.getValue().getValue());
                }
            }

            if (jobParameters.getString("throwError") != null
                && Boolean.TRUE.toString().equalsIgnoreCase(jobParameters.getString("throwError"))) {

                if (this.counter.compareAndSet(3, 0)) {
                    System.out.println("Counter reset to 0. Execution will succeed.");
                }
                else {
                    this.counter.incrementAndGet();
                    throw new IllegalStateException("Exception triggered by user.");
                }
            }
        }
        return RepeatStatus.FINISHED;
    }

    @Override
    public void beforeStep(StepExecution stepExecution) {
    }

    @Override
    public ExitStatus afterStep(StepExecution stepExecution) {
        // To make the job execution fail, set the step execution to fail
        // and return failed ExitStatus
        // stepExecution.setStatus(BatchStatus.FAILED);
        // return ExitStatus.FAILED;
        return ExitStatus.COMPLETED;
    }
}

```

Package and install the Module:

Follow the instructions in the project [README](#) for more details. The steps are summarized here.

Build the project with maven:

```
$mvn package
```

Upload the jar file to Spring XD and register it as a job module named `myjob` using the Spring XD shell `module upload` command:

```
xd:>module upload --type job --name myjob --file [path-to]/batch-simple/target/springxd-batch-simple-1.0.0.BUILD-SNAPSHOT.jar
```

Modules can reside in an expanded directory named after the module, e.g. `modules/job/myjob` or as a single uber-jar, e.g., `modules/job/myjob.jar`. See [module packaging](#) and [registering a module](#) for more details.

Run the job

Start the Spring XD container if it is not already running.

```
xd:> job create --name helloSpringXD --definition "myjob" --deploy
xd:> job launch helloSpringXD --params {"myStringParameter":"foobar","-secondParam(long)":"123456" }
```

Note

By default, `deploy` is set to *false*. "`--deploy`" or "`--deploy true`" will deploy the job along with job creation.

In the console log of the Spring XD container you should see the following:

```
Hello Spring XD!
The following 3 Job Parameter(s) is/are present:
Parameter name: secondParam; isIdentifying: false; type: LONG; value: 123456
Parameter name: myStringParameter; isIdentifying: true; type: STRING; value: foobar
Parameter name: random; isIdentifying: true; type: STRING; value: 0.06893349621991496
```

24.4 Creating a read-write processing Job

To create a job in the XD shell, execute the `job create` command specifying:

- `name` - the "name" that will be associated with the Job
- `definition` - the name of the job module

Often a batch job will involve reading batches of data from a source, transforming or processing that data and then writing the batch of data to a destination. This kind of flow is implemented using [Chunk-oriented processing](#), represented in the job configuration using the `<chunk/>` element containing `reader`, `writer` and optional `processor` elements. Other attributes define the size of the chunk and various policies for handling failure cases.

You will usually be able to reuse existing [reader](#) and [writer](#) implementations. The [filejdbc job](#) provided with the Spring XD distribution shows an example of this using the standard File reader and JDBC writer.

The processor is based on the `ItemProcessor` interface. It has a generic signature that lets you operate on a record at a time. The batch of records is handled as a collection in reader and writer

implementations. In the `filejdbc` job, the reader converts input records into a [Spring XD Tuple](#). The tuple serves as a generic data structure but you can also use or write another converter to convert the input record to your own custom POJO object.

24.5 Orchestrating Hadoop Jobs

There are several tasklet implementation that will run various types of Hadoop Jobs

- [MapReduce Job](#)
- [HDFS Scripts](#)
- [Hive Scripts](#)
- [Pig Scripts](#)

The [Spring Hadoop Samples](#) project provides examples of how to create batch jobs that orchestrate various hadoop jobs at each step. You can also mix and match steps related to work that is executed on the Hadoop cluster and work that is executed on the Spring XD cluster.

25. Creating a Python Module

25.1 Introduction

Spring XD provides support for [processor](#) and [sink](#) modules that invoke an external shell command. You can use these to integrate a Python script with a Spring XD stream. The following `echo.py` script is a simple example which can implement a processor to simply echo the input.

```
#echo.py
import sys

#=====
# Write data to stdout
#=====
def send(data):
    sys.stdout.write(data)
    sys.stdout.flush()

#=====
# Terminate a message using the default CRLF
#=====
def eod():
    send("\r\n")

#=====
# Main - Echo the input
#=====

while True:
    try:
        data = raw_input()
        if data:
            send(data)
            eod()
    except:
        break
```

To use this in a stream, create a stream definition like this:

```
xd:>stream create pytest --definition "time | shell --command='python <absolute-path-to>/echo.py' | log"
--deploy
Created and deployed new stream 'pytest'
```

Note

Python must be installed on the host of any container to which the processor module is deployed.

You should see the time messages echoed in the Spring XD container log. The shell processor works by binding its message channels to the external process' `stdin` and `stdout`. Behind the scenes, the shell modules use [java.lang.ProcessBuilder](#) to connect to the shell process. As you can see, most of `echo.py` is boilerplate code. To make things easier, Spring XD provides a [python module](#) to handle all of the low level I/O.

```
from springxd.stream import Processor

def echo(data):
    return data

process = Processor()
process.start(echo)
```

As you can see, this creates a `Processor` object which has a `start` method to which you may pass any function that accepts a single argument and returns a value. Currently, both the input and output data must be strings. `Processor` uses `Encoders.CRLF` (`\r\n`) by default. This is how the Spring XD module delimits individual messages in the stream. `Encoders.LF` is also supported. The shell command `processor` also uses `CRLF` by default.

```
xd:>stream create pytest --definition "time | shell --command='python <absolute-path-to>/echo.py' | log"
--deploy
Created and deployed new stream 'pytest'
```

Alternately, you can specify the `LF` encoder in the Python script and the stream definition:

```
from springxd.stream import Processor, Encoders

def echo(data):
    return data

process = Processor(Encoders.LF)
process.start(echo)
```

```
xd:>stream create pytest --definition "time | shell --command='python <absolute-path-to>/echo.py' --
encoder=LF | log" --deploy
```

The `stream` module also provides a similar `Sink` object which accepts a function that need not return a value (`Sink` will ignore the returned value).

Note

In order to import the `springxd.stream` module into your script, you must include it in your Python module search path. Python provides several ways to do this as described [here](#). Spring XD python modules are included in the distribution in the `python` directory. The `stream` module is designed to be version agnostic and has been tested against Python 2.7.6 and Python 3.4.2

26. Providing Module Options Metadata

26.1 Introduction

Each available module can expose metadata about the options it accepts. This is useful to enhance the user experience, and is the foundation to advanced features like contextual help and code completion. For example, provided that the file source module has been enriched with options metadata (and it has), one can use the `module info` command in the shell to get information about the module:

```
xd:> module info source:file
Information about source module 'file':

  Option Name      Description
  Default  Type
  -----
  dir              the absolute path to the directory to monitor for files      <none>
  String
  pattern          a filter expression (Ant style) to accept only files that match the pattern  *
  String
  outputType      how this module should emit messages it produces                <none>
  MediaType
  preventDuplicates  whether to prevent the same file from being processed twice      true
  boolean
  ref              set to true to output the File object itself                    false
  boolean
  fixedDelay      the fixed delay polling interval specified in seconds            5
  int
```

For this to be available, module authors have to provide a little bit of extra information, known as "Module Options Metadata". That metadata can take two forms, depending on the needs of the module: one can either use the "simple" approach, or the "POJO" approach. If one does not need advanced features like profile activation, validation or options encapsulation, then the "simple" approach is sufficient.

26.2 Using the "Simple" approach

To use the simple approach, simply create a file named `<module>.properties` right next to the `<module>.xml` file for your module.

Declaring and documenting an option

In that file, each option `<option>` is declared by adding a line of the form

```
options.<option>.description = the description
```

The description for the option is the only required part, and is a very important piece of information for the end user, so pay special attention to it (see also [Style remarks](#))

That sole line in the properties file makes a `--<option>=` construct available in the definition of a stream using your module.

About plugin provided options metadata

Some options are automatically added to a module, depending on its type. For example, every source module automatically inherits a `outputType` option, that controls the [type conversion](#) feature between modules. You don't have to do anything for that to happen.

Similarly, every job module benefits from a handful of [job specific options](#).

Here is a recap of those automatically provided options:

Module Type	Options
Source	outputType
Processor	outputType, inputType
Sink	inputType
Job	makeUnique, numberFormat, dateFormat

Advertising default values

In addition to this, one can also provide a default value for the option, using

```
options.<option>.default = SomeDefault
```

Doing this, the default value should **not** be used in the placeholder syntax in the xml file. Assuming this is the contents of `foo.properties`:

```
options.bar.description = a very useful option
options.bar.default = 5
```

then in `foo.xml`:

```
<!-- this is correct -->
<feature the-bar="${bar}" />

<!-- this is incorrect/not needed -->
<feature the-bar="${bar:5}" />
```

Exposing the option type

Lastly, one can document the option type using a construct like

```
options.<option>.type = fully.qualified.class.Name
```

For simple "primitive" types, one can use short names, like so:

```
options.<option>.type = String
or
options.<option>.type = boolean
or
options.<option>.type = Integer
```

Note that there is support for both wrapper types (e.g. Integer) and primitive types (e.g. int). Although this is used for documentation purposes only, the primitive type would typically be used to indicate a **required** option (null being prohibited).

26.3 Using the "POJO" approach

To use advanced features such as profile activation driven by the values provided by the end user, one would need to leverage the "POJO" approach.

Instead of writing a properties file, you will need to write a custom java class that will hold the values at runtime. That class is also introspected to derive metadata about your module.

Declaring options to the module

For the simplest cases, the class you need to write does not need to implement or inherit from anything. The only thing you need to do is to reference it in a properties file named after your module (the same file location you would have used had you been leveraging the "simple" approach):

```
options_class = fully.qualified.name.of.your.Pojo
```

Note that the key is `options_class`, with an `s` and an underscore (not to be confused with `option.<optionname>` that is used in the "simple" approach)

For each option you want available using the `--<option>=` syntax, you must write a public setter annotated with `@ModuleOption`, providing the option description in the annotation.

The type accepted by that setter will be used as the documented type.

That setter will typically be used to store the value in a private field. How the module application can get ahold of the value is the topic of the next section.

Exposing values to the context

For a provided value to be used in the module definition (using the `${foo}` syntax), your POJO class needs to expose a `getFoo()` getter.

At runtime, an instance of the POJO class will be created (it requires a no-arg constructor, by the way) and values given by the user will be bound (using setters). The POJO class thus acts as an intermediate `PropertySource` to provide values to `${foo}` constructs.

Providing defaults

To provide default values, one would most certainly simply store a default value in the backing field of a getter/setter pair. That value (actually, the result of invoking the matching getter to a setter on a newly instantiated object) is what is advertised as the default.

Encapsulating options

Although one would typically use the combination of a `foo` field and a `getFoo()`, `setFoo(x)` pair, one does not have to.

In particular, if your module definition requires some "complex" (all things being relative here) value to be computed from "simpler" ones (e.g. a *suffix* value would be computed from an *extension* option, that would take care of adding a dot, depending on whether it is blank or not), then you'd simply do the following:

```
1 public class MyOptions {
    private String extension;

    @ModuleOption("the file extension to use")
5 public void setExtension(String extension) {
    this.extension = extension;
    }

    public String getSuffix() {
10    return extension == null ? null : "." + extension;
    }
}
```

This would expose a `--extension=` option, being surfaced as a `${suffix}` placeholder construct.

The astute reader will have realized that the default can not be computed then, because there is no `getExtension()` (and there should not be, as this could be mistakenly used in `${extension}`). To provide the default value, you should use the `defaultValue` attribute of the `@ModuleOption` annotation.

Using profiles

The real benefit of using a POJO class for options metadata comes with advanced features though, one of which is dynamic profile activation.

If the set of beans (or xml namespaced elements) you would define in the module definition file depends on the value that the user provided for one or several options, then you can make your POJO class implement `ProfileNamesProvider`. That interface brings one contract method, `profilesToActivate()` that you must implement, returning the names of the profiles you want to use (this method is invoked **after** user option values have been bound, so you can use any logic involving those to compute the list of profile names).

As an example of this feature, see e.g. `TriggerSourceOptionsMetadata`.

Using validation

Your POJO class can optionally bear JSR303 annotations. If it does, then validation will occur after values have been successfully bound (understand that injection can fail early due to type incoherence by the way. This comes for free and does not require JSR303 annotations).

This can be used to validate a set of options passed in (some are often mutually exclusive) or to catch misconfiguration earlier than deployment time (e.g. a port number cannot be negative).

26.4 Metadata style remarks

To provide a uniform user experience, it is better if your options metadata information adheres to the following style:

- option names should follow the `camelCase` syntax, as this is easier with the POJO approach. If we later decide to switch to a more `unix-style`, this will be taken care of by XD itself, with no change to the metadata artifacts described here
- description sentences should be concise
- descriptions should start with a **lowercase** letter and should **not** end with a dot
- use primitive types for required numbers
- descriptions should mention the unit for numbers (e.g. ms)
- descriptions should **not** describe the default value, to the best extent possible (this is surfaced through the actual *default* metadata awareness)
- options metadata should know about the default, rather than relying on the `${foo:default}` construct == Extending Spring XD

26.5 Introduction

This document describes how to customize or extend the Spring XD Container. Spring XD is a distributed runtime platform delivered as executable components including XD Admin, XD Container, and XD Shell. The XD Container is a Spring application combining XML resources, Java `@Configuration` classes, and Spring Boot auto configuration for its internal configuration, initialized via the Spring Boot [SpringApplicationBuilder](#). Since Spring XD is open source, the curious user can see exactly how it is configured. However, all Spring XD's configuration is bundled in jar files and therefore not directly accessible to end users. Most users do not need to customize or extend the XD Container. For those that do, Spring XD provides hooks to:

- Provide additional bean definitions
- Override selected bean definitions with custom implementations

Customization scenarios might include:

- Add a [new data transport](#)
- Add a Spring XD [plugin](#) to configure modules
- Embed a [shared component](#) used by user provided Plugin, such as a GemFire cache or a data source
- [Providing additional type converters](#)

The following sections provide an overview of XD Container internals and explain how to extend Spring XD for each of these scenarios. The reader is expected to have a working knowledge of both the Spring Framework and Spring Integration.

26.6 Spring XD Application Contexts

The diagram below shows how Spring XD is organized into several Spring application contexts. Some understanding of the Spring XD application context hierarchy is necessary for extending XD. In the diagram, solid arrows indicate a parent-child relationship. As with any Spring application a child application context may reference beans defined in its parent application context, but the parent context cannot access beans defined in the child context. It is important to keep in mind that a bean definition registered in a child context with the same id as a bean in the parent context will create a separate instance in the child context. Similarly, any bean definition will override an earlier bean definition in the same application context registered with the same id (Sometimes referred to as "last one wins").

Spring XD's primary extension mechanism targets the *Plugin Context* highlighted in the diagram. Using a separate convention, it is also possible to register an alternate MessageBus implementation in the *Shared Server Context*.

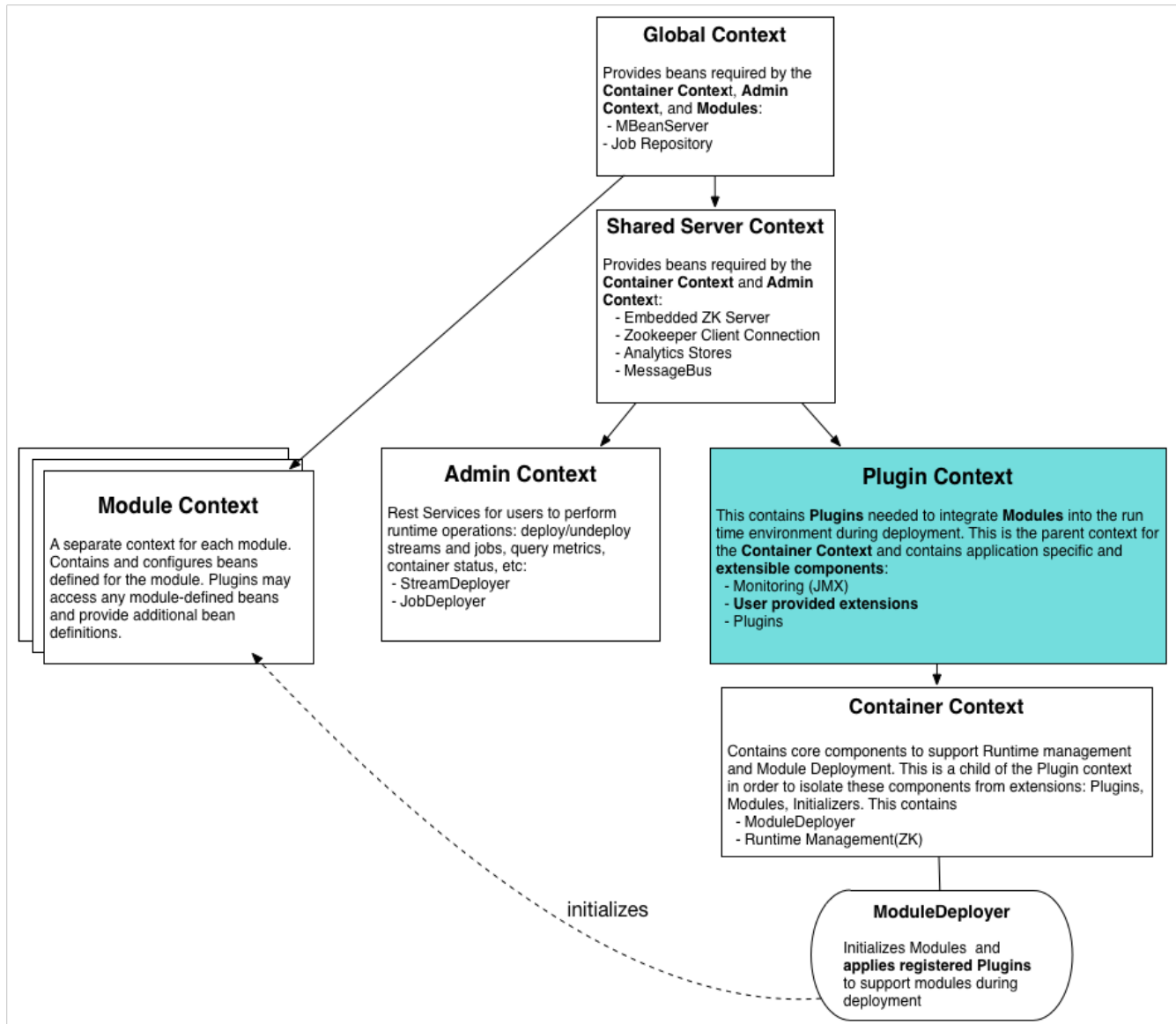

Figure 26.1. The Spring XD Application Context Hierarchy

While this arrangement of application contexts is more complex than the typical Spring application, XD is designed this way for the following reasons:

- **Bean isolation** - Some beans are "global" in that they are shared by all XD runtime components: Admin, Container, and Modules. Those allocated to the *Shared Server Context* are shared only by Admin and Container. Some beans must be available to [Plugins](#), used to configure *Modules*. However Plugins and Modules should be isolated from critical internal components. While complete isolation has proven difficult to achieve, the intention is to minimize any undesirable side effects when introducing extensions.
- **Bean scoping** - To ensure that single node and distributed configurations of the Spring XD runtime are logically equivalent, the Spring configuration is identical in both cases, avoiding unnecessary duplication of bean definitions.
- **Lifecycle management** - Plugins and other beans used to configure these application contexts are also Spring beans which Spring XD dynamically "discovers" during initialization. Such components must be fully instantiated prior to the creation of the application context to which they are targeted.

To ensure initialization happens in the desired order, such beans may be either defined in an isolated application context (i.e., not part of the hierarchy) or in a parent context which Spring initializes before any of its descendants.

26.7 Plugin Architecture

The XD Container at its core is simply a runtime environment for hosting and managing micro Spring applications called *Modules*. Each module runs in its own application context (*Module Context*). The Module Context is a child of *Global Context*, as modules share some bean definitions, but otherwise is logically isolated from beans defined in the XD Container. The *Module Context* is fundamental to the Spring XD design. In fact, this is what allows each module to define its own *input* and *output* channels, and in general, enables beans be uniquely configured via property placeholders evaluated for each deployed instance of a Module. The [Module](#) interface and its default implementation provide a thin wrapper around a Spring Application Context for which properties are bound, profiles activated, and beans added or enhanced in order to "plug" the module into the XD Container.

The *ModuleDeployer*, shown in the diagram, is a core component of the Container Context, responsible for initializing modules during deployment, and shutting them down during undeployment. The ModuleDeployer sees the module as a "black box", unaware of its purpose or runtime requirements. Binding a module's channels to XD's data transport, for instance, is the responsibility of the [MessageBus](#) implementation configured for the transport. The MessageBus binding methods are actually invoked by the *StreamPlugin* during the initialization of a stream module. To support jobs, XD provides a *JobPlugin* to wire the Spring Batch components defined in the module during deployment. The JobPlugin also invokes the MessageBus to support communications between XD and job modules. These, and other functions critical to Spring XD are performed by classes that implement the [Plugin](#) interface. A Plugin operates on every deployed Module which it is implemented to support. Thus the ModuleDeployer simply invokes the deployment life cycle methods provided by every Plugin registered in the Plugin Context.

The ModuleDeployer discovers registered Plugins by calling `getBeansOfType(Plugin.class)` for the *Plugin Context* (its parent context). This means that adding your own Plugin requires these steps:

- Implement the [Plugin](#) interface
- Add your Plugin implementation and any dependent classes to Spring XD's class path
- Follow conventions that Spring XD uses to register Plugins

The next section covers these steps in more detail.

26.8 How to Add a Spring bean to the XD Container

This section applies to adding a *Plugin*, which is generally useful since a Plugin has access to every module as it is being deployed (see the previous section on Plugin Architecture). Furthermore, this section describes a generic mechanism for adding any bean definition to the *Plugin Context*. Spring XD uses both Spring Framework's class path component scanning and resource resolution to find any components that you add to specified locations in the class path. This means you may provide Java `@Configuration` and/or any classes annotated with the `@Component` stereotype in a configured base package in addition to bean definitions defined in any XML or Groovy resource placed under a configured resource location. These locations are given by the properties `xd.extensions.locations` and `xd.extensions.basepackages`, optionally configured in `servers.yml` down at the bottom:

```
# User Extensions: Where XD scans the class path to discover extended container configuration to add
# beans to the Plugins context.
# Each property may be a comma delimited string. 'basepackages' refers to package names used for
# annotated component (@Configuration or @Component stereotypes) scanning. 'locations' is a list of root
# resource directories containing XML or Groovy configuration.
# XD prepends classpath:* if no prefix included and appends **/*. * to each location
#xd:
#  extensions:
#    basepackages: com.acme.xd.extensions
#    locations: META-INF/spring-xd/ext
```

As the pluralization of these property names suggests, you may represent multiple values as a comma delimited string. Also note that there is no default for `xd.extensions.basepackages`. So if you want to use annotation based configuration, you must first set up one or more base package locations. The resource location(s) define the root locations where any XML or Groovy Spring bean definition file found in the given root or any of its subdirectories will be loaded. The root location defaults to `META-INF/spring-xd/ext`

The Container loads any bean definitions found in these configured locations on the class path and adds them to the Plugin Context. This is the appropriate application context since in order to apply custom logic to modules, you will most likely need to provide a custom Plugin.

Note

The extension mechanism is very flexible. In theory, one can define `BeanPostProcessors`, `BeanFactoryPostProcessors`, or `ApplicationListeners` to manipulate Spring XD application contexts. Do so at your own risk as the Spring XD initialization process is fairly complex, and not all beans are intended to be extensible.

Extensions are packaged in a jar file which must be added to Spring XD's class path. Currently, you must manually copy the jar to `$XD_HOME/lib` for each container instance. To implement a Plugin, you will need to include a compile time dependency on `spring-xd-module` in your build. To access other container classes and to test your code in a container you will also require `spring-xd-dirt`.

26.9 Providing A new Type Converter

Spring XD supports [automatic type conversion](#) to convert payloads declaratively. For example, to convert an object to JSON, you provide the module option `--outputType=application/json` to a module used in a stream definition. The conversion is enabled by a *Plugin* that binds a Spring [MessageConverter](#) to a media type. The default type converters are currently configured in [streams.xml](#), packaged in `spring-xd-dirt-<version>.jar`. If you look at that file, you can see an empty list registered as `customMessageConverters`.

```
<!-- Users can override this to add converters.-->
<util:list id="customMessageConverters"/>
```

So registering new type converters is a matter of registering an alternate list as `customMessageConverters` to the application context. Spring XD will replace the default empty list with yours. `xd.messageConverters` and `customMessageConverters` are two lists injected into the `ModuleTypeConversionPlugin` to build an instance of [CompositeMessageConverter](#) which delegates to the first converter in list order that is able to perform the necessary conversion. The Plugin injects the `CompositeMessageConverter` into the module's *input* or *output* the [MessageChannel](#), corresponding to the `inputType` or `outputType` options declared for any module in the stream definition (or defined as the module's default `inputType`).

The `CompositeMessageConverter` is desirable because a module does not generally know what payload type it will get from its predecessor. For example, the converters that Spring XD provides out of the box can convert any Java object, including a [Tuple](#) and a byte array to a JSON String. However the methods for converting a byte array or a Tuple are each optimized for the respective type. The `CompositeMessageConverter` for `--outputType=application/json` must provide all three methods and the Data Type channel chooses the first converter that applies to both the incoming payload type and the media type (e.g., `application/json`). Note that the order that the converters appear in the list is significant. In general, converters for specific payload types precede more general converters for the same media type. The `customMessageConverters` are added after the standard converters in the order defined. So it is generally easier to add converters for new media types than to replace existing converters.

For example, a member of the Spring XD community inquired about Spring XD's support for [Google protocol buffers](#). This user was interested in integrating Spring XD with an existing messaging system that uses GPB heavily and needed a way to convert incoming and outgoing GPB payloads to interoperate with XD streams. This could be accomplished by providing a `customMessageConverters` bean containing a list of required message converters. Writing a custom converter to work with XD requires extending [AbstractFromMessageConverter](#) provided by `spring-xd-dirt`. It is recommended to review the existing implementations listed in [streams.xml](#) to get a feel for how to do this. In addition, you would likely define a custom [MimeType](#) such as `application/gpb`.

Note

It is worth mentioning that GPB is commonly used for marshaling objects over the network. In the context of Spring XD marshaling is treated as a separate concern from payload conversion. In Spring XD, marshaling happens at the "pipe" indicated by the `|` symbol using a different serialization mechanism, described below. In this case, the GPB payloads are produced and consumed by systems external to Spring XD and need to be converted in order that a GPB payload can work with XD streams. In this scenario, if the GPB is represented as a byte array, the bytes are transmitted over the network directly and marshaling is unnecessary.

As an illustration, suppose this user has developed a source module that emits GPB payloads from a legacy service. Spring XD provides transform and filter modules that accept SpEL expressions to perform their respective tasks. These modules are useful in many situations but the SpEL expressions generally require a POJO representing a domain type, or a JSON string. In this case it would be convenient to support stream definitions such as

```
gpb-source --outputType=application/x-java-object | transform --expression=...
```

where `gpb-source` represents a custom module that emits a GPB payload and `expression` references some specific object property. The media type `application/x-java-object` is a convention used by XD to indicate that the payload should be converted to a Java type embedded in the serialized representation (GPB in this example). Alternately, converting to JSON could be performed if the stream definition were:

```
gpb-source --outputType=application/json | transform --expression=...
```

To convert an XD stream result to GPB to be consumed by an external service might look like:

```
source | P1 ... | Pn | gpb-sink --inputType=application/gpb
```

These examples would require registering custom `MessageConverters` to handle the indicated conversions. Alternately, this may be accomplished by writing custom processor modules to perform the required conversion. The above examples would then have stream definitions that look more like:

```
gpb-source | gpb-to-pojo | transform --expression=...
source | P1 ... | Pn | json-to-gpb | gpb-sink
```

Tip

While custom processor modules are easier to implement, they add unnecessary complexity to stream definitions that use them. If such conversions are required everywhere, enabling automatic conversion may be worth the effort. Also, note that using a separate module generally requires additional network hops (at each pipe). If a processor module is necessary only to perform a common payload conversion, it is more efficient to install a custom converter.

26.10 Adding a New Data Transport

Spring XD offers Redis and Rabbit MQ for data transport out of the box. Transport is configured simply by setting the property `xd.transport` to `redis` or `rabbit`. In addition `xd-singlenode` supports a `--transport` command line option that can accept `local`(the single node default) in addition. This simple configuration mechanism is supported internally by an import declaration that binds the transport implementation to a name.

```
<import resource="classpath*/META-INF/spring-xd/transport/${XD_TRANSPORT}-bus.xml"/>
```

The above snippet is from an internal Spring configuration file loaded into the *Shared Server Context*. Spring XD provides MessageBus implementations in `META-INF/spring-xd/transport/redis-bus.xml` and `META-INF/spring-xd/transport/rabbit-bus.xml`

This makes it relatively simple for Spring XD developers and advanced users to provide alternate MessageBus implementations to enable a new transport and activate that transport by setting the `xd.transport` property. For example, to implement a JMS MessageBus you would add a jar containing `/META-INF/spring-xd/transport/jms-bus.xml` in the class path. This file must register a bean of type `MessageBus` with the ID `messageBus`. A jar providing the above configuration file along with the MessageBus implementation and any dependencies must be installed `$XD_HOME/lib`.

When implementing a MessageBus, it is advisable to review and understand the existing implementations which extend [MessageBusSupport](#). This base class performs some common tasks including payload marshaling. Spring XD uses the term *codec* to connote a component that performs both serialization and deserialization and provides a bean with the same name. In the example above, the JMS MessageBus configuration `/META-INF/spring-xd/transport/jms-bus.xml` might look something like:

```
<bean id="messageBus" class="my.example.JmsMessageBus">
  <constructor-arg ref="jmsConnectionFactory" />
  <constructor-arg ref="codec"/>
</bean>
```

where `JmsMessageBus` extends `MessageBusSupport` and the developer is responsible for configuring any dependent JMS resources appropriately.

27. Samples

We have a number of sample projects in the [Spring XD Samples GitHub repository](#). Below are some additional examples for ingesting syslog data to HDFS.

27.1 Syslog ingestion into HDFS

In this section we will show a simple example on how to setup syslog ingestion from multiple hosts into HDFS.

Create the streams with syslog as source and HDFS as sink (Please refer to [source](#) and [sink](#))

If you're using syslog over TCP and need the highest throughput, use the Reactor-backed syslog module.

```
xd:> stream create --definition "reactor-syslog --port=<tcp-port> | hdfs" --name <stream-name>
```

The `reactor-syslog` module doesn't yet support UDP (though it soon will), so if you're using syslog over UDP you'll want to use the standard syslog module.

```
xd:> stream create --definition "syslog-udp --port=<udp-port> | hdfs" --name <stream-name>
```

```
xd:> stream create --definition "syslog-tcp --port=<tcp-port> | hdfs" --name <stream-name>
```

Please note for hdfs sink, set `rollover` parameter to a smaller value to avoid buffering and to see the data has made to HDFS (incase of smaller volume of log).

Configure the external hosts' syslog daemons forward their messages to the xd-container host's UDP/TCP port (where the syslog-udp/syslog-tcp source module is deployed).

A sample configuration using syslog-ng

Edit syslog-ng configuration (for example: `/etc/syslog-ng/syslog-ng.conf`):

1) Add destination

```
destination <destinationName> {
    tcp("<host>" port("<tcp-port>"));
};
```

or,

```
destination <destinationName> {
    udp("<host>" port("<udp-port>"));
};
```

where "host" is the container(launcher) host where the syslog module is deployed.

2) Add log rule to log message sources:

```
log {
    source(<message_source>); destination(<destinationName>);
};
```

3) Make sure to restart the service after the change:

```
sudo service syslog-ng restart
```

Now, the syslog messages from the syslog message sources are written into HDFS `/xd/<stream-name>/`

Part III. Configuration Guidelines

28. Overview

When running a distributed Spring XD runtime, there are a number of considerations related to performance and reliability. In most cases, these involve settings that have tradeoffs, but in this section we provide some background so you know what the options are and how to configure them.

In the [Deployment](#) section that follows, we provide detailed information about various properties that can be passed along with the `stream deploy` command. That section also describes a scenario that is common for minimizing network hops, where direct binding can occur between modules rather than having each pipe within a stream correspond to a send and receive over the Message Bus. For more detail see the [Direct Binding](#) subsection.

Another relevant topic for minimizing network hops is the ability to *compose* modules. That is a useful technique where a subset of the stream's contiguous modules can be grouped together as if a single module. All of the pipes within the composed module will rely upon a local transport rather than sending and receiving via the Message Bus. For more detail read the [Composing Modules](#) section.

For production use, high availability will typically be a requirement for the data transport. In the [Message Bus Configuration](#) section below, we provide details on the relevant [HA configuration](#) settings as well as other reliability settings, security settings (including [enabling SSL](#)), and [error-handling](#) capabilities.

When configuring a RabbitMQ Message Bus, you will also want to consider several performance settings. For example, unless strict sequential ordering is required, the *prefetch* and *concurrency* values should be overridden (the default for each is 1). That can lead to a significant performance improvement. In the less likely case that performance concerns completely outweigh reliability, you can disable acknowledgements and even disable the persistence of messages. For a listing of these settings and more, refer to the [RabbitMQ Configuration](#) section. Several performance related configuration settings exist on the broker itself, and those are well-documented in the [RabbitMQ Admin Guide](#). For example, the *vm_memory_high_watermark* and *vm_memory_high_watermark_paging_ratio* are both explained within the [Flow Control](#) subsection of the guide.

If you are using the HTTP source module in a stream and want to scale, you can deploy multiple instances by specifying the *module.http.count* property as described in the [Deployment Properties](#) section. Keep in mind that each instance will share the same port value. The default is 9000, but that can be overridden, for all instances, by including `--port` as an option for the HTTP module in the stream definition. That means you would want to ensure that each container that may be a candidate for deploying one of the HTTP module instances (taking into account the *criteria* deployment property if provided), is running on a different host, either physically or on separate virtual machines. Of course, in a production environment, you would likely want to add a load balancer in front of those HTTP endpoints.

Also when using the HTTP source module, you may want to consider enabling support for HTTPS. An example is provided in the documentation for that module's [options](#).

29. Deployment

29.1 Introduction

This section covers topics related to deployment, including:

- [The Deployment Manifest](#)
- [Deployment States](#)
- [Container Attributes](#)
- [Stream Partitioning](#)
- [Direct Binding](#)
- [Troubleshooting](#)

When you deploy a [Stream](#) or [Job](#), the Spring XD Runtime performs the following steps:

- parse the stream or job definition ([DSL Guide](#)) to resolve each Module reference along with its options
- set option values assigned to each component [Module](#)
- parse and store the deployment request including the [Deployment Manifest](#)
- allocate each Module to an available Container instance in accordance with the Deployment Manifest
- binding Module channel(s), either to the [MessageBus](#) or directly using [Direct Binding](#)
- track the state of each deployed module
- track the overall stream or job's [Deployment State](#)

29.2 Deployment Manifest

A stream is composed of modules. Each module is deployed to one or more Container instance(s). In this way, stream processing is distributed among multiple containers. By default, deploying a stream to a distributed runtime configuration uses simple round robin logic. For example if there are three containers and three modules in a stream definition, $s1 = m1 \mid m2 \mid m3$, then Spring XD will attempt to distribute the work load evenly among each container. This is a very simplistic strategy and does not take into account things like:

- server load - how many modules are already deployed to a container? What is the current memory and CPU utilization?
- server affinity - some containers may have external software installed and specific modules will benefit from co-location. For example, an hdfs sink might be deployed only to hosts running Hadoop. Or perhaps a file sink should be deployed to hosts configured with extra disk space.
- scalability - Suppose the stream $s1$, above, can achieve higher throughput with multiple instances of $m2$ running, so we want to deploy $m2$ to every available container.
- fault tolerance - the ability to target physical servers on redundant networks, routers, racks, etc.

Generally, more complex deployment strategies are needed to tune and operate XD. Additionally, we must consider various features and constraints when deploying to a PaaS, Yarn or some other cluster manager. Additionally, Spring XD allows supports [Stream Partitioning](#) and [Direct Binding](#).

To address such deployment concerns, Spring XD provides a *Deployment Manifest* which is submitted with the deployment request, in the form of in-line deployment properties (or potentially a reference to a separate document containing deployment properties).

Deployment Properties

When you execute the `stream deploy` shell command, you can optionally provide a `properties` parameter which is a comma delimited list of key=value pairs. Examples for the key include **module.[modulename].count** and **module.[modulename].criteria** (for a full list of properties, see below). The value for the count is a positive integer, and the value for criteria is a valid SpEL expression. The Spring XD runtime matches an available container for each module according to the deployment manifest.

The deployment properties allow you to specify deployment instructions for each module. Currently this includes:

- The number of module instances
- A target server or server group
- MessageBus attributes required for a specific module
- Stream Partitioning
- Direct Binding
- History Tracking

General Properties

Note

You can apply criteria to all modules in the stream by using the wildcard `*` for `[modulename]`

`module.[modulename].count`

The number of module instances (see above).

`module.[modulename].criteria`

A boolean SpEL expression using the [Container Attributes](#) as an evaluation context.

`module.[modulename].trackHistory`

A boolean value indicating whether history should be tracked in a message header for this module. Usually used during stream development or for debugging, with `module.*.trackHistory=true` to track all modules. The `xdHistory` message header contains an entry for each module that processes the message; each entry includes useful information including the stream name, module label, host, container id, thread name, etc. This enables the determination of exactly how a message was processed through the stream(s).

Example:

```
xd:>stream deploy --name test1 --properties
"module.transform.count=3,module.log.criteria=groups.contains('group1')"
```

Bus Properties

Common Bus Properties

Note

The following properties are only allowed when using a *RabbitMessageBus* or a *RedisMessageBus*; the *LocalMessageBus* does not support properties.

`module.[modulename].consumer.backOffInitialInterval`

The number of milliseconds to wait for the first delivery retry (**default 1000**)

`module.[modulename].consumer.backOffMaxInterval`

The maximum number of milliseconds to wait between retries (**default 10000**)

`module.[modulename].consumer.backOffMultiplier`

The previous retry interval is multiplied by this to determine the current interval (but see *backOffMaxInterval*) (**default 2.0**)

`module.[modulename].consumer.concurrency`

The number of concurrent consumers for the module (**default 1**).

`module.[modulename].consumer.maxAttempts`

The maximum number of attempts to make a delivery when a failure occurs (**default 3**)

RabbitMQ Bus Properties

Note

The following properties are only allowed when using a *RabbitMessageBus*.

See the Spring AMQP reference documentation for information about the RabbitMQ-specific attributes.

`module.[modulename].consumer.ackMode`

Controls message acknowledgements (**default AUTO**)

`module.[modulename].consumer.maxConcurrency`

The maximum number of concurrent consumers for the module (**default 1**).

`module.[modulename].consumer.prefetch`

The number of messages prefetched from the RabbitMQ broker (**default 1**)

`module.[modulename].consumer.prefix`

A prefix applied to all queues/exchanges that are declared by the bus - allows policies to be applied (**default xdbus.**)

`module.[modulename].consumer.requestHeaderPatterns`

Controls which message headers are passed between modules (**default STANDARD_REQUEST_HEADERS,***)

`module.[modulename].consumer.replyHeaderPatterns`

Controls which message headers are passed between modules (only used in partitioned jobs) (**default STANDARD_REPLY_HEADERS,***)

`module.[modulename].consumer.requeue`

Whether messages will be requeued (and retried) on failure (**default true**)

module.[modulename].consumer.transacted

Whether consumers use transacted channels (**default false**)

module.[modulename].consumer.txSize

The number of delivered messages between acknowledgements (when *ackMode=AUTO*) (**default 1**)

module.[modulename].consumer.durableSubscription

When true, publish/subscribe named channels (*tap:*, *topic:*) will be backed by a durable queue and will be eligible for dead-letter configuration, according to the *autBindDLQ* setting. Note that, since RabbitMQ doesn't permit queue attributes to be changed, changing the *durableSubscription* property from true to false between deployments, without first removing the queue, will not have any effect. If a stream is deployed with *durableSubscription=true*, and you wish to change it to a non-durable subscription, you will need to remove the queue from RabbitMQ before redeploying. Spring XD will create the queue with the appropriate settings, unless the queue exists already. Changing from a non-durable subscription to a durable subscription will not have this problem because, for a non-durable subscription, the queue will be automatically deleted when the stream is undeployed.

module.[modulename].producer.deliveryMode

The delivery mode of messages sent to RabbitMQ (*PERSISTENT* or *NON_PERSISTENT*) (**default PERSISTENT**)

module.[modulename].producer.requestHeaderPatterns

Controls which message headers are passed between modules (**default STANDARD_REQUEST_HEADERS,***)

module.[modulename].producer.replyHeaderPatterns

Controls which message headers are passed between modules (only used in partitioned jobs) (**default STANDARD_REPLY_HEADERS,***)

module.[modulename].consumer.autoBindDLQ

When true, the bus will automatically declare dead letter queues and binding for each bus queue. The user is responsible for setting a policy on the broker to enable dead-lettering; see [Message Bus Configuration](#) for more information. The bus will configure a dead-letter-exchange (*<prefix>DLX*) and bind a queue with the name *<original queue name>.dlq* and route using the original queue name..

module.[modulename].consumer.republishToDLQ

By default, failed messages after retries are exhausted are rejected. If a dead-letter queue (DLQ) is configured, rabbitmq will route the failed message (unchanged) to the DLQ. Setting this property to *true* instructs the bus to republish failed messages to the DLQ, with additional headers, including the exception message and stack trace from the cause of the final failure. Note that the republish will occur even if *maxAttempts* is only set to 1. Also see *autoBindDLQ* (**default false**)

module.[modulename].producer.batchingEnabled

Batch messages sent to the bus (**default false**)

module.[modulename].producer.batchSize

The normal batch size, may be preempted by *batchBufferLimit* or *batchTimeout* (**default 100**)

module.[modulename].producer.batchBufferLimit

If a batch will exceed this limit, the batch will be sent prematurely (**default 10000**)

module.[modulename].producer.batchTimeout

If no messages are received in this time (ms), the batch will be sent **(default 5000)**

module.[modulename].producer.compress

When *true*, compress the message before sending to rabbit; **(default false)** see [RabbitMQ Message Bus Properties](#) for information about the compression level

Stream Partitioning

Note

Partitioning is only allowed when using a *RabbitMessageBus* or a *RedisMessageBus*.

A common pattern in stream processing is to partition the data as it is streamed. This entails deploying multiple instances of a message consuming module and using content-based routing so that messages containing the identical data value(s) are always routed to the same module instance. You can use the Deployment Manifest to declaratively configure a partitioning strategy to route each message to a specific consumer instance.

Partition Properties

See below for examples of deploying [partitioned streams](#).

module.[modulename].producer.partitionKeyExtractorClass

The class name of a *PartitionKeyExtractorStrategy* **(default null)**

module.[modulename].producer.partitionKeyExpression

A *SpEL* expression, evaluated against the message, to determine the partition key; only applies if *partitionKeyExtractorClass* is null. If both are null, the module is not partitioned **(default null)**

module.[modulename].producer.partitionSelectorClass

The class name of a *PartitionSelectorStrategy* **(default null)**

module.[modulename].producer.partitionSelectorExpression

A *SpEL* expression, evaluated against the partition key, to determine the partition index to which the message will be routed. The final partition index will be the return value (an integer) modulo *[nextModule].count*. If both the class and expression are null, the bus's default *PartitionSelectorStrategy* will be applied to the key **(default null)**

In summary, a module is partitioned if its *count* is > 1 and the previous module has a *partitionKeyExtractorClass* or *partitionKeyExpression* (class takes precedence). When a partition key is extracted, the partitioned module instance is determined by invoking the *partitionSelectorClass*, if present, or the *partitionSelectorExpression % count*. If neither is present the result is *key.hashCode() % count*.

Direct Binding

Sometimes it is desirable to allow co-located, contiguous modules to communicate directly, rather than using the configured remote transport, to eliminate network latency. Spring XD creates direct bindings by default only in cases where every "pair" of producer and consumer (modules bound on either side of a pipe) are guaranteed to be co-located.

Currently Spring XD implements no conditional logic to force modules to be co-located. The only way to guarantee that every producer-consumer pair is co-located is to specify that the pair be deployed

to every available container instance, in other words, the module counts must be 0. The figure below illustrates this concept. In the first hypothetical case, we deploy one instance (the default) of producer m1, and two instances of the consumer m2. In this case, enabling direct binding would isolate one of the consumer instances. Spring XD will not create direct bindings in this case. The second case guarantees co-location of the pairs and will result in direct binding.

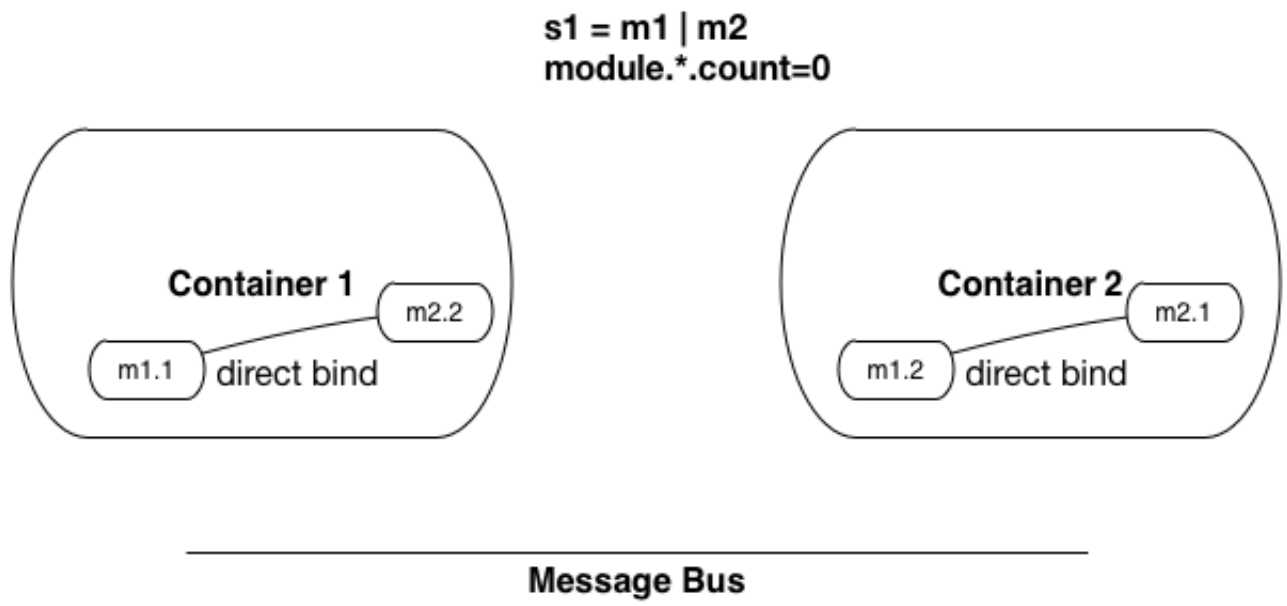
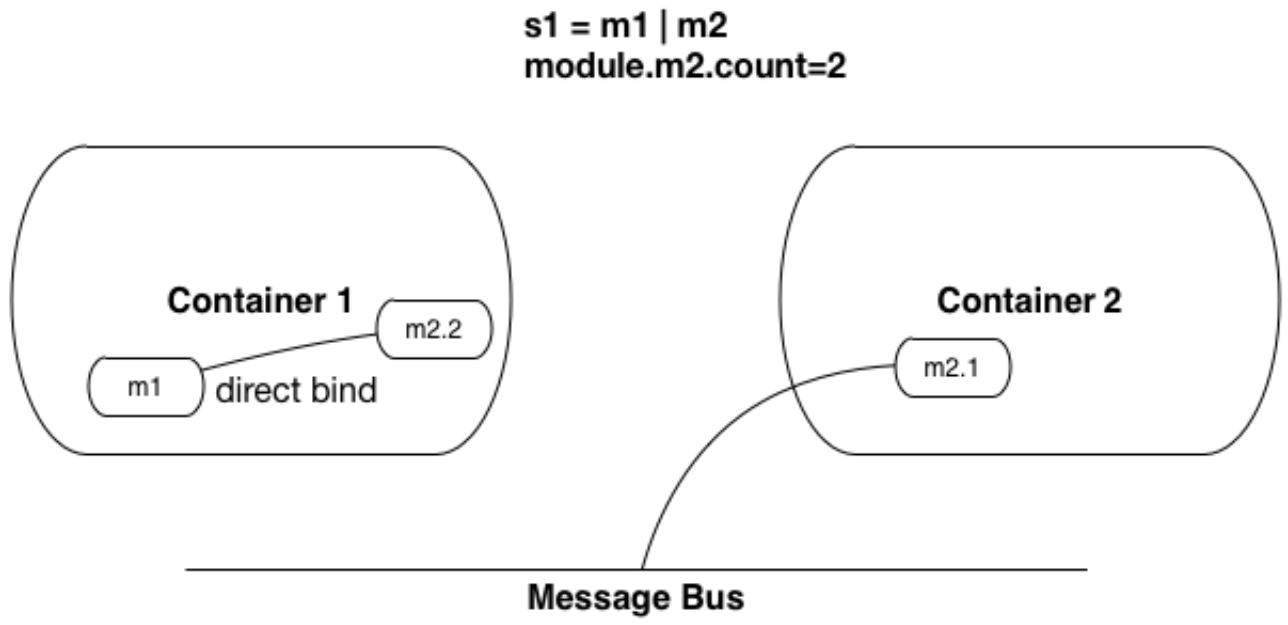

In addition, direct binding requires that the producer is not configured for [partitioning](#) since partitioning is **implemented** by the Message Bus.

Using `module.*.count=0` is the most straightforward way to enable direct binding. Direct binding may be disabled for the stream using `module.*.producer.directBindingAllowed=false`. Additional [direct binding deployment examples](#) are shown below.

29.3 Deployment States

The ability to specify criteria to match container instances and deploy multiple instances for each module leads to one of several possible deployment states for the stream as a whole. Consider a stream in an initial *undeployed* state.

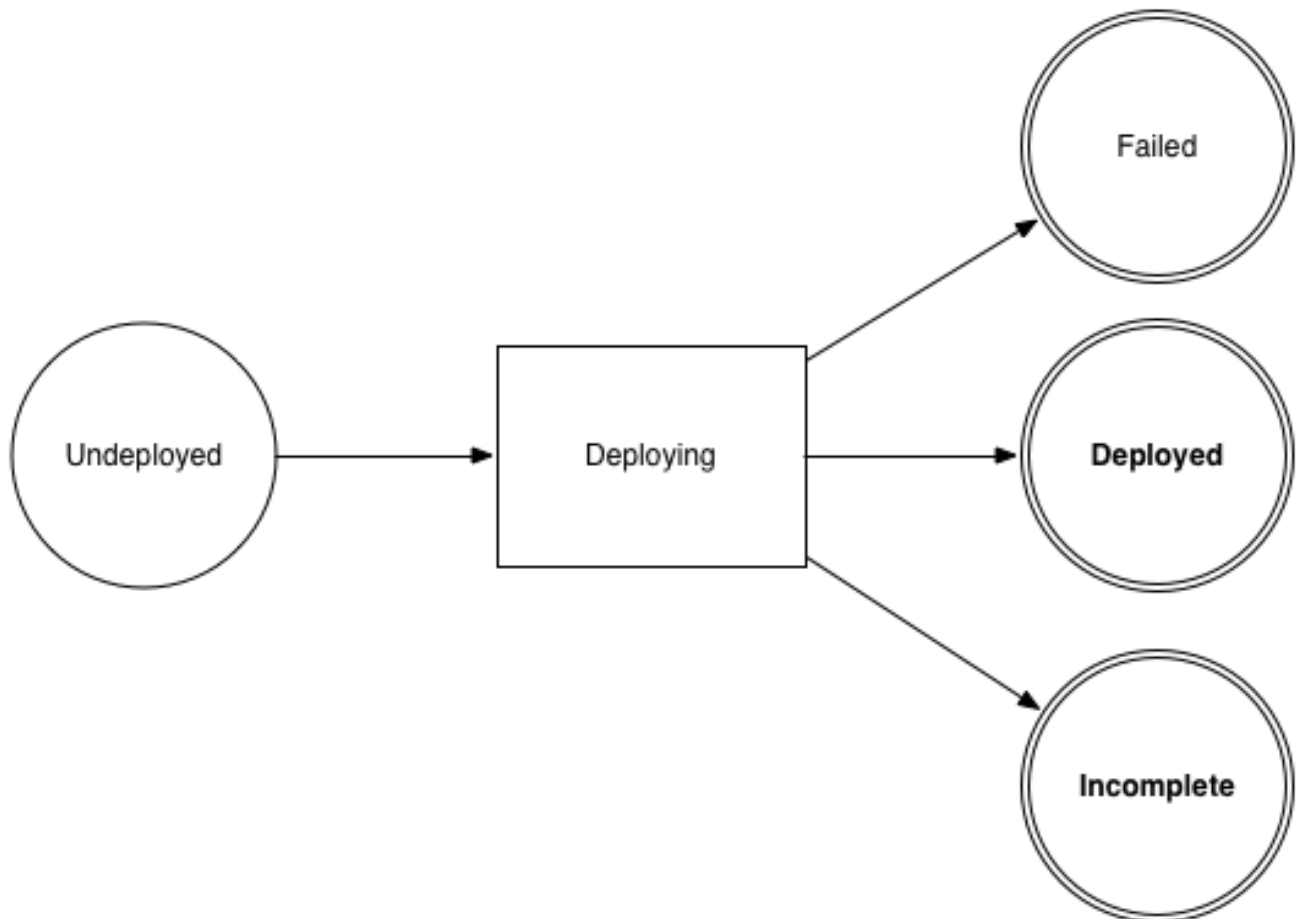

After executing the stream deployment request, the stream will be one of the following states:

- **Deployed** - All modules deployed successfully as specified in the deployment manifest.
- **Incomplete** - One of the requested module instances could not be deployed, but at least one instance of each module definition was successfully deployed. The stream is operational and can process messages end-to-end but the deployment manifest was not completely satisfied.
- **Failed** - At least one of the module definitions was not deployed. The stream is not operational.

Note

The state diagram above represents these states as final. This is an over-simplification since these states are affected by container arrivals and departures that occur during or after the execution of a deployment request. Such transitions have been omitted intentionally but are worth considering.

Also, there is an analogous state machine for undeploying a stream, initially in any of these states, which is left as an exercise for the reader.

Example

```
xd:>stream create test1 --definition "http | transform --expression=payload.toUpperCase() | log"
Created new stream 'test1'
```

Next, deploy it requesting three transformer instances:

```
xd:>stream deploy --name test1 --properties "module.transform.count=3"
Deployed stream 'test1'

xd:>stream list
Stream Name  Stream Definition                                     Status
-----
test1        http | transform --expression=payload.toUpperCase() | log  incomplete
```

If there are only two container instances available, only two instances of *transform* will be deployed. The stream deployment state is *incomplete* and the stream is functional. However the unfulfilled deployment request remains active and the third instance will be deployed if a new container comes on line that matches the criteria.

29.4 Container Attributes

The SpEL context (root object) for `module.[modulename].criteria` is `ContainerAttributes`, basically a map derivative that contains some standard attributes:

- **id** - the generated container ID
- **pid** - the process ID of the container instance
- **host** - the host name of the machine running the container instance
- **ip** — the IP address of the machine running the container instance

`ContainerAttributes` also includes any user-defined attribute values configured for the container. These attributes are configured by editing `xd/config/servers.yml` the file included in the XD distribution contains some commented out sections as examples. In this case, the container attributes configuration looks something like:

```
xd:
  container:
    groups: group2
    color: red
```

Groups

Groups may be assigned to a container via the optional command line argument `--groups` or by setting the environment variable `XD_CONTAINER_GROUPS`. As the property name suggests, a container may belong to more than one group, represented as comma-delimited string. The concept of server groups is considered an especially useful convention for targeting groups of servers for deployment to support many common scenarios, so it enjoys special status. Internally, *groups* is simply a user defined attribute.

IP Address

The IP address of the container can also be optionally set via the command argument `--containerip` or by setting the environment variable `XD_CONTAINER_IP`. If not specified, the IP address will be

automatically set. Please be aware of the limitations, though, particularly in cases where the physically machine has multiple IP addresses assigned.

For the automatic assignment of the IP address, XD internally loops through the available network interfaces and assigned IP addresses and will pick the first available IPv4 address that is not a loopback address.

Depending on your underlying server or network infrastructure, you may prefer specifying the IP address explicitly.

Hostname

The hostname of the container can be optionally set as well via the command argument `--containerHostname` or by setting the environment variable `XD_CONTAINER_HOSTNAME`. If not specified, the hostname will be automatically set. Please be aware of the [limitations](#), though. You may prefer specifying the hostname address explicitly.

Tip

While there is no command line option to set the container hostname and IP address when running in Single Node mode, you can still specify the values via environment variables or by customizing the respective settings in `application.yml`

29.5 Stream Deployment Examples

To illustrate how to use the Deployment Manifest, We will use a runtime configuration with 3 container instances, as displayed in the XD shell:

```
xd:>runtime containers
Container Id          Host          IP Address      PID  Groups  Custom Attributes
-----
bc624816-f8a8-4f35-83f6-a125ed147b7c ip-10-110-18-10  10.110.18.10  1708 group2  {color=red}
018b7c8d-6fa9-4759-8471-76899766f892 ip-10-139-36-168  10.139.36.168  1852 group2  {color=blue}
afc3741c-217a-415a-9d86-a1f62de03613 ip-10-139-17-116  10.139.17.116  1861 group1  {color=green}
```

Each of the three containers is running on a different host and has configured Groups and Custom Attributes as shown.

First, create a stream:

```
xd:>stream create test1 --definition "http | transform --expression=payload.toUpperCase() | log"
Created new stream 'test1'
```

Next, deploy it using a manifest:

```
xd:>stream deploy --name test1 --properties
"module.transform.count=3,module.log.criteria=groups.contains('group1')"
Deployed stream 'test1'
```

Verify the deployment:

```

xd:>runtime modules
Module                Container Id          Options
Deployment Properties
-----
-----
test1.processor.transform.1 bc624816-f8a8-4f35-83f6-a125ed147b7c {valid=true,
expression=payload.toUpperCase()} {count=3, sequence=1}
test1.processor.transform.2 018b7c8d-6fa9-4759-8471-76899766f892 {valid=true,
expression=payload.toUpperCase()} {count=3, sequence=2}
test1.processor.transform.3 afc3741c-217a-415a-9d86-alf62de03613 {valid=true,
expression=payload.toUpperCase()} {count=3, sequence=3}
test1.sink.log.1           afc3741c-217a-415a-9d86-alf62de03613 {name=test1, expression=payload,
level=INFO} {count=1, sequence=1, criteria=groups.contains('group1')}
test1.source.http.1        bc624816-f8a8-4f35-83f6-a125ed147b7c {port=9000}
                             {count=1, sequence=1}

```

We can see that three instances of the *transform* processor have been deployed, one to each container instance. Also the log module has been deployed to the container assigned to *group1*. Now we can undeploy and deploy the stream using a different manifest:

```

xd:>stream undeploy test1
Un-deployed stream 'test1'
xd:>runtime modules
Module Container Id Properties
-----
-----

xd:>stream deploy --name test1 --properties "module.log.count=3,module.log.criteria=!
groups.contains('group1')"
Deployed stream 'test1'

xd:>stream list
Stream Name Stream Definition Status
-----
-----
test1 http | transform --expression=payload.toUpperCase() | log incomplete

xd:>runtime modules
Module                Container Id          Options
Deployment Properties
-----
-----
-----
test1.processor.transform.1 018b7c8d-6fa9-4759-8471-76899766f892 {valid=true,
expression=payload.toUpperCase()} {count=1, sequence=1}
test1.sink.log.1           bc624816-f8a8-4f35-83f6-a125ed147b7c {name=test1, expression=payload,
level=INFO} {count=3, sequence=1, criteria=!groups.contains('group1')}
test1.sink.log.2           018b7c8d-6fa9-4759-8471-76899766f892 {name=test1, expression=payload,
level=INFO} {count=3, sequence=2, criteria=!groups.contains('group1')}
test1.source.http.1        afc3741c-217a-415a-9d86-alf62de03613 {port=9000}
                             {count=1, sequence=1}

```

Now there are only two instances of the *log* module deployed. We asked for three however the deployment criteria specifies only containers not in *group1* are eligible. The *log* module is deployed only to the two containers matching the criteria. The deployment status of stream *test1* is shown as *incomplete*. The stream is functional even though the deployment manifest is not completely satisfied. If we fire up a new container not in *group1*, the DeploymentSupervisor will handle any outstanding deployment requests by comparing *xd/deployments/modules/requested* to *xd/deployments/modules/allocated*, and will deploy the third *log* instance and update the stream state to *deployed*.

29.6 Partitioned Stream Deployment Examples

Using SpEL Expressions

First, create a stream:

```

xd:>stream create --name partitioned --definition "jms | transform --
expression=#expensiveTransformation(payload) | log"

Created new stream 'partitioned'

```

The hypothetical SpEL function *expensiveTransformation* represents a resource intensive processor which we want to load balance by running on multiple containers. In this case, we also want to partition the stream so that payloads containing the same *customerId* are always routed to the same processor instance. Perhaps the processor aggregates data by *customerId* and this step needs to run using co-located resources.

Next, deploy it using a manifest:

```

xd:>stream deploy --name partitioned --properties
"module.jms.producer.partitionKeyExpression=payload.customerId,module.transform.count=3"

Deployed stream 'partitioned'

```

In this example three instances of the transformer will be created (with partition index of 0, 1, and 2). When the *jms* module sends a message it will take the *customerId* property on the message payload, invoke its *hashCode()* method and apply the modulo function with the divisor being the *transform.count* property to determine which instance of the transform will process the message (**`payload.getCustomerId().hashCode() % 3`**). Messages with the same *customerId* will always be processed by the same instance.

29.7 Direct Binding Deployment Examples

In the simplest case, we enforce direct binding by setting the instance count to 0 for all modules in the stream. A count of 0 means deploy the module to all available containers:

```

xd:>runtime containers

```

Container Id	Host	IP Address	PID	Groups	Custom Attributes
8e814924-15de-4ca1-82d3-ddfe851668ab	ultrafox.local	192.168.1.18	81532		
a2b89274-2d40-46e4-afc5-4988bea28a16	ultrafox.local	192.168.1.9	4605	group1	

We start with two container instances. One belongs to the group *group1*.

```

xd:>stream create direct --definition "time | log"
Created new stream 'direct'
xd:>stream deploy direct --properties module.*.count=0
Deployed stream 'direct'
xd:>runtime modules

```

Module	Container Id	Options
Deployment Properties		
direct.sink.log.0	a2b89274-2d40-46e4-afc5-4988bea28a16	{name=direct, expression=payload, level=INFO} {count=0, sequence=0}
direct.sink.log.0	8e814924-15de-4ca1-82d3-ddfe851668ab	{name=direct, expression=payload, level=INFO} {count=0, sequence=0}
direct.source.time.0	a2b89274-2d40-46e4-afc5-4988bea28a16	{fixedDelay=1, format=yyyy-MM-dd HH:mm:ss} {producer.directBindingAllowed=true, count=0, sequence=0}
direct.source.time.0	8e814924-15de-4ca1-82d3-ddfe851668ab	{fixedDelay=1, format=yyyy-MM-dd HH:mm:ss} {producer.directBindingAllowed=true, count=0, sequence=0}

Note that we have two containers and two instances of each module deployed to each. Spring XD automatically sets the bus properties needed to allow direct binding, *producer.directBindingAllowed=true* on the *time* module.

Suppose we only want one instance of this stream and we want it to use direct binding. Here we can add deployment criteria to restrict the available containers to *group1*.

```
xd:>stream undeploy direct
Un-deployed stream 'direct'
xd:>stream deploy direct --properties "module.*.count=0, module.*.criteria=groups.contains('group1')"
Deployed stream 'direct'
xd:>runtime modules
  Module                Container Id                Options
  Deployment Properties
  -----
  -----
  direct.sink.log.0     a2b89274-2d40-46e4-afc5-4988bea28a16 {name=direct, expression=payload,
level=INFO} {count=0, sequence=0, criteria=groups.contains('group1')}
  direct.source.time.0 a2b89274-2d40-46e4-afc5-4988bea28a16 {fixedDelay=1, format=yyyy-MM-dd HH:mm:ss}
  {producer.directBindingAllowed=true, count=0, sequence=0, criteria=groups.contains('group1')}
```

Direct binding eliminates latency between modules but sacrifices some of the resiliency provided by the messaging middleware. In the scenario above, if we lose one of the containers, we lose messages. To disable direct binding when module counts are set to 0, set *module.*.producer.directBindingAllowed=false*.

```
xd:>stream undeploy direct
Un-deployed stream 'direct'
xd:>stream deploy direct --properties "module.*.count=0, module.*.producer.directBindingAllowed=false"
Deployed stream 'direct'
xd:>runtime modules
  Module                Container Id                Options
  Deployment Properties
  -----
  -----
  direct.sink.log.0     a2b89274-2d40-46e4-afc5-4988bea28a16 {name=direct, expression=payload,
level=INFO} {producer.directBindingAllowed=false, count=0, sequence=0}
  direct.sink.log.0     8e814924-15de-4ca1-82d3-ddfe851668ab {name=direct, expression=payload,
level=INFO} {producer.directBindingAllowed=false, count=0, sequence=0}
  direct.source.time.0 a2b89274-2d40-46e4-afc5-4988bea28a16 {fixedDelay=1, format=yyyy-MM-dd HH:mm:ss}
  {producer.directBindingAllowed=false, count=0, sequence=0}
  direct.source.time.0 8e814924-15de-4ca1-82d3-ddfe851668ab {fixedDelay=1, format=yyyy-MM-dd HH:mm:ss}
  {producer.directBindingAllowed=false, count=0, sequence=0}
```

Finally, we can still have the best of both worlds by enabling guaranteed delivery at one point in the stream, usually the source. If the tail of the stream is co-located and the source uses the message bus, the message bus may be configured so that if a container instance goes down, any unacknowledged messages will be retried until the container comes back or its modules are redeployed.

TDB: A realistic example

An alternate scenario with similar characteristics would be if the stream uses a *rabbit* or *jms* source. In this case, guaranteed delivery would be configured in the external messaging system instead of the Spring XD transport.

29.8 Troubleshooting

Debugging a distributed system to diagnose problems can be challenging. While using Spring XD, if you encounter

ZooKeeper disconnects

Problem: Spring XD processes disconnecting from ZooKeeper

Recommendation: Depending on your setup, modify either `xd-singlenode` or `xd-container` scripts by setting the environment variable `export JAVA_OPTS=-verbose:gc` before launching them.

Reason: ZooKeeper requires a heartbeat at a regular interval to test liveness of connected processes. Full "stop the world" GCs can result in connection and session timeouts from ZooKeeper. While verbose, GC logs are helpful for diagnosing this and other performance issues.

Debugging Slowness

Problem: Slow or unresponsive application

Recommendation: Capture multiple thread dumps several seconds apart using `jstack`.

Reason: Examination of thread dumps can reveal stuck or slow moving threads. This data is useful for determining the root cause of a slow or unresponsive application.

File Descriptors and limit violation

Problem: `java.io.FileNotFoundException: (Too many open files)`

Recommendation: Default `ulimit` setting in most UNIX based operating systems is 1024. Raise `ulimit` setting to at least 10000.

Reason: Stream and job modules in Spring XD are loaded and unloaded dynamically on demand. When a module is unloaded, the associated class loaders may not be garbage collected right away, resulting in open file handles for the jar files used by the module. Depending on the number of modules in use, the file handle limit of 1024 may be exceeded.

30. Message Bus Configuration

30.1 Introduction

This section contains additional information about configuring the Message Bus, including High Availability, SSL, and Error handling.

30.2 Rabbit Message Bus High Availability (HA) Configuration

The `RabbitMessageBus` allows for HA configuration using normal [RabbitMQ HA Configuration](#).

First, use the `addresses` property in `servers.yml` to include the host/port for each server in the cluster. See [Application Configuration](#).

By default, queues and exchanges declared by the bus are prefixed with `xdbus.` (this prefix can be changed as described in [Application Configuration](#)).

To configure the entire bus for HA, create a policy:

```
rabbitmqctl set_policy ha-xdbus "^xdbus\." '{"ha-mode":"all"}'
```

30.3 Error Handling (Message Delivery Failures)

RabbitMQ Message Bus

Note

The following applies to normally deployed streams. When direct binding between modules is being used, exceptions thrown by the consumer are thrown back to the producer.

When a consuming module (processor, sink) fails to handle a message, the bus will retry delivery based on the module (or default bus) retry configuration. The default configuration will make 3 attempts to deliver the message. The retry configuration can be modified at the bus level (in `servers.yml`), or for an individual stream/module using the deployment manifest.

When retries are exhausted, by default, messages are discarded. However, using RabbitMQ, you can configure such messages to be routed to a dead-letter exchange/dead letter queue. See the [RabbitMQ Documentation](#) for more information.

Note

The following configuration examples assume you are using the default bus prefix used for naming rabbit elements: `"xdbus."`

Consider a stream: `stream create foo --definition "source | processor | sink"`

The first *pipe* (by default) will be backed by a queue named `xdbus.foo.0`, the second by `xdbus.foo.1`. Messages are routed to these queues using the default exchange (with routing keys equal to the queue names).

To enable dead lettering just for this stream, first configure a policy:

```
rabbitmqctl set_policy foo.DLX "^xdbus\.foo\..*" '{"dead-letter-exchange":"foo.dlx"}' --apply-to queues
```

To configure dead-lettering for all streams:

```
rabbitmqctl set_policy DLX "^xdbus\..*" '{"dead-letter-exchange":"dlx"}' --
apply-to queues
```

The next step is to declare the dead letter exchange, and bind dead letter queues with the appropriate routing keys.

For example, for the second "pipe" in the stream above we might bind a queue `foo.sink.dlq` to exchange `foo.dlx` with a routing key `xdbus.foo.1` (remember, the original routing key was the queue name).

Now, when the sink fails to handle a message, after the configured retries are exhausted, the failed message will be routed to `foo.sink.dlq`.

There is no automated mechanism provided to move dead lettered messages back to the bus queue.

Automatic Dead Lettering Queue Binding

Starting with *version 1.1*, the dead letter queue and binding can be automatically configured by the system. A new property `autoBindDLQ` has been added; it can be set at the bus level (in `servers.yml`) or using deployment properties, e.g. `--properties module.*.consumer.autoBindDLQ=true` for all modules in the stream. When `true`, the dead letter queue will be declared (if necessary) and bound to a dead letter exchange named `xdbus.DLX` (again, assuming the default `prefix`) using the queue name as the routing key.

In the above example, where we have queues `xdbus.foo.0` and `xdbus.foo.1`, the system will also create `xdbus.foo.0.dlq`, bound to `xdbus.DLX` with routing key `xdbus.foo.0` and `xdbus.foo.1.dlq`, bound to `xdbus.DLX` with routing key `xdbus.foo.1`.

Note

Starting with *version 1.2*, any queues that are deployed with `autoBindDLQ` will automatically be configured to enable dead-lettering, routing to the DLX with the proper routing key. It is no longer necessary to use a policy to set up dead-lettering when using `autoBindDLQ`.

Also, starting with *version 1.2*, the provision of dead-lettering on publish/subscribe named channels (`tap:` or `topic:`) depends on a new deployment property `durable`. This property is similar to a JMS durable subscription to a topic and is `false` by default. When `false` (default), the queue backing such a named channel is declared `auto-delete` and is removed when the stream is undeployed. A DLQ will not be created for such queues. When `true`, the queue becomes permanent (durable) and is not removed when the stream is undeployed. Also, when `true`, the queue is eligible for DLQ provisioning, according to the `autoBindDLQ` deployment property. `durable` can be set at the bus level, or in an individual deployment property, such as:

```
stream create ticktock --definition="time --fixedDelay=5 | log" --deploy
stream create ttap --definition="tap:stream:ticktock > log" stream deploy
ttap --properties=module.log.consumer.durableSubscription=true
```

Redis Message Bus

When Redis is the transport, the failed messages (after retries are exhausted) are LPUSH+ed to a `+LIST ERRORS:<stream>.n` (e.g. `ERRORS:foo.1` in the above example in the *RabbitMQ Message Bus* section).

This is unconditional; the data in the `ERRORS LIST` is in "bus" format; again, as with the RabbitMQ Message Bus, some external mechanism would be needed to move the data from the `ERRORS LIST` back to the bus's `foo.1 LIST`.

Note

When moving errored messages back to the main stream, it is important to understand that these messages contain binary data and are unlikely to survive conversion to and from `Unicode` (such as with `Java String` variables). If you use Java to move these messages, we recommend that you use a `RedisTemplate` configured as follows:

```
<bean id="redisTemplate"
      class="org.springframework.data.redis.core.RedisTemplate">
  <property name="connectionFactory" ref="jedisConnectionFactory" />
  <property name="keySerializer">
    <bean
      class="org.springframework.data.redis.serializer.StringRedisSerializer" />
  </property>
  <property name="enableDefaultSerializer" value="false" />
</bean>
```

or

```
@Bean
public RedisTemplate<String, byte[]> redisTemplate() {
    RedisTemplate<String, byte[]> template = new RedisTemplate<String, byte[]>();
    template.setConnectionFactory(connectionFactory());
    template.setKeySerializer(new StringRedisSerializer());
    template.setEnableDefaultSerializer(false);
    return template;
}
```

This enables the message payload to be retained as `byte[]` with no conversion; you would then use something like...

```
byte[] errorEvt = redisTemplate.opsForList().rightPop(errorQueue);
redisTemplate.opsForList().leftPush(destinationQueue, errorEvt);
```

If, after moving a message, you see an error such as:

```
redis.RedisMessageBus$ReceivingHandler - Could not convert message: EFBFBD...
```

This is a sure sign that a `UTF-8 # Unicode # UTF-8` conversion was performed on the message.

30.4 Rabbit Message Bus Secure Sockets Layer (SSL)

If you wish to use SSL for communications with the RabbitMQ server, consult the [RabbitMQ SSL Support Documentation](#).

First configure the broker as described there. The message bus is a client of the broker and supports both of the described configurations for connecting clients (*SSL without certificate validation* and *with certificate validation*).

To use SSL without certificate validation, simply set

```
spring:
  rabbitmq:
    useSSL: true
```

In `application.yml` (and set the port(s) in the `addresses` property appropriately).

To use SSL with certificate validation, set

```
spring:
  rabbitmq:
    useSSL: true
    sslProperties: file:path/to/secret/ssl.properties
```

The `sslProperties` property is a Spring resource (`file:`, `classpath:` etc) that points to a properties file. Typically, this file would be secured by the operating system (and readable by the XD container) because it contains security information. Specifically:

```
keyStore=file:/secret/client/keycert.p12
trustStore=file:/secret/trustStore
keyStore.passPhrase=secret
trustStore.passPhrase=secret
```

Where the `pkcs12` keystore contains the client certificate and the truststore contains the server's certificate as described in the rabbit documentation. The key/trust store properties are Spring resources.

Note

By default, the `rabbit` source and sink modules inherit their default configuration from the container, but it can be overridden, either using `modules.yml` or with specific module definitions.

30.5 Rabbit Message Bus Batching and Compression

See [RabbitMQ Message Bus Properties](#) for information about batching and compressing messages passing through the bus.

Part IV. Administration

31. Monitoring and Management

Spring XD uses Spring Boot's monitoring and management support over [HTTP](#) and [JMX](#) along with Spring Integration's [MBean Exporters](#)

31.1 Monitoring XD Admin, Container and Single-node servers

Following are available by **default**

JMX is enabled `XD_JMX_ENABLED=true`

The spring boot management endpoints are exposed over HTTP and since JMX is enabled these endpoints are exposed over JMX

Spring integration components are exposed over JMX using `IntegrationMBeanExporter`

All the available MBeans can be accessed over HTTP using `Jolokia`

To enable boot provided management endpoints over HTTP

When starting admin, container or singlenode server, the command-line option `--mgmtPort` can be specified to use an explicit port for management server. With the given valid management port, the management endpoints can be accessed from that port. Please refer Spring Boot document [here](#) for more details on the endpoints.

For instance, once XD admin is started on localhost and the management port set to use the admin port (9393)

```
http://localhost:9393/management/health
http://localhost:9393/management/env
http://localhost:9393/management/beans
etc..
```

To enable the container shutdown operation in the UI

Add the following configuration to `config/servers.yml`. This configuration is available as a commented section in `config/servers.yml`.

```
---
spring:
  profiles: container
management:
  port: 0
```

To disable boot endpoints over HTTP

Set `management.port=-1` for both default and container profiles in `config/servers.yml`

31.2 Management over JMX

All the boot endpoints are exposed over JMX with the domain name `org.springframework.boot`. The MBeans that are exposed within XD admin, container server level are available with the domain names `xd.admin` (for XD admin), `xd.container` (for XD container), `xd.shared.server` and `xd.parent` representing the application contexts common to both XD admin and container. Singlenode

server will have all these domain names exposed. When the stream/job gets deployed into the XD container, the stream/job MBeans are exposed with specific domain/object naming strategy.

To disable management over JMX

Set `XD_JMX_ENABLED=false` in `config/servers.yml` or set it as an environment variable to disable the management over JMX

Monitoring deployed modules in XD container

When a module is deployed (with JMX is enabled on the XD container), the `IntegrationMBeanExporter` is injected into module's context via `MBeanExportingPlugin` and this exposes all the spring integration components inside the module. For the given module, the `IntegrationMBeanExporter` uses a specific object naming strategy that assigns domain name as `xd.<stream/job name>` and, object name as `<module name>.<module index>`.

Streams

For a stream name `mystream` with DSL `http | log` will have

MBeans with domain name `xd.mystream` with two objects `http.0` and `log.1`

Source, processor, and sink modules will generally have the following attributes and operations

Module Type	Attributes and Operations
Source	MessageSourceMetrics
Processor,Sink	MessageHandlerMetrics

In addition, each module has channel attributes and operations defined by [MessageChannelMetrics](#).

Jobs

For a job name `myjob` with DSL `jdbchdfs` will have

MBeans with domain name `xd.myjob` with an object `jdbchdfs.0`

You can also obtain monitoring information for Jobs using the UI or accessing the Job management REST API. Documentation for the Job Management REST API is forthcoming, but until then please reference the request mappings in [BatchJobsController](#), [BatchJobExecutionsController](#), [BatchStepExecutionsController](#), and [BatchJobInstancesController](#).

31.3 Using Jolokia to access JMX over http

When JMX is enabled (which is **default** via `XD_JMX_ENABLED` property), Jolokia is auto-configured to expose the XD admin, container and singenode server MBeans.

For example, with XD singlenode running management port 9080

```
http://localhost:9393/management/jolokia/search/xd*:*,component=MessageChannel
```

will list all the `MessageChannel` MBeans exposed in XD container. Apart from this, other available domain and types can be accessed via Jolokia.

32. REST API

32.1 Introduction

The Spring XD Administrator process (Admin) provides a REST API to access various Spring XD resources such as streams, jobs, metrics, modules, Spring batch resources, and container runtime information. The REST API is used internally by the XD Shell and Admin UI and can support any custom client application that requires interaction with XD.

The HTTP port is configurable and may be set as a command line argument when starting the Admin server, or set in `$XD_HOME/config/servers.yml`. The default port is 9393:

```
> $XD_HOME/bin/xd-admin --httpPort <port>
```

The Admin server also exposes runtime management resources enabled by Spring Boot under the `/management` context path, e.g., <http://localhost:9393/management/metrics>. These resources are covered in the [Spring Boot](#) documentation.

Note

There is also a `mgmtPort` command line argument which assigns a separate port for management services. Normally the same port is used for everything.

32.2 XD Resources

Table 32.1. Table XD REST endpoints

stream definitions	/streams/definitions
stream deployments	/streams/deployments
job definitions	/jobs/definitions
job deployments	/jobs/deployments
batch job configurations	/jobs/configurations
batch job executions	/jobs/executions
batch job instances	/jobs/instances
module definitions	/modules
deployed modules	/runtime/modules
containers	/runtime/containers
counters	/metrics/counters
field value counters	/metrics/field-value-counters
aggregate counters	/metrics/aggregate-counters
gauges	/metrics/gauges

rich-gauges	/metrics/rich-gauges
completions	/completions

32.3 Stream Definitions

Table 32.2. Table Stream Definitions

Resource URL	Request Method	Description
/streams/definitions	GET	list defined streams along with deployment state
/streams/definitions	DELETE	delete all stream definitions, undeploying deployed streams
/streams/definitions/{name}	GET	get a stream definition (currently no deployment information is included)
/streams/definitions	POST	create a new stream, optionally deploying it if <code>deploy=true</code> (default). The request body is application/x-www-form-urlencoded and requires two parameters, <code>name</code> and <code>definition</code> (DSL)
/streams/definitions/{name}	DELETE	delete a stream, undeploying if deployed.

32.4 Stream Deployments

Table 32.3. Table Stream Deployments

Resource URL	Request Method	Description
/streams/deployments/	GET	get detailed deployment state for all streams (TBD)
/streams/deployments	DELETE	undeploy all streams
/streams/deployments/{name}	GET	get detailed deployment state for a stream (TBD)
/streams/deployments/{name}	POST	deploy a stream, where the request body contains the deployment properties application/x-www-form-urlencoded
/streams/deployments/{name}	DELETE	undeploy a stream

32.5 Job Definitions

Table 32.4. Table Job Definitions

Resource URL	Request Method	Description
/jobs/definitions	GET	list defined jobs along with deployment state
/jobs/definitions	DELETE	delete all job definitions, undeploying deployed jobs
/jobs/definitions/{name}	GET	get a job definition
/jobs/definitions	POST	create a new job, where the request body is application/x-www-form-urlencoded and requires two parameters, <code>name</code> and <code>definition</code> (DSL)
/jobs/definitions/{name}	DELETE	delete a job, undeploying if deployed

32.6 Job Deployments

Table 32.5. Table Job Deployments

Resource URL	Request Method	Description
/jobs/deployments/	GET	get detailed deployment state for all jobs (TBD)
/jobs/deployments	DELETE	undeploy all jobs
/jobs/deployments/{name}	GET	get detailed deployment state for a job (TBD. Probably not in 1.0)
/jobs/deployments/{name}	POST	deploy a job, where the request body contains the deployment properties
/jobs/deployments/{name}	DELETE	undeploy a job

32.7 Batch Job Configurations

Spring Batch configured jobs stored in the Spring Batch Repository

Table 32.6. Table Batch Jobs

Resource URL	Request Method	Description
/jobs/configurations	GET	get configuration information about all batch jobs
/jobs/configurations/{jobName}	GET	get configuration information about a batch job

32.8 Batch Job Executions

Table 32.7. Table Batch Executions

Resource URL	Request Method	Description
/jobs/executions	GET	list all job executions (Only <i>application/json</i> mediatype supported)
/jobs/executions?stop=true	PUT	stop all jobs
/jobs/executions? jobname={jobName}	GET	get information about all executions of a job (Only <i>application/json</i> accept header is supported)
/jobs/executions? jobname={jobName}	POST	request the launch of a job
/jobs/executions/ {jobExecutionId}	GET	get information about a particular execution of a job
/jobs/executions/ {jobExecutionId}?restart=true	PUT	restart a job
/jobs/executions/ {jobExecutionId}?stop=true	PUT	stop a job
/jobs/executions/ {jobExecutionId}/steps	GET	list the steps for a job execution (Only <i>application/json</i> accept header is supported)
/jobs/executions/ {jobExecutionId}/steps/ {stepExecutionId}	GET	get a step execution
/jobs/executions/ {jobExecutionId}/steps/ {stepExecutionId}/progress	GET	get the step execution progress

32.9 Batch Job Instances

Table 32.8. Table Batch Job Instances

Resource URL	Request Method	Description
/jobs/instances? jobname={jobName}	GET	get information about all instances of a job
/jobs/instances/{instanceId}	GET	get information about a batch job instance

For both the GET endpoints **only** *application/json* accept header is supported.

32.10 Module Definitions

Table 32.9. Table Module Definitions

Resource URL	Request Method	Description
/modules	GET	list all registered modules
/modules	POST	create a composite module, where The request body is application/x-www-form-urlencoded and requires two parameters, name and definition (DSL). The module type is derived from the definition.
/modules/{type}/{name}	POST	upload a module archive (uber jar), where The content type is application/octet-stream and the request body contains the binary archive contents
/modules/{type}/{name}	GET	list a module along with options metadata, where type is source,processor,sink, or job
/modules/{type}/{name}	DELETE	delete a composed or uploaded module

32.11 Deployed Modules

Table 32.10. Table Deployed Modules

Resource URL	Request Method	Description
/runtime/modules	GET	display runtime module option values and deployment information for deployed modules, optional parameters are moduleId (<stream>.<type>.<moduleName>),containerId

32.12 Containers

Table 32.11. Table Containers

Resource URL	Request Method	Description
/runtime/containers	GET	display all available containers along with runtime and user-defined container attributes

32.13 Counters

Table 32.12. Table Counters

Resource URL	Request Method	Description
/metrics/counters/	GET	list all the known counters
/metrics/counters/{name}	GET	get the current metric value
/metrics/counters/{name}	DELETE	delete the metric

32.14 Field Value Counters

Table 32.13. Table Field Value Counters

Resource URL	Request Method	Description
/metrics/field-value-counters/	GET	list all the known field value counters
/metrics/field-value-counters/{name}	GET	get the current metric values
/metrics/field-value-counters/{name}	DELETE	delete the metric

32.15 Aggregate Counters

Table 32.14. Table Aggregate Counters

Resource URL	Request Method	Description
/metrics/aggregate-counters/	GET	list all the known aggregate counters
/metrics/aggregate-counters/{name}	GET	get the current metric values
/metrics/aggregate-counters/{name}	DELETE	delete the metric

32.16 Gauges

Table 32.15. Table Gauges

Resource URL	Request Method	Description
/metrics/gauges/	GET	list all the known gauges
/metrics/gauges/{name}	GET	get the current metric values
/metrics/gauges/{name}	DELETE	delete the metric

32.17 Rich Gauges

Table 32.16. Table Rich Gauges

Resource URL	Request Method	Description
/metrics/rich-gauges/	GET	list all the known rich gauges
/metrics/rich-gauges/{name}	GET	get the current metric values
/metrics/rich-gauges/{name}	DELETE	delete the metric

32.18 Tab Completions

Used to support DSL tab completion for the XD Shell. All requests require the `start` parameter which contains the incomplete definition.

Table 32.17. Table Tab Completions

Resource URL	Request Method	Description
/completions/stream? start={start}	GET	retrieve valid choices to complete a stream definition
/completions/job?start={start}	GET	retrieve valid choices to complete a job definition
/completions/module? start={start}	GET	retrieve valid choices to complete a module definition

33. JAVA API

33.1 Introduction

The class [SpringXDTemplate](#) lets you interact with Spring XD's REST API in Java. It saves you the trouble of wrapping your own calls to RestTemplate or other REST client libraries. Within Spring XD `SpringXDTemplate` is used to implement shell commands and for testing.

Required Libraries

The following maven snippet will pull in the required dependencies:

```
<dependencies>
  <dependency>
    <groupId>org.springframework.xd</groupId>
    <artifactId>spring-xd-rest-client</artifactId>
    <version>1.0.1.RELEASE</version>
  </dependency>
</dependencies>

<repositories>
  <repository>
    <id>spring-release</id>
    <name>Spring Releases</name>
    <url>http://repo.spring.io/libs-release</url>
  </repository>
</repositories>
```

Note: The artifact is not yet hosted in maven central.

Sample Usage

The program

```
SpringXDTemplate xdTemplate = new SpringXDTemplate(new URI("http://localhost:9393"));
PagedResources<DetailedContainerResource> containers = xdTemplate.runtimeOperations().listContainers();
for (DetailedContainerResource container : containers) {
    System.out.println(container);
}
```

Will produce the following output on a single node server

```
{groups=, host=feynman, id=e4fb54bc-119b-46cc-acb3-cd0b72ccd1df, ip=192.168.70.130, pid=9559}
```

Part V. Appendices

Appendix A. Installing Hadoop

A.1 Installing Hadoop

If you don't have a local *Hadoop* cluster available already, you can do a local [single node installation \(v2.6.0\)](#) and use that to try out *Hadoop* with *Spring XD*.

Tip

This guide is intended to serve as a quick guide to get you started in the context of *Spring XD*. For more complete documentation please refer back to the documentation provided by your respective *Hadoop* distribution.

Download

First, [download an installation archive](#) (hadoop-2.6.0.tar.gz) and unpack it locally. Linux users can also install *Hadoop* through the system package manager and on Mac OS X, you can use [Homebrew](#). However, the manual installation is self-contained and it's easier to see what's going on if you just unpack it to a known location.

If you have `wget` available on your system, you can also execute:

```
$ wget http://archive.apache.org/dist/hadoop/common/hadoop-2.6.0/hadoop-2.6.0.tar.gz
```

Unpack the distribution with:

```
$ tar xzf hadoop-2.6.0.tar.gz
```

Change into the directory and have a look around

```
$ cd hadoop-2.6.0
$ ls
$ bin/hadoop
Usage: hadoop [--config confdir] COMMAND
       where COMMAND is one of:
   fs                run a generic filesystem user client
   version           print the version
   jar <jar>         run a jar file
   ...
```

The `bin` directory contains the start and stop scripts as well as the `hadoop` and `hdfs` scripts which allow us to interact with *Hadoop* from the command line.

Java Setup

Make sure that you set `JAVA_HOME` in the `etc/hadoop/hadoop-env.sh` script, or you will get an error when you start *Hadoop*. For example:

```
# The java implementation to use. Required.
#export JAVA_HOME=${JAVA_HOME}
export JAVA_HOME=/usr/lib/jdk1.7.0_65
```

Tip

When using *Mac OS X* you can determine the *Java* home directory by executing `$ /usr/libexec/java_home -v 1.6`

Tip

When using *Ubuntu* you can determine the *Java* home directory by executing `$ sudo update-java-alternatives -l`

Note

When using *MAC OS X* (Other systems possible also) you may still encounter `Unable to load realm info from SCDynamicStore` (For details see [Hadoop Jira HADOOP-7489](#)). In that case, please also add to `conf/hadoop-env.sh` the following line: `export HADOOP_OPTS="-Djava.security.krb5.realm= -Djava.security.krb5.kdc="`.

Setup SSH

As described in the installation guide, you also need to set up [SSH](#) login to `localhost` without a passphrase. On Linux, you may need to install the `ssh` package and ensure the `sshd` daemon is running. On Mac OS X, `ssh` is already installed but the `sshd` daemon isn't usually running. To start it, you need to enable "Remote Login" in the "Sharing" section of the control panel. Then you can carry on and setup SSH keys as described in the installation guide:

```
$ ssh-keygen -t dsa -P '' -f ~/.ssh/id_dsa
$ cat ~/.ssh/id_dsa.pub >> ~/.ssh/authorized_keys
```

Make sure you can log in at the command line using `ssh localhost` and `ssh 0.0.0.0` before trying to start *Hadoop*:

```
$ ssh localhost
Last login: Thu May 1 15:02:32 2014 from localhost
...
$ ssh 0.0.0.0
Last login: Thu May 1 15:06:02 2014 from localhost
```

You also need to decide where in your local filesystem you want *Hadoop* to store its data. Let's say you decide to use `/data`.

First create the directory and make sure it is writeable:

```
$ mkdir /data
$ chmod 777 /data
```

Now edit `etc/hadoop/core-site.xml` and add the following property:

```
<property>
  <name>hadoop.tmp.dir</name>
  <value>/data</value>
</property>
```

You're then ready to format the filesystem for use by HDFS

```
$ bin/hadoop namenode -format
```

Setting the Namenode Port

By default Spring XD will use a *Namenode* setting of `hdfs://localhost:8020` which can be overridden in `${xd.home}/config/server.yml`, depending on the used *Hadoop* distribution and version the by-default-defined port 8020 may be different, e.g. port 9000. Therefore, please ensure you have the following property setting in `etc/hadoop/core-site.xml`:

```
<property>
  <name>fs.defaultFS</name>
  <value>hdfs://localhost:8020</value>
</property>
```

Further Configuration File Changes

In `etc/hadoop/hdfs-site.xml` add the following properties:

```
<property>
  <name>dfs.replication</name>
  <value>1</value>
</property>
<property>
  <name>dfs.support.append</name>
  <value>true</value>
</property>
<property>
  <name>dfs.webhdfs.enabled</name>
  <value>true</value>
</property>
```

Create `etc/hadoop/mapred-site.xml` and add:

```
<?xml version="1.0"?>
<?xml-stylesheet type="text/xsl" href="configuration.xsl"?>

<configuration>
  <property>
    <name>mapreduce.framework.name</name>
    <value>yarn</value>
  </property>
</configuration>
```

In `etc/hadoop/yarn-site.xml` add these properties:

```
<property>
  <name>yarn.nodemanager.aux-services</name>
  <value>mapreduce_shuffle</value>
</property>
<property>
  <name>yarn.nodemanager.aux-services.mapreduce.shuffle.class</name>
  <value>org.apache.hadoop.mapred.ShuffleHandler</value>
</property>
```

A.2 Running Hadoop

First we need to set up the environment settings. It's convenient to add these to a file that you can source when you want to work with Hadoop. We create a file called `hadoop-env` and add the following content:

```
# The directory of the unpacked distribution
export HADOOP_INSTALL="$HOME/Downloads/hadoop-2.6.0"

# The JAVA_HOME (see above how to determine this)
export JAVA_HOME=/usr/lib/jdk1.7.0_65

# Some HOME settings
export HADOOP_MAPRED_HOME=$HADOOP_INSTALL
export HADOOP_YARN_HOME=$HADOOP_INSTALL
export HADOOP_COMMON_HOME=$HADOOP_INSTALL

# Add Hadoop scripts to the PATH
export PATH=$HADOOP_INSTALL/bin:$HADOOP_INSTALL/sbin:$PATH
```

To use these settings we need to source this script:

```
$ source hadoop-env
```

You should now finally be ready to run *Hadoop*. Run the following commands

```
$ start-dfs.sh
$ start-yarn.sh
$ mr-jobhistory-daemon.sh start historyserver
```

You should see six Hadoop Java processes running:

```
$ jps
21636 NameNode
22004 SecondaryNameNode
22360 NodeManager
22425 JobHistoryServer
21808 DataNode
22159 ResourceManager
22471 Jps
```

Try a few commands with `hdfs dfs` to make sure the basic system works

```
$ hdfs dfs -ls /
Found 1 items
drwxrwx--- - trisberg supergroup      0 2014-11-01 15:31 /tmp

$ hdfs dfs -mkdir /xd
$ bin/hadoop dfs -ls /
Found 2 items
drwxrwx--- - trisberg supergroup      0 2014-11-01 15:31 /tmp
drwxr-xr-x - trisberg supergroup      0 2014-11-01 15:34 /xd
```

Lastly, you can also browse the web interface for *NameNode* and *ResourceManager* at:

- NameNode: <http://localhost:50070/>
- ResourceManager: <http://localhost:8088/>

At this point you should be good to create a *Spring XD stream* using a *Hadoop sink*.

Appendix B. Building Spring XD

B.1 Instructions

Here are some useful steps to build and run Spring XD.

Warning

Please ensure that you provide as a minimum *6GB of available RAM* for a full build. The executed integration tests use several embedded services such as [Apache Kafka](#), [Apache ZooKeeper](#) and [Apache Hadoop](#) which contribute to the high resource usage.

To build all sub-projects and run tests for Spring XD (please note tests require a running [Redis](#) instance):

```
./gradlew build
```

To build and bundle the distribution of Spring XD

```
./gradlew dist
```

The above gradle task creates `spring-xd-<version>.zip` binary distribution archive and `spring-xd-<version>-docs.zip` documentation archive files under `build/distributions`. This will also create a `build/dist/spring-xd` directory which is the expanded version of the binary distribution archive.

To just create the Spring XD expanded binary distribution directory

```
./gradlew copyInstall
```

The above gradle task creates the distribution directory under `build/dist/spring-xd`.

Once the binary distribution directory is created, please refer to [Getting Started](#) on how to run Spring XD.

B.2 IDE support

If you would like to work with the Spring XD code in your IDE, please use the following project generation depending on the IDE you use:

For Eclipse/Spring Tool Suite

```
./gradlew eclipse
```

For IntelliJ IDEA

```
./gradlew idea
```

Appendix C. Using MQTT Modules

C.1 Introduction

MQTT(MQ for telemetry transport) is a machine to machine connectivity protocol. It is a lightweight pub/sub protocol for devices where bandwidth and battery power are at a premium. This purpose of this document is to show you how to: enable the RabbitMQ MQTT plugin, setup a Spring XD MQTT source and Spring MQTT sink.

Note

This document assumes that you have a RabbitMQ installed and running. If you don't have RabbitMQ available already you can download it from <http://www.rabbitmq.com/download.html>.

Setting up MQTT on RabbitMQ

If you are using RabbitMQ 3.3.4 or above then the MQTT plugin is already included with your deployment, however it is inactive. To Activate:

1. Shutdown the Rabbit MQ instance
2. \$RABBIT_HOME/sbin/rabbitmq-plugins list

```
...
[ ] rabbitmq_federation_management 3.3.4
[E] rabbitmq_management            3.3.4
[e] rabbitmq_management_agent     3.3.4
[ ] rabbitmq_management_visualiser 3.3.4
[ ] rabbitmq_mqtt                 3.3.4
[ ] rabbitmq_shovel              3.3.4
[ ] rabbitmq_shovel_management    3.3.4
...
```

3. We see that the rabbit_mqtt does not have a [E] denoted next to it. Thus it is not enabled. Note: if you do see the [E] next to the rabbitmq_mqtt then your plugin is enabled and all you need to do is restart your RabbitMQ.

4. Now enable rabbit_mqtt plugin

- a. Run: \$RABBIT_HOME/sbin/rabbitmq-plugins enable rabbitmq_mqtt

- b. Run: \$RABBIT_HOME/sbin/rabbitmq-plugins list

```
...
[ ] rabbitmq_federation_management 3.3.4
[E] rabbitmq_management            3.3.4
[e] rabbitmq_management_agent     3.3.4
[ ] rabbitmq_management_visualiser 3.3.4
[E] rabbitmq_mqtt                 3.3.4
[ ] rabbitmq_shovel              3.3.4
[ ] rabbitmq_shovel_management    3.3.4
...
```

- c. Now we see that the rabbitmq_mqtt plugin is now active.

- d. Restart your RabbitMQ.

Rabbit MQTT Plugin settings

The MQTT plugin can be configured via the `rabbitmq.config` file and this is covered here: <http://www.rabbitmq.com/mqtt.html>. The settings for the MQTT plugin that Spring XD are concerned about are as follows:

1. `allow_anonymous` Determines if the user must supply a user name or password. If true then the plugin will use the `default_user` and `default_password` enumerated below. If false the Spring XD source or sink must provide the username and password Default: true
2. `default_user` If `allow_anonymous` is set to true then this will set the user for anonymous clients. Default: guest
3. `default_password` If `allow_anonymous` is set to true then this will set the password for anonymous clients. Default: guest
4. `exchange` - The name of the exchange that will route all MQTT messages to a the queues. Default: `amq.topic`
5. `tcp_listeners` - host and port that rabbit will monitor for MQTT messages. Default: 1883

Out of the box the Spring XD MQTT source and sink currently works with the MQTT plugin defaults without any configuration.

MQTT Source

When Spring XD deploys the MQTT source module, a message queue is created along with the necessary binding on RabbitMQ. The message queue that is created will have the name structure `[mqtt-subscription-][client_id][srcqos1]`. * `mqtt-subscription-` Queues created for MQTT subscribers will have names starting with `mqtt-subscription`. * `client-id` is the client-id specified by the MQTT source module, the default is `xd.mqtt.client.id` * `srcqos1` - The QoS level for the queue.

The MQTT source module also generates the binding from the `amq.topic` to the message queue via the routing key (topic). The default topic for the MQTT source module is `xd.mqtt.test`.

Example 1: Using defaults

To show this in detail let us create the following stream: `stream create mqtt-in --definition "mqtt|log" --deploy`. In this example the stream will retrieve MQTT messages from RabbitMQ and write the content to Spring XD's log. So on RabbitMQ a message queue named `mqtt-subscription-xd.mqtt.client.id.srcqos1` and a binding for the topic (routing key) `xd.mqtt.test` will be created.

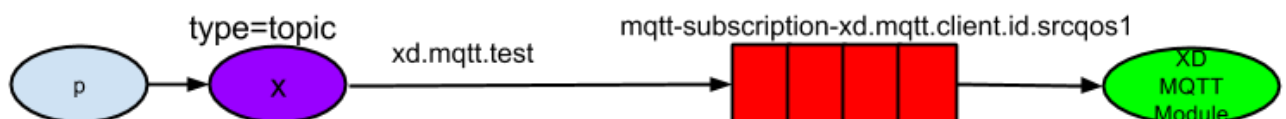

Thus any message published with the topic, `xd.mqtt.test` will be sent to the `mqtt-subscription-xd.mqtt.client.id.srcqos1` message queue and thus picked up by the Spring XD MQTT module and then written to log. So to exercise the stream created we can write the following:

```
stream create --name rabbittest --definition "http|rabbit --exchange='amq.topic' --
routingKey='''xd.mqtt.test'''" --deploy
http post --data 'hello world'
```

In the log you should see:

```
09:53:34,487 INFO MQTT Call: xd.mqtt.client.id.src sink.mqtt-in - hello world
```

Example 2: Monitoring different topics.

In this scenario we want to setup a MQTT Source Module to retrieve messages that may come in from different topics. So lets pretend that we want to monitor all the infusion machines at a medical facility. Our monitor wants to log all messages that notify us that a machine has completed its task or if a machine in need of maintenance.

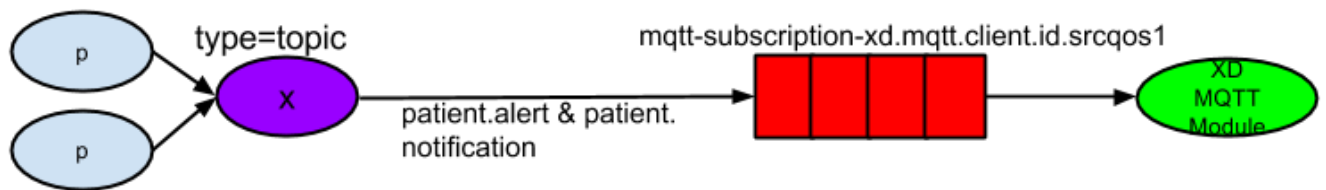

In this case it would look like this:

```
#Create a simulated device that will dispatch a patient alert message
stream create --name patientAlert --definition "http|rabbit --exchange='amq.topic' --
routingKey='''patient.alert'''" --deploy
#Create a simulated device that will dispatch a patient notification message
stream create --name patientNotification --definition "http --port=9005|rabbit --exchange='amq.topic' --
routingKey='''patient.notification'''" --deploy
# create our monitor that will capture the mqtt traffic.
stream create --name patientMonitor --definition "mqtt --topics=patient.alert,patient.notification |log"
--deploy
```

Now lets dispatch messages to both topics:

```
http post --target http://localhost:9005 --data 'infusion complete'
http post --data 'pump failure'
```

In the log you should see:

```
10:25:21,403 INFO MQTT Call: xd.mqtt.client.id.src sink.patientMonitor - infusion complete
10:25:46,226 INFO MQTT Call: xd.mqtt.client.id.src sink.patientMonitor - pump failure
```

MQTT Sink

The MQTT sink module will publish messages for a topic to the broker for a specific topic.

Example 1: Using defaults

In this example we will create a stream that will publish a message to topic using the defaults:

```
stream create mqtt-out --definition "http|mqtt" --deploy
stream create mqtt-in --definition"mqtt|log"
```

This mqtt-out stream will receive http messages to port 9000 on localhost and then the mqtt will publish the information to a rabbit instance on the localhost. The message will be routed to the queue (mqtt-

subscription-xd.mqtt.client.id.srcqos1) that was created by MQTT source module and then, the message will be delivered to the MQTT source module.

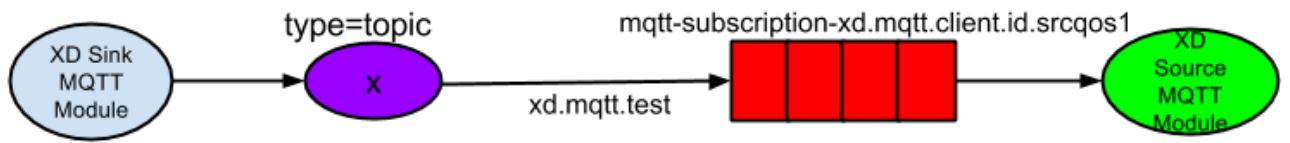

So the output will look something like this, if you execute a `http post --data 'hello world'`

```
14:03:57,340 INFO MQTT Call: xd.mqtt.client.id.src sink.mqtt-in - hello world
```

Appendix D. XD Shell Command Reference

Below is a reference list of all Spring XD specific commands you can use in the [XD Shell](#).

D.1 Configuration Commands

admin config info

Show the XD admin server being used.

```
admin config info
```

admin config server

Configure the XD admin server to use.

```
admin config server [--uri <uri>] [--username <username>] [--password [<password>]]
```

uri

the location of the XD Admin REST endpoint. **(default: http://localhost:9393/)**

username

the username for authenticated access to the Admin REST endpoint. **(default: ``)**

password

the password for authenticated access to the Admin REST endpoint (valid only with a username).

admin config timezone list

List all timezones.

```
admin config timezone list
```

admin config timezone set

Set the timezone of the Spring XD Shell (Not persisted).

```
admin config timezone set [--timeZone] <timeZone>
```

timeZone

the id of the timezone, You can obtain a list of timezone ids using 'admin config timezone list', If an invalid timezone id is provided, then 'Greenwich Mean Time' is being used. **(required)**

D.2 Runtime Commands

runtime containers

List runtime containers.

```
runtime containers
```

runtime modules

List runtime modules.

```
runtime modules [--containerId <containerId>] [--moduleId <moduleId>]
```

containerId

to filter by container id.

moduleId

to filter by module id.

D.3 Stream Commands

stream all destroy

Destroy all existing streams.

```
stream all destroy [--force [<force>]]
```

force

bypass confirmation prompt. **(default: false, or true if --force is specified without a value)**

stream all undeploy

Un-deploy all previously deployed stream.

```
stream all undeploy [--force [<force>]]
```

force

bypass confirmation prompt. **(default: false, or true if --force is specified without a value)**

stream create

Create a new stream definition.

```
stream create [--name] <name> --definition <definition> [--deploy [<deploy>]]
```

name

the name to give to the stream. **(required)**

definition

a stream definition, using XD DSL (e.g. "http --port=9000 | hdfs"). **(required)**

deploy

whether to deploy the stream immediately. **(default: false, or true if --deploy is specified without a value)**

stream deploy

Deploy a previously created stream.

```
stream deploy [--name] <name> [--properties <properties>] [--propertiesFile <propertiesFile>]
```

name

the name of the stream to deploy. **(required)**

properties

the properties for this deployment.

propertiesFile

the properties for this deployment (as a File).

stream destroy

Destroy an existing stream.

```
stream destroy [--name] <name>
```

name

the name of the stream to destroy. **(required)**

stream list

List created streams.

```
stream list
```

stream undeploy

Un-deploy a previously deployed stream.

```
stream undeploy [--name] <name>
```

name

the name of the stream to un-deploy. **(required)**

D.4 Job Commands

job all destroy

Destroy all existing jobs.

```
job all destroy [--force [<force>]]
```

force

bypass confirmation prompt. **(default: false, or true if --force is specified without a value)**

job all undeploy

Un-deploy all existing jobs.

```
job all undeploy [--force [<force>]]
```

force

bypass confirmation prompt. **(default: false, or true if --force is specified without a value)**

job create

Create a job.

```
job create [--name] <name> --definition <definition> [--deploy [<deploy>]]
```

name

the name to give to the job. **(required)**

definition

job definition using xd dsl . **(required)**

deploy

whether to deploy the job immediately. **(default: false, or true if --deploy is specified without a value)**

job deploy

Deploy a previously created job.

```
job deploy [--name] <name> [--properties <properties>] [--propertiesFile <propertiesFile>]
```

name

the name of the job to deploy. **(required)**

properties

the properties for this deployment.

propertiesFile

the properties for this deployment (as a File).

job destroy

Destroy an existing job.

```
job destroy [--name] <name>
```

name

the name of the job to destroy. **(required)**

job execution all stop

Stop all the job executions that are running.

```
job execution all stop [--force [<force>]]
```

force

bypass confirmation prompt. **(default: false, or true if --force is specified without a value)**

job execution display

Display the details of a Job Execution.

```
job execution display [--id] <id>
```

id

the id of the job execution. **(required)**

job execution list

List all job executions.

```
job execution list
```

job execution restart

Restart a job that failed or interrupted previously.

```
job execution restart [--id] <id>
```

id

the id of the job execution that failed or interrupted. **(required)**

job execution step display

Display the details of a Step Execution.

```
job execution step display [--id] <id> --jobExecutionId <jobExecutionId>
```

id

the id of the step execution. **(required)**

jobExecutionId

the job execution id. **(required)**

job execution step list

List all step executions for the provided job execution id.

```
job execution step list [--id] <id>
```

id

the id of the job execution. **(required)**

job execution step progress

Get the progress info for the given step execution.

```
job execution step progress [--id] <id> --jobExecutionId <jobExecutionId>
```

id

the id of the step execution. **(required)**

jobExecutionId

the job execution id. **(required)**

job execution stop

Stop a job execution that is running.

```
job execution stop [--id] <id>
```

id

the id of the job execution. **(required)**

job instance display

Display information about a given job instance.

```
job instance display [--id] <id>
```

id

the id of the job instance to retrieve.

job launch

Launch previously deployed job.

```
job launch [--name] <name> [--params <params>]
```

name

the name of the job to deploy.

params

the parameters for the job. **(default: ``)**

job list

List all jobs.

```
job list
```

job undeploy

Un-deploy an existing job.

```
job undeploy [--name] <name>
```

name

the name of the job to un-deploy. **(required)**

D.5 Module Commands

module compose

Create a virtual module.

```
module compose [--name] <name> --definition <definition> [--force [<force>]]
```

name

the name to give to the module. **(required)**

definition

module definition using xd dsl. **(required)**

force

force update if module already exists (only if not in use). **(default: false, or true if --force is specified without a value)**

module delete

Delete a virtual module.

```
module delete [--name] <name>
```

name

name of the module to delete, in the form 'type:name'. **(required)**

module info

Get information about a module.

```
module info [--name] <name> [--hidden [<hidden>]]
```

name

name of the module to query, in the form 'type:name'. **(required)**

hidden

whether to show 'hidden' options. **(default: false, or true if --hidden is specified without a value)**

module list

List all modules.

```
module list
```

module upload

Upload a new module.

```
module upload --type <type> --name <name> [--file] <file> [--force [<force>]]
```

type

the type for the uploaded module. **(required)**

name

the name for the uploaded module. **(required)**

file

path to the module archive. **(required)**

force

force update if module already exists (only if not in use). **(default: false, or true if --force is specified without a value)**

D.6 Metrics Commands

counter delete

Delete the counter with the given name.

```
counter delete [--name] <name>
```

name

the name of the counter to delete. **(required)**

counter display

Display the value of a counter.

```
counter display [--name] <name> [--pattern <pattern>]
```

name

the name of the counter to display. **(required)**

pattern

the pattern used to format the value (see DecimalFormat). **(default: <use platform locale>)**

counter list

List all available counter names.

```
counter list
```

field-value-counter delete

Delete the field-value-counter with the given name.

```
field-value-counter delete [--name] <name>
```

name

the name of the field-value-counter to delete. **(required)**

field-value-counter display

Display the value of a field-value-counter.

```
field-value-counter display [--name] <name> [--pattern <pattern>] [--size <size>]
```

name

the name of the field-value-counter to display. **(required)**

pattern

the pattern used to format the field-value-counter's field count (see DecimalFormat). **(default: <use platform locale>)**

size

the number of values to display. **(default: 25)**

field-value-counter list

List all available field-value-counter names.

```
field-value-counter list
```

aggregate-counter delete

Delete an aggregate counter.

```
aggregate-counter delete [--name] <name>
```

name

the name of the aggregate counter to delete. **(required)**

aggregate-counter display

Display aggregate counter values by chosen interval and resolution(minute, hour).

```
aggregate-counter display [--name] <name> [--from <from>] [--to <to>] [--lastHours <lastHours>] [--lastDays <lastDays>] [--resolution <resolution>] [--pattern <pattern>]
```

name

the name of the aggregate counter to display. **(required)**

from

start-time for the interval. format: 'yyyy-MM-dd HH:mm:ss'.

to

end-time for the interval. format: 'yyyy-MM-dd HH:mm:ss'. defaults to now.

lastHours

set the interval to last 'n' hours.

lastDays

set the interval to last 'n' days.

resolution

the size of the bucket to aggregate (minute, hour, day, month). **(default: hour)**

pattern

the pattern used to format the count values (see DecimalFormat). **(default: <use platform locale>)**

aggregate-counter list

List all available aggregate counter names.

```
aggregate-counter list
```

gauge delete

Delete a gauge.

```
gauge delete [--name] <name>
```

name

the name of the gauge to delete. **(required)**

gauge display

Display the value of a gauge.

```
gauge display [--name] <name> [--pattern <pattern>]
```

name

the name of the gauge to display. **(required)**

pattern

the pattern used to format the value (see DecimalFormat). (**default:** `<use platform locale>`)

gauge list

List all available gauge names.

```
gauge list
```

rich-gauge delete

Delete the richgauge.

```
rich-gauge delete [--name] <name>
```

name

the name of the richgauge to delete. (**required**)

rich-gauge display

Display Rich Gauge value.

```
rich-gauge display [--name] <name> [--pattern <pattern>]
```

name

the name of the richgauge to display value. (**required**)

pattern

the pattern used to format the richgauge value (see DecimalFormat). (**default:** `<use platform locale>`)

rich-gauge list

List all available richgauge names.

```
rich-gauge list
```

D.7 Http Commands

http get

Make GET request to http endpoint.

```
http get [--target] <target>
```

target

the URL to make the request to. (**default:** `http://localhost:9393`)

http post

POST data to http endpoint.

```
http post [--target] <target> [--data <data>] [--file <file>] [--contentType <contentType>]
```

target

the location to post to. (**default:** `http://localhost:9000`)

data

the text payload to post. exclusive with file. embedded double quotes are not supported if next to a space character.

file

filename to read data from. exclusive with data.

contentType

the content-type to use. file is also read using the specified charset. **(default: text/plain; Charset=UTF-8)**

D.8 Hadoop Configuration Commands

hadoop config fs

Sets the Hadoop namenode.

```
hadoop config fs [--namenode] <namenode>
```

namenode

namenode URL - can be file:///hdfs://<namenode>:<port>|webhdfs://<namenode>:<port>. **(required)**

hadoop config info

Returns basic info about the Hadoop configuration.

```
hadoop config info
```

hadoop config load

Loads the Hadoop configuration from the given resource.

```
hadoop config load [--location] <location>
```

location

configuration location (can be a URL). **(required)**

hadoop config props get

Returns the value of the given Hadoop property.

```
hadoop config props get [--key] <key>
```

key

property name. **(required)**

hadoop config props list

Returns (all) the Hadoop properties.

```
hadoop config props list
```

hadoop config props set

Sets the value for the given Hadoop property.

```
hadoop config props set [--property] <property>
```

property

what to set, in the form <name=value>. **(required)**

D.9 Hadoop FileSystem Commands

hadoop fs cat

Copy source paths to stdout.

```
hadoop fs cat [--path] <path>
```

path

file name to be shown. **(required)**

hadoop fs chgrp

Change group association of files.

```
hadoop fs chgrp [--recursive [<recursive>]] --group <group> [--path] <path>
```

recursive

whether with recursion. **(default: false, or true if --recursive is specified without a value)**

group

group name. **(required)**

path

path of the file whose group will be changed. **(required)**

hadoop fs chmod

Change the permissions of files.

```
hadoop fs chmod [--recursive [<recursive>]] --mode <mode> [--path] <path>
```

recursive

whether with recursion. **(default: false, or true if --recursive is specified without a value)**

mode

permission mode. **(required)**

path

path of the file whose permissions will be changed. **(required)**

hadoop fs chown

Change the owner of files.

```
hadoop fs chown [--recursive [<recursive>]] --owner <owner> [--path] <path>
```

recursive

whether with recursion. **(default: false, or true if --recursive is specified without a value)**

owner

owner name. **(required)**

path

path of the file whose ownership will be changed. **(required)**

hadoop fs copyFromLocal

Copy single src, or multiple srcs from local file system to the destination file system. Same as put.

```
hadoop fs copyFromLocal --from <from> --to <to>
```

from

source file names. **(required)**

to

destination path name. **(required)**

hadoop fs copyMergeToLocal

Takes a source directory and a destination file as input and concatenates files in src into the destination local file.

```
hadoop fs copyMergeToLocal --from <from> --to <to> [--endline [<endline>]]
```

from

source file names. **(required)**

to

destination path name. **(required)**

endline

whether add a newline character at the end of each file. **(default: false, or true if --endline is specified without a value)**

hadoop fs copyToLocal

Copy files to the local file system. Same as get.

```
hadoop fs copyToLocal --from <from> --to <to> [--ignoreCrc [<ignoreCrc>]] [--crc [<crc>]]
```

from

source file names. **(required)**

to

destination path name. **(required)**

ignoreCrc

whether ignore CRC. **(default: false, or true if --ignoreCrc is specified without a value)**

crc

whether copy CRC. **(default: false, or true if --crc is specified without a value)**

hadoop fs count

Count the number of directories, files, bytes, quota, and remaining quota.

```
hadoop fs count [--quota [<quota>]] --path <path>
```

quota

whether with quota information. **(default: false, or true if --quota is specified without a value)**

path

path name. **(required)**

hadoop fs cp

Copy files from source to destination. This command allows multiple sources as well in which case the destination must be a directory.

```
hadoop fs cp --from <from> --to <to>
```

from

source file names. **(required)**

to

destination path name. **(required)**

hadoop fs du

Displays sizes of files and directories contained in the given directory or the length of a file in case its just a file.

```
hadoop fs du [--dir <dir>] [--summary [<summary>]]
```

dir

directory to be listed. **(default: .)**

summary

whether with summary. **(default: false, or true if --summary is specified without a value)**

hadoop fs expunge

Empty the trash.

```
hadoop fs expunge
```

hadoop fs get

Copy files to the local file system.

```
hadoop fs get --from <from> --to <to> [--ignoreCrc [<ignoreCrc>]] [--crc [<crc>]]
```

from

source file names. **(required)**

to

destination path name. **(required)**

ignoreCrc

whether ignore CRC. **(default: false, or true if --ignoreCrc is specified without a value)**

crc

whether copy CRC. **(default: false, or true if --crc is specified without a value)**

hadoop fs ls

List files in the directory.

```
hadoop fs ls [--dir] <dir> [--recursive [<recursive>]]
```

dir

directory to be listed. **(default: .)**

recursive

whether with recursion. **(default: false, or true if --recursive is specified without a value)**

hadoop fs mkdir

Create a new directory.

```
hadoop fs mkdir [--dir] <dir>
```

dir

directory name. **(required)**

hadoop fs moveFromLocal

Similar to put command, except that the source localsrc is deleted after it's copied.

```
hadoop fs moveFromLocal --from <from> --to <to>
```

from

source file names. **(required)**

to

destination path name. **(required)**

hadoop fs mv

Move source files to destination in the HDFS.

```
hadoop fs mv --from <from> --to <to>
```

from

source file names. **(required)**

to

destination path name. **(required)**

hadoop fs put

Copy single src, or multiple srcs from local file system to the destination file system.

```
hadoop fs put --from <from> --to <to>
```

from

source file names. **(required)**

to

destination path name. **(required)**

hadoop fs rm

Remove files in the HDFS.

```
hadoop fs rm [--path] <path> [--skipTrash [<skipTrash>]] [--recursive [<recursive>]]
```

path

path to be deleted. **(default: .)**

skipTrash

whether to skip trash. **(default: false, or true if --skipTrash is specified without a value)**

recursive

whether to recurse. **(default: false, or true if --recursive is specified without a value)**

hadoop fs setrep

Change the replication factor of a file.

```
hadoop fs setrep --path <path> --replica <replica> [--recursive [<recursive>]] [--waiting [<waiting>]]
```

path

path name. **(required)**

replica

source file names. **(required)**

recursive

whether with recursion. **(default: false, or true if --recursive is specified without a value)**

waiting

whether wait for the replic number is eqal to the number. **(default: false, or true if --waiting is specified without a value)**

hadoop fs tail

Display last kilobyte of the file to stdout.

```
hadoop fs tail [--file] <file> [--follow [<follow>]]
```

file

file to be tailed. **(required)**

follow

whether show content while file grow. **(default: false, or true if --follow is specified without a value)**

hadoop fs text

Take a source file and output the file in text format.

```
hadoop fs text [--file] <file>
```

file

file to be shown. **(required)**

hadoop fs touchz

Create a file of zero length.

```
hadoop fs touchz [--file] <file>
```

file

file to be touched. **(required)**

D.10 Connecting to Kerberized Hadoop

If you have enabled Kerberos security in your Hadoop cluster it is possible to connect XD Shell, hdfs and hdfs-dataset sinks to it.

`hadoop.properties`

```
hadoop.security.authorization=true
spring.hadoop.security.authMethod=kerberos
spring.hadoop.security.userKeytab=/path/to/user.keytab
spring.hadoop.security.userPrincipal=user/host
spring.hadoop.security.namenodePrincipal=hdfs/host@DOMAIN
spring.hadoop.security.rmManagerPrincipal=yarn/host@DOMAIN
```

For both XD Container and XD Shell the config file is `config/hadoop.properties`.

Setting Principals

Principals for `spring.hadoop.security.namenodePrincipal` and `spring.hadoop.security.rmManagerPrincipal` would equal what are in use in Hadoop cluster.

Automatic Login

If you want to avoid running kerberos login commands manually, use `spring.hadoop.security.userKeytab` and `spring.hadoop.security.userPrincipal` properties respectively. Path to your kerberos keytab file needs to be a fully qualified path in your file system. Essentially this is a model used by internal Hadoop components to do automatic Kerberos logins.

Appendix E. Modules-Project-Migration

E.1 Introduction

With the release of Spring XD 1.1.0, creating and deploying a module has been greatly simplified. Features such as simplified pom (using the spring-xd-module-parent) or simplified build.gradle (using the spring-xd-module plugin) mean simpler dependency management and smaller build scripts to manage. Another new feature is that a user can execute the module upload command via the XD shell to register a custom module on the fly, vs. having to copy it to the modules subdirectory. The purpose of this appendix is to show how to upgrade an the existing 1.0.x style module project to a 1.1.0 style module project.

Note

If you are currently using the 1.0.x style of deploying modules, the format of deployment is still supported by 1.1.0.

Updating your Maven Project

Cleaning up

If you are using an assembly file for your POM, go ahead and remove it now. For example (From your project directory):

```
rm -rf src/assembly
```

Updating your POM file

Since we are using the XD Module Parent you can remove any XD dependencies as well as some of the boiler plate configurations. For example we can take the following pom.xml from a 1.0.x style module project:

```

<?xml version="1.0" encoding="UTF-8"?>
<project xsi:schemaLocation="http://maven.apache.org/POM/4.0.0 http://maven.apache.org/xsd/
maven-4.0.0.xsd" xmlns="http://maven.apache.org/POM/4.0.0"
  xmlns:xsi="http://www.w3.org/2001/XMLSchema-instance">
  <modelVersion>4.0.0</modelVersion>
  <groupId>org.springframework.xd.samples</groupId>
  <artifactId>payload-conversion</artifactId>
  <version>1.0.0.BUILD-SNAPSHOT</version>
  <name>Spring XD Sample - Payload type conversion example with a custom module</name>
  <packaging>jar</packaging>

  <prerequisites>
    <maven>2.2.1</maven>
  </prerequisites>

  <parent>
    <groupId>io.spring.platform</groupId>
    <artifactId>platform-bom</artifactId>
    <version>1.0.1.RELEASE</version>
    <relativePath/>
  </parent>

  <properties>
    <project.build.sourceEncoding>UTF-8</project.build.sourceEncoding>
    <spring.xd.version>1.1.0.RELEASE</spring.xd.version>
  </properties>

  <repositories>
    <repository>
      <id>spring-milestone</id>
      <url>http://repo.springsource.org/libs-milestone</url>
    </repository>
    <repository>
      <id>spring-release</id>
      <url>http://repo.springsource.org/libs-milestone</url>
    </repository>
  </repositories>

  <dependencies>
    <dependency>
      <groupId>org.springframework.xd</groupId>
      <artifactId>spring-xd-tuple</artifactId>
      <version>${spring.xd.version}</version>
      <scope>compile</scope>
    </dependency>
  </dependencies>

  <build>
    <plugins>
      <plugin>
        <artifactId>maven-assembly-plugin</artifactId>
        <version>2.4</version>
        <configuration>
          <descriptors>
            <descriptor>src/main/assembly/assembly.xml</descriptor>
          </descriptors>
        </configuration>
      </plugin>
    </plugins>
  </build>
</project>

```

and now replace it with a pom.xml that uses spring-xd-module-parent.

```

<?xml version="1.0" encoding="UTF-8"?>
<project xsi:schemaLocation="http://maven.apache.org/POM/4.0.0 http://maven.apache.org/xsd/
maven-4.0.0.xsd" xmlns="http://maven.apache.org/POM/4.0.0"
  xmlns:xsi="http://www.w3.org/2001/XMLSchema-instance">
  <modelVersion>4.0.0</modelVersion>
  <groupId>org.springframework.xd.samples</groupId>
  <artifactId>payload-conversion</artifactId>
  <version>1.0.0.BUILD-SNAPSHOT</version>
  <name>Spring XD Sample - Payload type conversion example with a custom module</name>

  <parent>
    <groupId>org.springframework.xd</groupId>
    <artifactId>spring-xd-module-parent</artifactId>
    <version>1.1.0.RELEASE</version>
  </parent>

  <repositories>
    <repository>
      <id>spring-io-release</id>
      <url>http://repo.spring.io/release</url>
    </repository>
    <repository>
      <id>jcenter</id>
      <url>http://jcenter.bintray.com</url>
    </repository>
  </repositories>
</project>

```

If there is a dependency that your project needs and is not included in the XD dependencies you can add the dependencies as you normally would. For example if we needed the feed adapter from Spring Integration for a source module, we would need to add the following to our pom.xml file:

```

<dependencies>
  <dependency>
    <groupId>org.springframework.integration</groupId>
    <artifactId>spring-integration-feed</artifactId>
    <version>4.1.2.RELEASE</version>
  </dependency>
</dependencies>

```

Updating your Gradle Project

Since we can now use the spring-xd-module plugin you can remove any XD dependencies from the build.gradle. For example we can take the following build.gradle from a 1.0.x style module project:

```
apply plugin: 'java'
apply plugin: 'eclipse'
apply plugin: 'idea'
apply plugin: 'io.spring.dependency-management'

repositories{
    maven { url 'http://repo.spring.io/libs-milestone' }
}

dependencyManagement {
    imports {
        mavenBom 'io.spring.platform:platform-bom:1.0.1.RELEASE'
    }
}

ext {
    springXdVersion = '1.1.0.RELEASE'
}

dependencies{
    compile "org.springframework.xd:spring-xd-tuple:$springXdVersion"
    runtime "org.slf4j:jcl-over-slf4j"
    runtime "org.slf4j:slf4j-log4j12"
    runtime "log4j:log4j"
    testCompile "junit:junit"
}

task dist(type: Copy) {
    destinationDir = file("${buildDir}")
    from { project.jar } {
        into 'dist/modules/processor/myTupleProcessor/lib/'
    }
    from { 'modules/' } {
        into 'dist/modules'
    }
}

buildscript {
    repositories {
        maven { url 'http://repo.spring.io/plugins-snapshot' }
    }
    dependencies {
        classpath 'io.spring.gradle:dependency-management-plugin:0.1.0.RELEASE'
    }
}

task wrapper(type: Wrapper) {
    description = 'Generates gradlew[.bat] scripts'
    gradleVersion = '1.11'
}
```

and replace it with the a build.gradle that uses the spring-xd-module plugin.

```

buildscript {
    repositories {
        maven { url "http://repo.spring.io/plugins-snapshot" }
        maven { url "http://repo.spring.io/release" }
        jcenter()
        maven { url "http://repo.spring.io/snapshot" }
        maven { url "http://repo.spring.io/milestone" }
    }
    dependencies {
        classpath("org.springframework.xd:spring-xd-module-plugin:1.1.0.RELEASE")
    }
}

ext {
    springXdVersion = '1.1.0.RELEASE'
    springIntegrationVersion = '4.1.2.RELEASE'
}

apply plugin: 'java'
apply plugin: 'eclipse'
apply plugin: 'idea'
apply plugin: 'spring-xd-module'

task wrapper(type: Wrapper) {
    gradleVersion = '1.12'
}

group = 'org.springframework.xd.samples'
version = '1.0.0.BUILD-SNAPSHOT'

description = "Spring XD processor module "

sourceCompatibility = 1.7
targetCompatibility = 1.7

repositories {
    maven { url "http://repo.spring.io/release" }
    mavenCentral()
    jcenter()
    maven { url "http://repo.spring.io/snapshot" }
    maven { url "http://repo.spring.io/milestone" }
}

```

If there is a dependency that your project needs and is not included in the XD dependencies you can add the dependencies as you normally would. For example if we needed the feed adapter from Spring Integration for a source module, we would need to add the following to our build.gradle file:

```

dependencies {
    compile "org.springframework.integration:spring-integration-feed:$springIntegrationVersion"
}

```

Building the Module Project

Maven

```
mvn clean package
```

Gradle

```
./gradlew clean test bootRepackage
```

Updating Configurations

Within your project the bean definition and property files in your resources directory will need to be moved to the resources/config directory. i.e.

```
mkdir src/resources/config
mv src/resources/module.xml src/resources/config
mv src/resources/module.properties src/resources/config
```

If you have more than one bean definition file you will need to consolidate it to one bean definition file. You may import other bean definition files, but only the main one can be in the top level `config` directory. The same applies if you have more than one properties file, you will need to consolidate them to one properties file.

Registering the module

In XD 1.1.x there is no need for explicit copying of your module into the modules directory. You can register your module from the XD Shell by executing the module upload command as shown below:

```
xd:>module upload --file [path-to]/payload-conversion-1.0.0.BUILD-SNAPSHOT.jar --name mymodule --type
processor
```

The example above will upload the `payload-conversion-1.0.0.BUILD-SNAPSHOT.jar` that was created after building the project. The module will be placed in the `xd.customModule.home/processor/mymodule` subdirectory. To verify that the module was successfully registered, in the shell execute a `module info type:module_name` command. For example:

```
xd:>module info processor:mymodule
Information about processor module 'mymodule':
```

Option Name	Description	Default	Type
outputType	how this module should emit messages it produces	<none>	MimeType
inputType	how this module should interpret messages it consumes	<none>	MimeType

Note

The uploaded module will be deployed to the `xd.customModule.home` directory of the admin server. If the XD deployment has containers that are not on the same machine as the admin server, they will not have access to it. The recommended workaround is to have the `xd.customModule.home` be a mounted directory that is shared between the machines.

To do a deeper dive on Module Project Development refer to [Creating a Module Project](#)